

QUANTUM TOPOLOGY WITHOUT TOPOLOGY

DANIEL TUBBENHAUER

EGNO

ABSTRACT. Quantum invariants are more than just topological invariants needed to tell objects apart. They build bridges between topology, algebra, number theory and quantum physics helping to transfer ideas, and stimulating mutual development. They also have a deep and interesting connection to representation theory, in particular, to representations of quantum groups.

The goal of these lecture notes is to explain how categorical algebra gives a way to study algebra and topology; in particular, how quantum invariants arise purely category theoretical.

CONTENTS

Introduction	2
1. Categories – definitions, examples and graphical calculus	3
2. Monoidal categories I – definitions, examples and graphical calculus	15
3. Monoidal categories II – more graphical calculus	29
4. Pivotal categories – definitions, examples and graphical calculus	39
5. Braided categories – definitions, examples and graphical calculus	54
6. Additive, linear and abelian categories – definitions and examples	73
7. Fiat and tensor categories – enrich the concepts from before	96
8. Fiat, tensor and fusion categories – definitions and classifications	110
9. Fusion and modular categories – definitions and graphical calculus	133
10. Quantum invariants – a diagrammatic approach	149
References	165

These lecture notes are a draft. In particular, the notes might change in the future by correcting typos, adding extra material or by improving the exposition. If you find typos or mistakes, then let me know, mentioning the version number:

v0.99, April 2, 2021.

Our main sources are [BK01], [BS11], [EGNO15], [HV19] and [TV17].

Acknowledgment. I would like to thank the participants of the class “Quantum invariants” at the Universität Zürich in the Spring 2020 for feedback and their patience with me being slow. Special thanks to Rea Dalipi, Davide Saccardo and Joel Schmitz for carefully reading these notes, spotting many typos and mistakes. Also I am in debt of the Corona crisis 2020, which started the project of writing these notes in the first place.

INTRODUCTION

Motivated by the Rosetta Stone, see Figure 1, here is the *categorical Rosetta stone*.

Category theory	Algebra	Topology	Physics	Logic
objects X	algebraic data X	manifold X	system X	proposition X
morphism $f: X \rightarrow Y$	relation $f: X \rightarrow Y$	cobordism $f: X \rightarrow Y$	process $f: X \rightarrow Y$	proof $f: X \rightarrow Y$
monoidal product $X \otimes Y$	product data $X \otimes Y$	disjoint union $X \otimes Y$	joint systems $X \otimes Y$	conjunction $X \otimes Y$
monoidal product $f \otimes g$	parallel relations $f \otimes g$	disjoint union $f \otimes g$	parallel process $f \otimes g$	parallel proofs $f \otimes g$

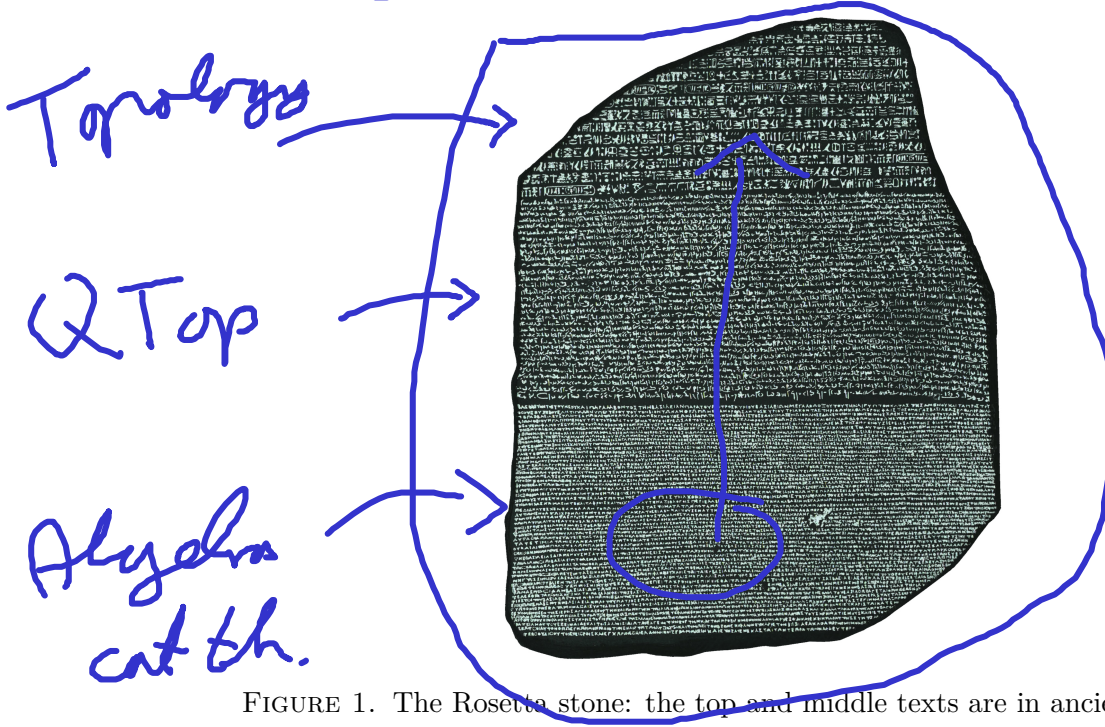

FIGURE 1. The Rosetta stone: the top and middle texts are in ancient Egyptian using hieroglyphic and Demotic scripts, respectively, while the bottom is in ancient Greek. The decree has only minor differences among the three versions, so the Rosetta stone became key to deciphering Egyptian hieroglyphs.

https://commons.wikimedia.org/wiki/File:Rosetta_Stone_BW.jpeg

In the 1980s we have witnessed the birth of a fascinating new mathematical field, often called quantum algebra or quantum topology. The most spectacular achievements of this was to combine various fields of mathematics and mathematical physics such as the theory of monoidal categories, von Neumann algebras and subfactors, Hopf algebras, representations of semisimple Lie algebras, quantum field theories, the topology of knots, *etc.*, all centered around the so-called quantum invariants of links.

In these lecture notes we focus our attention on the categorical aspects of the theory. Our goal is the construction and study of invariants of knots and links using techniques from categorical algebra only:

Goal. Use the left column of the categorical Rosetta stone to say something interesting about the others; especially with the focus on quantum invariants.

Summarized in a picture, the goal is to describe the categorical analog of:

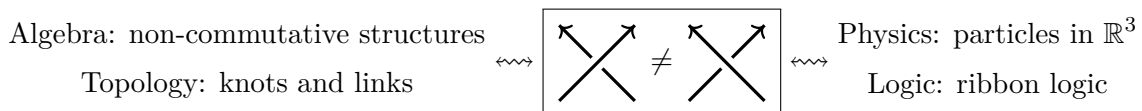

1. CATEGORIES – DEFINITIONS, EXAMPLES AND GRAPHICAL CALCULUS

The slogan for this first section is:

“Classical mathematics is based on sets, modern mathematics is based on categories.”

1A. A word about conventions.

Convention 1.1 Throughout, categories will be denoted by bold letters such as \mathbf{C} or \mathbf{D} , objects by X, Y etc. and morphisms by e.g. f, g . Moreover, functors are denoted by F, G etc., while natural transformations are denoted by Greek letters such as α . Further, for the sake of simplicity, we will write $X \in \mathbf{C}$ for objects and $(f: X \rightarrow Y) \in \mathbf{C}$ (or just $f \in \mathbf{C}$) for morphisms $f \in \text{Hom}_{\mathbf{C}}(X, Y)$, and also $gf = g \circ f$ for composition, which is itself denoted by \circ . (Note our reading conventions from right to left, called **operator notation**.) When we write these we assume that the expression makes sense.

Convention 1.2 There are some set theoretical issues with the definitions of some categories. For example, the objects of **Set** are all sets, which do not form a set. These issues are completely unimportant for the aims of these notes and ignored throughout.

Convention 1.3 Throughout, we will read any diagrammatics bottom to top, cf. [Example 1.11](#), and right to left, cf. (2-7). Moreover, the Feynman diagrams which we will use should be oriented, but we employ the convention that “No orientation on Feynman diagrams means upward oriented by default.”

Convention 1.4 \mathbb{k} will always denote some field, which we sometimes specialize to be e.g. of characteristic zero. If we need an algebraically closed field we write \mathbb{K} , and a general associative and unital ring such as \mathbb{Z} is denoted by \mathbb{S} . (A lot of constructions which we will see are stated over a field \mathbb{k} , but could also be formulated over \mathbb{S} . We find it however easier to think about a field \mathbb{k} and leave potential and easy generalizations to the reader.)

1B. **Basics.** We begin at the beginning:

Definition 1.5 A category \mathbf{C} consists of

- a collection of **objects** $\text{Ob}(\mathbf{C})$;
- a set of **morphisms** $\text{Hom}_{\mathbf{C}}(X, Y)$ for all $X, Y \in \mathbf{C}$;

such that

- (i) there exists a morphism $gf \in \text{Hom}_{\mathbf{C}}(X, Z)$ for all $f \in \text{Hom}_{\mathbf{C}}(X, Y)$ and $g \in \text{Hom}_{\mathbf{C}}(Y, Z)$;
- (ii) there exists a morphism id_X for all $X \in \mathbf{C}$ satisfying $\text{id}_Y f = f = f \text{id}_X$ for all $f \in \text{Hom}_{\mathbf{C}}(X, Y)$;
- (iii) we have $h(gf) = (hg)f$ whenever this makes sense.

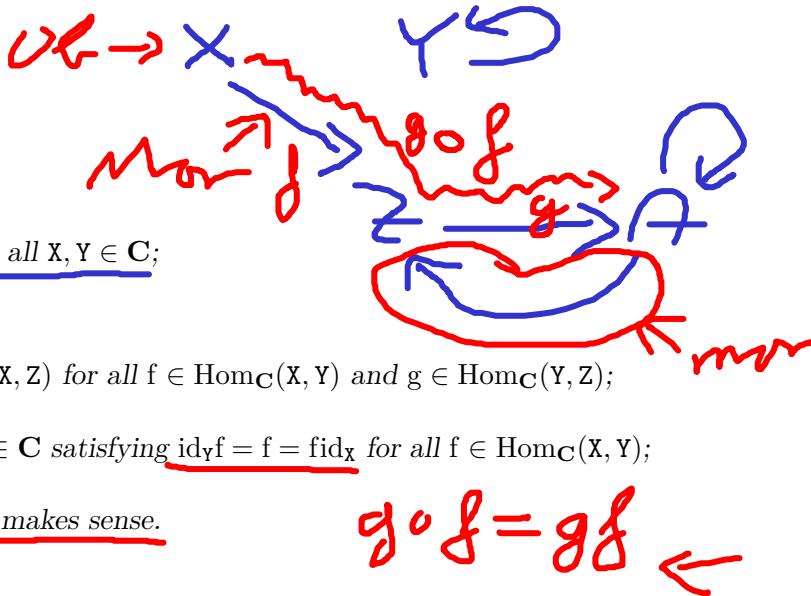

The morphism gf is called the **composition** of g after f , while the morphism id_X is called the **identity** on X . The last condition in [Definition 1.5](#) is called **associativity** of morphism

cat = discrete object "graph"

composition as it is equivalent to associativity (and we henceforth omit all brackets). In particular, $\text{End}_{\mathbf{C}}(\mathbf{X}) = \text{Hom}_{\mathbf{C}}(\mathbf{X}, \mathbf{X})$ is always a monoid. \rightarrow eg. $(\mathbb{N}, +)$

Example 1.6 Categories generalize many familiar concepts.

- (a) Categories generalize monoids: given a monoid M , there is a category \mathbf{M} with $\text{Ob}(\mathbf{M}) = \{\bullet\}$ (a dummy) and $\text{Hom}_{\mathbf{M}}(\bullet, \bullet) = M$, where composition is the multiplication in M . The picture for $M = \mathbb{Z}/4\mathbb{Z}$ being the cyclic group with four elements is

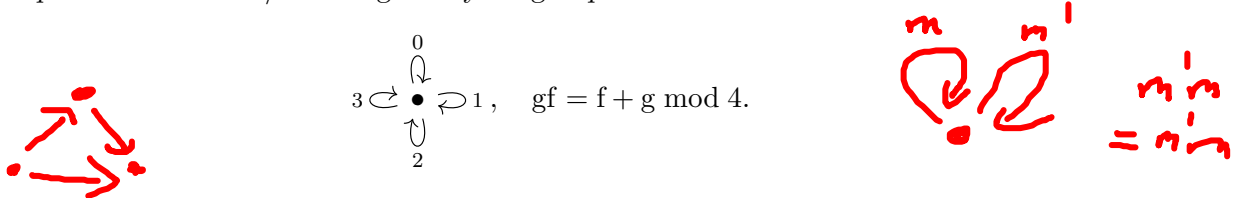

- (b) Categories generalize monoids in another way: there is a category \mathbf{Mon} whose objects are monoids and whose morphisms are monoid maps.

- (c) Categories generalize sets: there is a category \mathbf{Set} whose objects are sets and whose morphisms are maps.

- (d) Categories generalize vector spaces: there is a category $\mathbf{Vec}_{\mathbb{k}}$ whose objects are \mathbb{k} vector spaces and whose morphisms are \mathbb{k} linear maps. More general, the same construction gives the category of \mathbb{S} modules also, abusing notation a bit, denoted by $\mathbf{Vec}_{\mathbb{S}}$.

- (e) Categories generalize vector spaces in another way: there is a category $\mathbf{fdVec}_{\mathbb{k}}$ whose objects are finite dimensional \mathbb{k} vector spaces and whose morphisms are \mathbb{k} linear maps.

Remark 1.7 Note that categories are traditionally named after their objects, as e.g. \mathbf{Set} , but the main players are actually the morphisms.

Example 1.8 Later we often have categories which are denoted by $\mathbf{Mod}(A)$, which will be module categories of A . For now we observe that $\mathbf{Mod}(\mathbb{Z})$, the category of abelian groups, whose objects are abelian groups (equivalently, \mathbb{Z} modules $\mathbf{Vec}_{\mathbb{Z}}$) and whose morphisms are group homomorphisms, is a category.

Example 1.9 It is formally not correct to think of morphisms as maps. For example, there is a category \mathbf{A}_3 having three objects and three non-identity morphisms arranged via

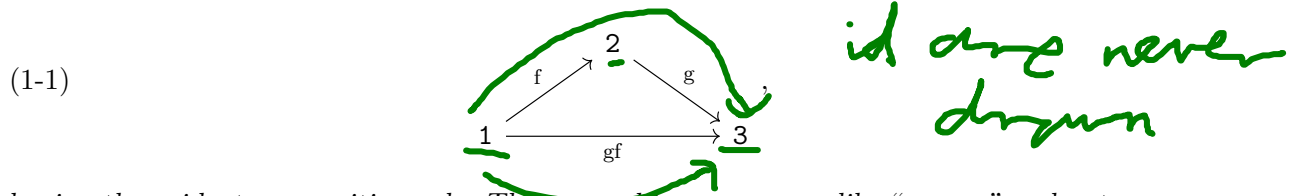

having the evident composition rule. Thus, morphisms are more like “arrows” and not maps.

Remark 1.10 In (1-1) we have seen the first **commutative diagram**, which in general is a certain oriented graph, in these lecture notes. This is always to be understood that all ways composing along the various edges of the graph give the same result. In (1-1) this is easy as the commutative diagram is a triangle and there are only two paths to compare, which are equal by definition. However, things can get more complicated, of course, cf. [Exercise 1.58](#).

Example 1.11 Very important for these lecture notes are the following examples. We will not define these formally, which is a bit painful, but rather stay with the informal, but handy, definition. (Later we will be able to give alternative and rigorous constructions.) ||||

(a) The category **1Cob** of 1 dimensional cobordisms. Its objects are 0 dimensional manifolds, a.k.a. points $\bullet^n = \bullet \dots \bullet$ for $n \in \mathbb{N}$, and its morphisms are 1 dimensional cobordisms between these, a.k.a. strands, illustrated as follows:

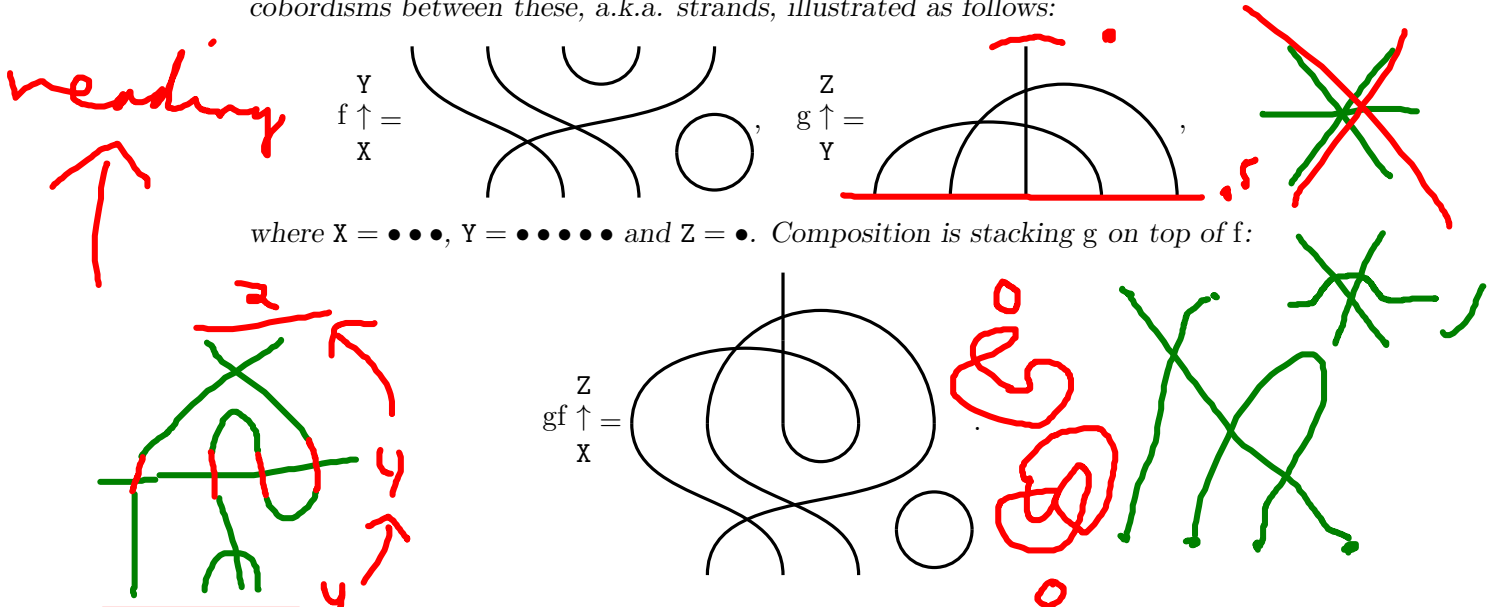

(b) The category **1Tan** of 1 dimensional tangles. This is the same as **1Cob**, but now remembering some embedding into \mathbb{R}^3 , illustrated as follows:

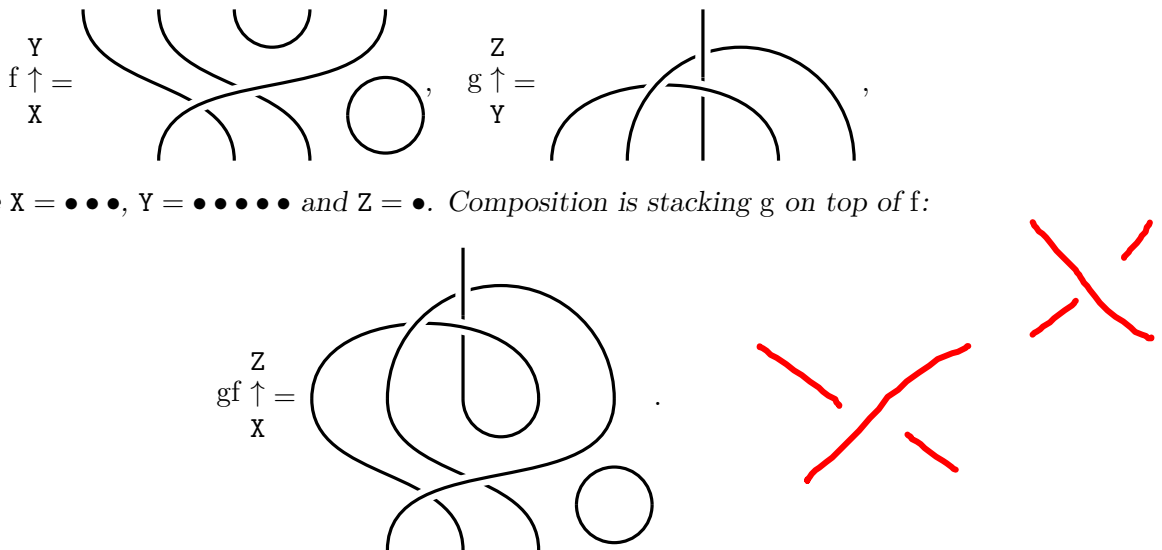

(c) The category **1State** of 1 dimensional states (sometimes called **oriented tangles**), which is the category of particles moving in space with objects being particles and morphisms being worldlines. Said otherwise, it is the same as **1Tan**, but now remembering some orientation, illustrated as follows:

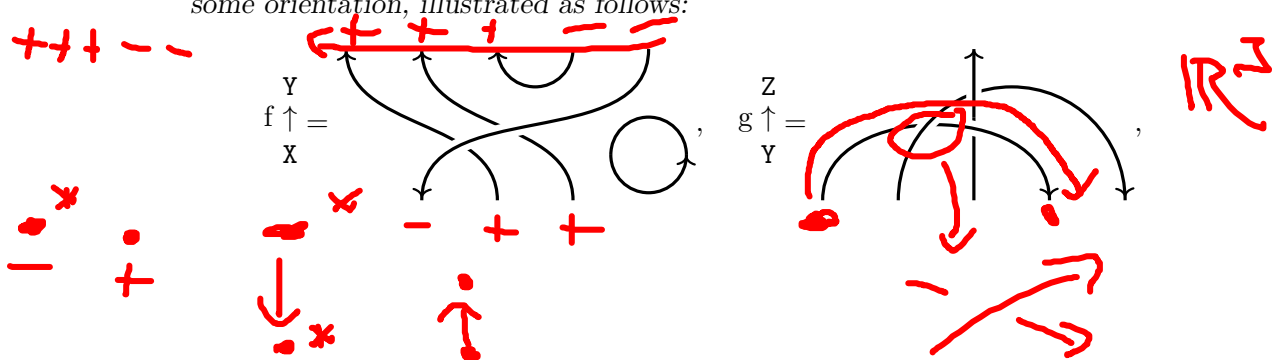

where $X = (\bullet^*) \bullet \bullet$, $Y = \bullet \bullet \bullet (\bullet^*) \bullet^*$ and $Z = \bullet$, a notation which will become clear in later sections. Composition is stacking g on top of f :

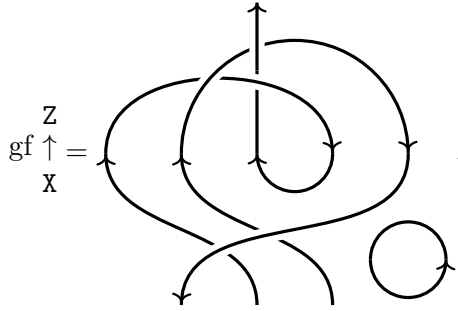

Definition 1.12 For any category \mathbf{C} , the pair category $\mathbf{C} \times \mathbf{C}$ is the category whose objects and morphisms are pairs of their corresponding types, i.e.

$$\text{Ob}(\mathbf{C} \times \mathbf{C}) = \{(X, Y) \mid X, Y \in \mathbf{C}\}, \quad \text{Hom}_{\mathbf{C} \times \mathbf{C}}((X, Y), (Z, A)) = \text{Hom}_{\mathbf{C}}(X, Z) \times \text{Hom}_{\mathbf{C}}(Y, A),$$

and whose composition is defined componentwise.

Definition 1.13 For any category \mathbf{C} , the opposite category \mathbf{C}^{op} is the category with the same objects and morphisms, but reversed composition:

$$(1-2) \quad \begin{array}{c|c|c} & \mathbf{C} & \mathbf{C}^{op} \\ \hline \text{Reversed } \circ? & \text{No} & \text{Yes} \end{array}$$

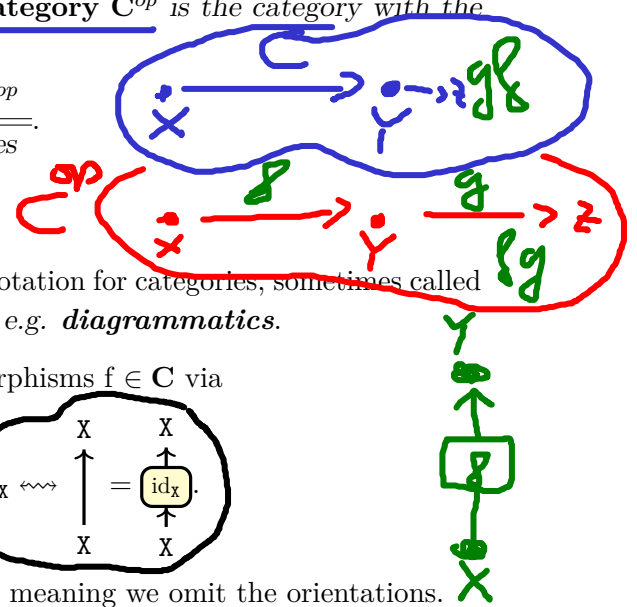

We also write f^{op} for opposite morphisms.

1C. Feynman diagrams. We now discuss a convenient notation for categories, sometimes called Feynman (or Penrose) diagrams, but we will also say e.g. diagrammatics.

Given a category \mathbf{C} we will denote objects $X \in \mathbf{C}$ and morphisms $f \in \mathbf{C}$ via

$$(1-3) \quad X \rightsquigarrow \begin{array}{c} X \\ \uparrow \\ X \end{array} \left(= X \uparrow \right), \quad f \rightsquigarrow \begin{array}{c} Y \\ \uparrow \boxed{f} \\ X \end{array}, \quad \text{id}_X \rightsquigarrow \begin{array}{c} X \\ \uparrow \\ X \end{array} = \begin{array}{c} X \\ \uparrow \boxed{\text{id}_X} \\ X \end{array}$$

From now on we use the convention from Convention 1.3, meaning we omit the orientations.

Remark 1.14 This notation is "Poincaré dual" to the one $f: X \rightarrow Y$ since, in diagrammatic notation, objects are strands and morphisms points, illustrated as coupons, see (1-3).

Composition is horizontal stacking, i.e.

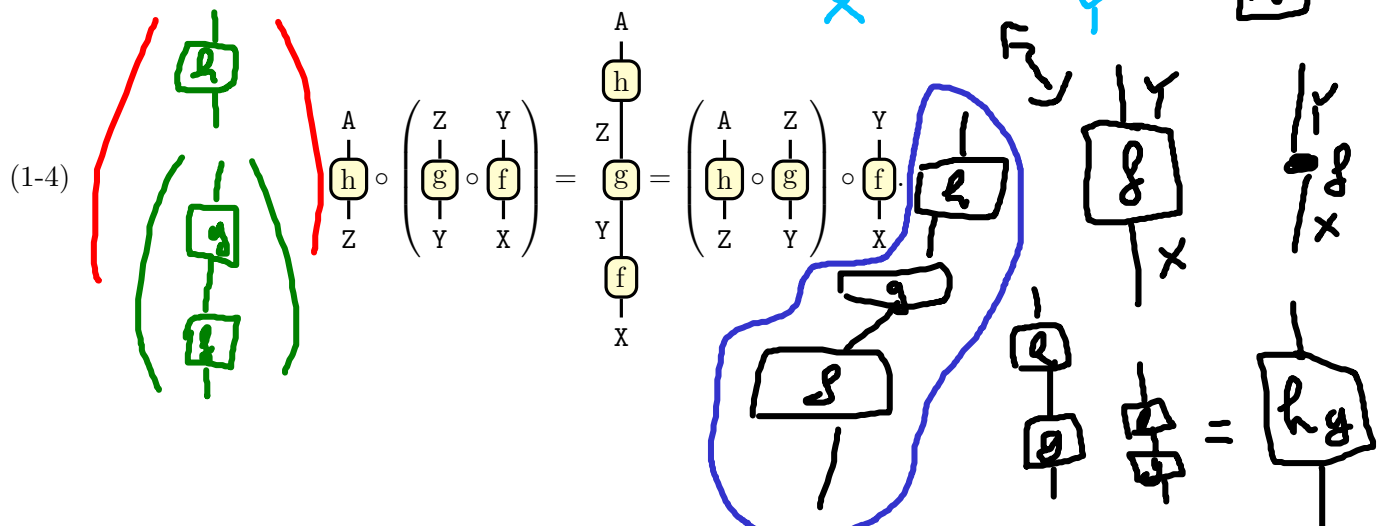

The formal rule of manipulation of these diagrams is:

- (1-5) “Two diagrams are equivalent if they are related by scaling.”

The following is (almost) evident.

Theorem 1.15 *The graphical calculus is consistent, i.e. two morphisms are equal if and only if their diagrams are related by (1-5).*

Proof. Note that associativity is implicitly used as we have only one way to illustrate $h(gf) = (hg)f$ as shown in (1-4), while

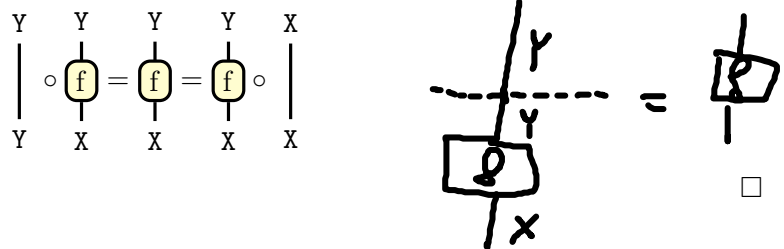

shows the identity axiom.

Remark 1.16 *Later, with more structure at hand, these diagrams will turn out to be a (quite useful) 2 dimensional calculus. For now they are rather 1 dimensional.*

1D. Maps between categories. A map between categories is:

Definition 1.17 A functor $F: C \rightarrow D$ between categories C and D is a map sending

- $X \in C$ to an object $F(X) \in D$;
- $(f: X \rightarrow Y) \in C$ to a morphism $(F(f): F(X) \rightarrow F(Y)) \in D$;

such that

- (i) composition is preserved, i.e. $F(gf) = F(g)F(f)$;
- (ii) identities are preserved, i.e. $F(id_X) = id_{F(X)}$.

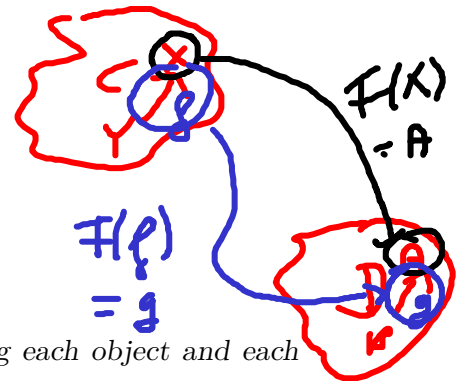

Example 1.18 There is an identity functor $Id_C: C \rightarrow C$, sending each object and each morphism to themselves.

A functor sends objects to objects and morphisms to morphisms in such a way that all relevant structures are preserved, and can thus be seen as a morphism between categories. Note further that one can compose functors in the evident way (with the identity functors being identities) and the result is again a functor:

Lemma 1.19 *If F and G are functors, then so is GF .*

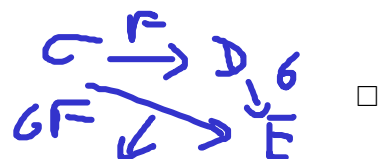

Example 1.20 Hence, we get the prototypical example of a category: **Cat** the category of categories, whose objects are categories and whose morphisms are functors.

Example 1.21 Functors generalize many familiar concepts.

- (a) *Functors generalize monoid maps: a functor $F: \mathbf{M} \rightarrow \mathbf{M}'$ between monoid categories \mathbf{M} and \mathbf{M}' , as in [Example 1.6.\(a\)](#), is a homomorphism of monoids.*
- (b) *Functors generalize models: a functor $F: \mathbf{M} \rightarrow \mathbf{Set}$ between a monoid category \mathbf{M} and \mathbf{Set} assigns a set $F(\bullet)$ to \bullet and an endomorphism $F(f)$ of $F(\bullet)$ to $f \in \mathbf{M}$, which can be seen as a concrete model of the underlying monoid M .*
- (c) *Functors generalize representations: a functor $F: \mathbf{M} \rightarrow \mathbf{Vec}_k$ between a monoid category \mathbf{M} and \mathbf{Vec}_k assigns a k vector space $F(\bullet)$ to \bullet and a k linear endomorphism $F(f)$ of $F(\bullet)$ to $f \in \mathbf{M}$, which can be seen as a representation of the underlying monoid M .*
- (d) *Functors generalize forgetting: there is a functor $\text{Forget}: \mathbf{Vec}_k \rightarrow \mathbf{Set}$ which forgets the underlying k linear structure.*
- (e) *Functors generalize free structures: there is a functor $\text{Free}: \mathbf{Set} \rightarrow \mathbf{Vec}_k$ for which $\text{Free}(X)$ is the free k vector space with basis X and $\text{Free}(f)$ is the k linear extension of f .*

Finally, note that any functor $F: \mathbf{C} \rightarrow \mathbf{D}$ gives rise to a natural map

$$\text{Hom}_{\mathbf{C}}(X, Y) \rightarrow \text{Hom}_{\mathbf{D}}(F(X), F(Y)), f \mapsto F(f),$$

which we often use without further comment. In particular:

Example 1.22 There are hom functors:

$$\text{Hom}_{\mathbf{C}}(X, \underline{\quad}) \circlearrowleft \mathbf{C} \rightarrow \mathbf{Set}, \begin{cases} Y \mapsto \text{Hom}_{\mathbf{C}}(X, Y), \\ f \mapsto (f \circ _), \end{cases} \quad \text{Hom}_{\mathbf{C}}(_, X): \mathbf{C}^{op} \rightarrow \mathbf{Set}, \begin{cases} Y \mapsto \text{Hom}_{\mathbf{C}}(Y, X), \\ f \mapsto (_ \circ f). \end{cases}$$

Hom(X, —)

Remark 1.23 A functor $F: \mathbf{C}^{op} \rightarrow \mathbf{D}$, such as $\text{Hom}_{\mathbf{C}}(_, X)$, is sometimes seen as a **contravariant functor** $F: \mathbf{C} \rightarrow \mathbf{D}$, meaning that $F(gf) = F(f)F(g)$ holds instead of $F(gf) = F(g)F(f)$.

1E. Maps between maps between categories. A map between functors is:

Definition 1.24 A natural transformation $\alpha: F \Rightarrow G$ between functors $F, G: \mathbf{C} \rightarrow \mathbf{D}$ is a collection of morphisms in \mathbf{D}

$$\{\alpha_X: F(X) \rightarrow G(X) \mid X \in \mathbf{C}\}$$

such that the following diagram commutes for all $f \in \mathbf{C}$:

$$(1-6) \quad \begin{array}{ccc} F(X) & \xrightarrow{F(f)} & F(Y) \\ \alpha_X \downarrow & & \downarrow \alpha_Y \\ G(X) & \xrightarrow{G(f)} & G(Y) \end{array} .$$

Remark 1.25 The diagram in (1-6) (which is the classical way of illustrating natural transformations, sometimes also called **natural** or **naturality**) is of course the same as

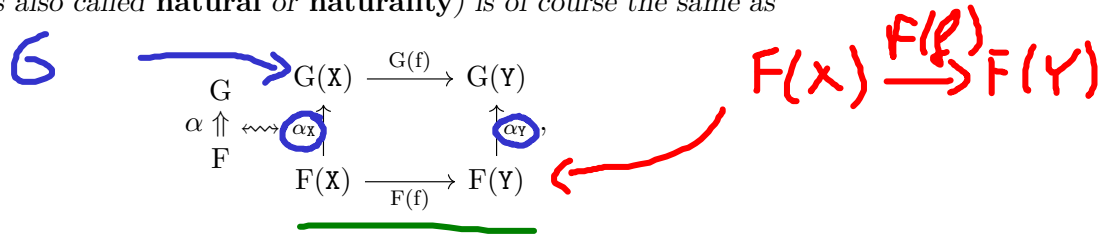

which, using our reading conventions, is saying that α can be seen as a morphism from F to G .

There is of course a composition of natural transformations, called the **vertical composition** and denoted by \circ , of natural transformations given by

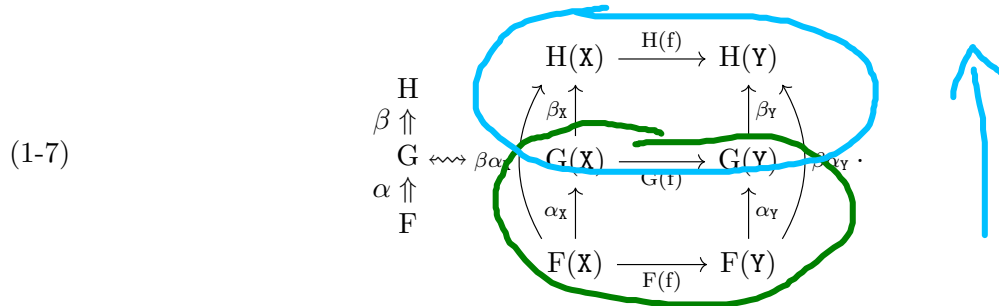

Example 1.26 There is an **identity natural transformation** $ID_F: F \rightarrow F$, $(ID_F)_X = id_X$.

Clearly:

$$F \xRightarrow{\alpha} G$$

Lemma 1.27 If α and β are natural transformations, then so is $\beta\alpha$. □

Example 1.28 By [Lemma 1.27](#), there is a category $\mathbf{Hom}(\mathbf{C}, \mathbf{D})$, the **category of functors** from \mathbf{C} to \mathbf{D} . Its objects are all such functors and its morphisms are natural transformations, with composition being vertical composition. A special case are **endofunctors**, whose category we denote by $\mathbf{End}(\mathbf{C}) = \mathbf{Hom}(\mathbf{C}, \mathbf{C})$, which will play an important role.

Example 1.29 Natural transformations generalize intertwiners (a.k.a. maps of representations): given two representations $F, G: \mathbf{M} \rightarrow \mathbf{Vec}_k$ as in [Example 1.21.\(c\)](#), a natural transformation between them would provide a commuting diagram

$$\begin{array}{ccc} F(\bullet) & \xrightarrow{F(f)} & F(\bullet) \\ \alpha_\bullet \downarrow & & \downarrow \alpha_\bullet \\ G(\bullet) & \xrightarrow{G(f)} & G(\bullet) \end{array} \Rightarrow F(f)\alpha_\bullet = \alpha_\bullet G(f),$$

where $F(\bullet)$ and $G(\bullet)$ are the k vector spaces associated to the representations, and $\alpha_\bullet: F(\bullet) \rightarrow G(\bullet)$ is a k linear map between them.

Example 1.30 Having a monoid category \mathbf{M} , the category $\mathbf{Hom}(\mathbf{M}, \mathbf{Vec}_k)$ can be identified with all representations of the underlying monoid.

1F. Some notions which we will need. Up next, some category theoretical notions.

Definition 1.31 Let $(f: X \rightarrow Y) \in \mathbf{C}$.

(i) f is called an **isomorphism** if there exists a $(g: Y \rightarrow X) \in \mathbf{C}$ such that

bijective

$$gf = \text{id}_X, \quad fg = \text{id}_Y. \quad g = f^{-1}$$

(ii) f is called a **monomorphism** or **monic** if it is left-cancellative, i.e.

injective

$$(fh = fi) \Rightarrow (h = i) \text{ for all } h, i \in \mathbf{C}.$$

$$\cancel{f}h = \cancel{f}i$$

(iii) f is called a **epimorphism** or **epic** if it is right-cancellative, i.e.

surjective

$$(hf = if) \Rightarrow (h = i) \text{ for all } h, i \in \mathbf{C}.$$

$$h\cancel{f} = i\cancel{f}$$

The following is the usual Yoga:

Lemma 1.32 If $f \in \mathbf{C}$ is an isomorphism, then $g \in \mathbf{C}$ as in [Definition 1.31.\(i\)](#) is unique. Moreover, such an f is monic and epic. \square

Thus, we can just denote the g as in [Definition 1.31.\(i\)](#) as f^{-1} and call it the inverse of f .

Example 1.33 In a lot of categories, e.g. **Set** or \mathbf{Vec}_k the three notions in [Definition 1.31](#) correspond to bijective, injective and surjective morphisms, respectively. However, this is slightly misleading: all non-identity morphisms in \mathbf{A}_3 , cf. [Example 1.9](#), are monic and epic, but none of these is an isomorphism, nor does being injective or surjective make sense.

Definition 1.34 Let $X, Y, Z \in \mathbf{C}$, and all morphisms are assumed to be in \mathbf{C} .

(i) X and Y are called isomorphic, denoted by $X \cong Y$, if there exists an isomorphism $f: X \rightarrow Y$.

(ii) X is called a subobject of Y , denoted by $X \hookrightarrow Y$, if there exists a monic morphism $f: X \rightarrow Y$.

(iii) Y is called a quotient of X , denoted by $X \twoheadrightarrow Y$, if there exists an epic morphism $f: X \rightarrow Y$.

(iv) X is called a subquotient of Z if there exists Y and a sequence $X \hookrightarrow Y \twoheadrightarrow Z$, i.e. if X is a quotient of a subobject of Z .

Note that fixing an isomorphism $f: X \rightarrow Y$ also gives us a unique isomorphism $f^{-1}: Y \rightarrow X$, a fact which we will use silently throughout.

Example 1.35 Note that e.g. being isomorphic depends on the category one is working in. Explicitly, $\mathbb{Z}/4\mathbb{Z}$ and $\mathbb{Z}/2\mathbb{Z} \times \mathbb{Z}/2\mathbb{Z}$ are clearly isomorphic in **Set**, but not in **Mod**(\mathbb{Z}) since the corresponding morphisms in **Set** are not homomorphisms of abelian groups.

Example 1.36 For $\mathbf{C}, \mathbf{D} \in \mathbf{Cat}$, by using [Definition 1.34.\(a\)](#), we get the notions of two categories being isomorphic, denoted by $\mathbf{C} \cong \mathbf{D}$.

Example 1.37 For $F, G \in \mathbf{Hom}(\mathbf{C}, \mathbf{D})$, by using [Definition 1.34.\(a\)](#), we get the notions of two functors being isomorphic. In particular, $F \in \mathbf{Hom}(\mathbf{C}, \mathbf{Set})$ is called **representable** (a particular nice functor), if its isomorphic to a hom functor as in [Example 1.22](#).

We will also use the notion \cong, \hookrightarrow and \twoheadrightarrow for the morphisms, e.g. $f: X \hookrightarrow Y$ means that f is monic. The following is clear.

Lemma 1.38 The three notions \cong, \hookrightarrow and \twoheadrightarrow are reflexive and transitive, meaning e.g.

$$(X \hookrightarrow Y \text{ and } Y \hookrightarrow Z) \Rightarrow (X \hookrightarrow Z), \text{ for all } X, Y, Z \in \mathbf{C},$$

and \cong is symmetric, thus, an equivalence relation. □

Definition 1.39 Let $\mathbf{C}, \mathbf{D} \in \mathbf{Cat}$.

- (i) \mathbf{C} is called a **subcategory** of \mathbf{D} , denoted by $\mathbf{C} \subset \mathbf{D}$, if $\text{Ob}(\mathbf{C}) \subset \text{Ob}(\mathbf{D})$, $\text{Hom}_{\mathbf{C}}(X, Y) \subset \text{Hom}_{\mathbf{D}}(X, Y)$ for all $X, Y \in \mathbf{C}$, and $\text{id}_X \in \mathbf{C}$ for all $X \in \mathbf{C}$.
- (ii) Such a subcategory is called **dense** if for all $Y \in \mathbf{D}$ there exists $X \in \mathbf{C}$ such that $X \cong Y$.
- (iii) Such a subcategory is called **full** if $\text{Hom}_{\mathbf{C}}(X, Y) = \text{Hom}_{\mathbf{D}}(X, Y)$ for all $X, Y \in \mathbf{C}$.

Example 1.40 We have $\text{fdVec}_{\mathbb{k}} \subset \text{Vec}_{\mathbb{k}}$, and $\text{fdVec}_{\mathbb{k}}$ is full, but not dense, in $\text{Vec}_{\mathbb{k}}$.

Using [Lemma 1.38](#) we can define:

Definition 1.41 Let $\overline{\text{Ob}(\mathbf{C})/\cong}$ be a choice of representatives of $\text{Ob}(\mathbf{C})/\cong$. Given a category \mathbf{C} , its **skeleton** $\text{Sk}(\mathbf{C})$ is the full subcategory with objects $\overline{\text{Ob}(\mathbf{C})/\cong}$.

Formally the skeleton depends on the choice of representatives. However, we can (and will) be sloppy and say that there is “the” skeleton:

Lemma 1.42 For any $\overline{\text{Ob}(\mathbf{C})/\cong}$, the corresponding skeletons are isomorphic. □

A category is called **skeletal**, if its isomorphic to its skeleton.



Example 1.43 The skeleton of $\text{fdVec}_{\mathbb{k}}$ can be identified with $\text{Mat}_{\mathbb{k}}$, i.e. $\text{Sk}(\text{fdVec}_{\mathbb{k}}) \cong \text{Mat}_{\mathbb{k}}$. Here $\text{Mat}_{\mathbb{k}}$ is the category of matrices whose objects are natural numbers $m, n \in \mathbb{N}$, and $\text{Hom}_{\text{Mat}_{\mathbb{k}}}(\mathbf{n}, \mathbf{m}) = \text{Mat}_{m \times n}(\mathbb{k})$, i.e. matrices with entries in \mathbb{k} , and $\text{Mat}_{\mathbb{k}}$ is skeletal.

Definition 1.44 We let $K_0(\mathbf{C}) = \overline{\text{Ob}(\mathbf{C})/\cong}$, and call it the **Grothendieck classes** of \mathbf{C} . Elements in $K_0(\mathbf{C})$ are **Grothendieck classes** of $X \in \mathbf{C}$ and denoted by $[X]$.

We think of $K_0(\mathbf{C})$ as capturing all information about the objects of \mathbf{C} . For an arbitrary category $K_0(\mathbf{C})$ is just a set, but when \mathbf{C} has more structure, then so does $K_0(\mathbf{C})$.

Example 1.45 We can identify $K_0(\text{fdVec}_{\mathbb{k}}) \xrightarrow{\cong} \mathbb{N}$ as sets, the map being $[\mathbb{k}^n] \mapsto n$ since any $X \in \text{fdVec}_{\mathbb{k}}$ is isomorphic to \mathbb{k}^n for some $n \in \mathbb{N}$.

$$V \mapsto \dim V$$

same info.

Note that \mathbf{fdVec}_k and \mathbf{Mat}_k in some sense contain the same information, but they are not isomorphic: $\mathbf{fdVec}_k \not\cong \mathbf{Mat}_k$. This is due to the fact that isomorphisms of categories give bijections on objects. But recall that we “do not care about objects”. So maybe asking

$$\text{Id}_C = GF, \quad FG = \text{Id}_D$$

is a bit too much. This motivates the following “correct” notion of equivalence of categories:

Definition 1.46 Let $C, D \in \mathbf{Cat}$. The categories C and D are called equivalent denoted by $C \simeq D$, if there exists $F: C \rightarrow D$ and $G: D \rightarrow C$ such that

$$\text{Id}_C \cong GF, \quad FG \cong \text{Id}_D,$$

where \cong is taken in $\mathbf{Hom}(C, D)$, cf. [Example 1.37](#)

Remark 1.47 In Feynman diagrammatics for $\mathbf{Hom}(C, D)$ there is a nice interpretation of equivalence. To this end, let us fix

$$\iota: \text{Id}_C \xrightarrow{\cong} GF, \quad \varepsilon: FG \xrightarrow{\cong} \text{Id}_D,$$

sometimes also called **unit** and **counit**. Then these can be pictured as caps and cups

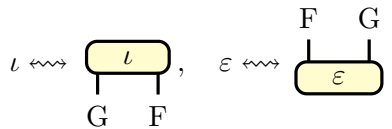

where we have not drawn strands for the identity functors, by the usual convention. Later, with more structure at hand, we will revisit such diagrams, which then become topological objects.

Functors as in [Definition 1.46](#) are called **equivalences** and they are **quasi-inverse** to each other. Clearly, isomorphic categories are equivalent, but the converse is not true:

Example 1.48 Any category C is equivalent to its skeleton, but not necessary isomorphic. Explicitly, $\mathbf{fdVec}_k \simeq \mathbf{Mat}_k$, but $\mathbf{fdVec}_k \not\cong \mathbf{Mat}_k$.

Example 1.49 The category \mathbf{fSet} , which is the full subcategory of \mathbf{Set} with objects being finite sets, is not skeletal.

fin sets with only \cong

Example 1.50 The category \mathbf{fSet}^{\cong} , which is the subcategory of \mathbf{fSet} with the same objects, but only bijections, is not skeletal. Its skeleton is \mathbf{Sym}^{top} which is the subcategory of $\mathbf{1Cob}$, cf. [Example 1.11.\(a\)](#), with the same objects but only cobordisms without Morse points (a.k.a. no turnbacks). A typical diagram in \mathbf{Sym}^{top} is a permutation diagram, e.g.

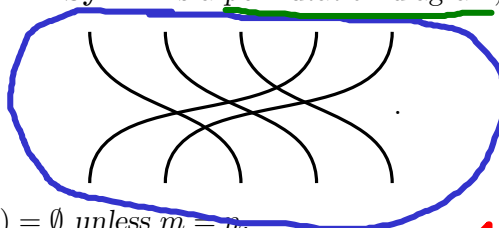

Note that $\text{Hom}_{\mathbf{Sym}^{top}}(\bullet^m, \bullet^n) = \emptyset$ unless $m = n$.

Let us also note:



Lemma 1.51 Any functor $F \in \mathbf{Hom}(\mathbf{C}, \mathbf{D})$ induces a map

$$K_0(F): K_0(\mathbf{C}) \rightarrow K_0(\mathbf{D}), [X] \mapsto [F(X)].$$

Further, if F is an equivalence, then $K_0(F)$ is an isomorphism. \square

If one wants to check whether two categories are equivalent one almost always uses:

Proposition 1.52 A functor $F: \mathbf{C} \rightarrow \mathbf{D}$ is an equivalence if and only if

- it is dense (also called **essentially surjective**), i.e.

for all $Y \in \mathbf{D}$ there exist $X \in \mathbf{C}$ such that $F(X) \cong Y$;

bij onto \cong

- it is faithful, i.e.

$$\text{Hom}_{\mathbf{C}}(X, Y) \hookrightarrow \text{Hom}_{\mathbf{D}}(F(X), F(Y)) \text{ for all } X, Y \in \mathbf{C};$$

- it is full, i.e.

$$\text{Hom}_{\mathbf{C}}(X, Y) \twoheadrightarrow \text{Hom}_{\mathbf{D}}(F(X), F(Y)) \text{ for all } X, Y \in \mathbf{C}.$$

inj sur

bij

If a functor is full and faithful, then we also say its **fully faithful**.

Proof. The proof is what is called **diagram chasing**.

\Rightarrow . Let $(F, G, \iota, \varepsilon)$ as in [Remark 1.47](#) define the equivalence. By $\varepsilon_X: FG(Y) \xrightarrow{\cong} Y$ we see that F is dense. To see that F is faithful consider the commuting diagram

$$\begin{array}{ccc} X & \xrightarrow[\iota_X]{\cong} & GF(X) \\ \text{f or g} \downarrow & & \downarrow GF(\text{f}) \text{ or } GF(\text{g}) \\ X' & \xrightarrow[\iota_{X'}]{\cong} & GF(X') \end{array}$$

Assuming that $GF(\text{f}) = GF(\text{g})$, by [Exercise 1.59](#), implies that $\text{f} = \text{g}$ which in turn implies that F is faithful. Very similar arguments, using again [Exercise 1.59](#), show that F is full.

\Leftarrow . Suppose that F is dense and fully faithful, so we need to construct the quadruple $(F, G, \iota, \varepsilon)$ as in [Remark 1.47](#). First, using density, we find an object $G(Y)$ for all $Y \in \mathbf{D}$ as well as an isomorphism $\varepsilon_Y: FG(Y) \xrightarrow{\cong} Y$. Thus, for each $\text{f}: Y \rightarrow Y'$ we find a unique solution $GF(\text{f})$ to make

$$\begin{array}{ccc} FG(Y) & \xrightarrow[\varepsilon_Y]{\cong} & Y \\ FG(\text{f}) \downarrow & & \downarrow \text{f} \\ FG(Y') & \xrightarrow[\varepsilon_{Y'}]{\cong} & Y' \end{array}$$

commutative, by [Exercise 1.59](#). Hence, fully faithfulness of F defines us $G(\text{f})$. Scrutiny of this construction actually show that $G(Y)$ and $G(\text{f})$, and ε_Y assemble into a functor and a natural transformation, respectively. It remains to construct ι_X (and prove that these give rise to a natural transformation), which can be done in a similar fashion. \square

Definition 1.53 A category \mathbf{C} is called **concrete** if it admits a faithful functor, called its **realization**, $R: \mathbf{C} \rightarrow \mathbf{Set}$.

Example 1.54 The functor *Forget*, cf. [Example 1.21.\(d\)](#), realizes \mathbf{Vec}_k as a concrete category.

The following is arguably the most important statement in classical category theory and known as the **Yoneda lemma**. We will not need it, and only give a reference for its proof, but any text on category theory without it feels like “missing something”. So here we go:

Theorem 1.55 For any $F \in \mathbf{Hom}(\mathbf{C}, \mathbf{Set})$ and any $X \in \mathbf{C}$ there is a bijection

$$\mathbf{Hom}_{\mathbf{Hom}(\mathbf{C}, \mathbf{Set})}(\mathbf{Hom}_{\mathbf{C}}(X, -), F) \rightarrow F(X), \quad (\alpha: \mathbf{Hom}_{\mathbf{C}}(X, -) \Rightarrow F) \mapsto \alpha_X(\text{id}_X).$$

Moreover, this correspondence is natural in both F and X .

Proof. Proofs tend to be a bit technical and longish. We do not need the Yoneda lemma much, so we refer to [Ma98, Section III.2]. \square

As a consequence we have the Yoneda embedding(s) given by the Yoneda functor(s):

Proposition 1.56 Fix $\mathbf{C} \in \mathbf{Cat}$. We have fully faithful functors

$$\begin{cases} Y: \mathbf{C} \rightarrow \mathbf{Hom}(\mathbf{C}^{op}, \mathbf{Set}), \\ X \mapsto \mathbf{Hom}_{\mathbf{C}}(-, X), (f: X \rightarrow Y) \mapsto (f \circ -: \mathbf{Hom}_{\mathbf{C}}(-, X) \rightarrow \mathbf{Hom}_{\mathbf{C}}(-, Y), g \mapsto fg), \\ Y^{op}: \mathbf{C}^{op} \rightarrow \mathbf{Hom}(\mathbf{C}, \mathbf{Set}), \\ X \mapsto \mathbf{Hom}_{\mathbf{C}}(X, -), (f: X \rightarrow Y)^{op} \mapsto (- \circ f: \mathbf{Hom}_{\mathbf{C}}(Y, -) \rightarrow \mathbf{Hom}_{\mathbf{C}}(X, -), g \mapsto gf). \end{cases}$$

"Any \mathbf{C} is of the form $\mathbf{Hom}(\mathbf{C}^{op}, \mathbf{Set})$ "

Hence, \mathbf{C} and \mathbf{C}^{op} are full subcategories of $\mathbf{Hom}(\mathbf{C}^{op}, \mathbf{Set})$ respectively of $\mathbf{Hom}(\mathbf{C}, \mathbf{Set})$.

Proof. From the construction of the Yoneda functors we see that we have injections

$$(1-8) \quad \begin{aligned} \mathbf{Hom}_{\mathbf{C}}(X, Y) &\hookrightarrow \mathbf{Hom}_{\mathbf{Hom}(\mathbf{C}, \mathbf{Set})}(\mathbf{Hom}_{\mathbf{C}}(X, -), \mathbf{Hom}_{\mathbf{C}}(Y, -)), \\ \mathbf{Hom}_{\mathbf{C}}(X, Y) &\hookrightarrow \mathbf{Hom}_{\mathbf{Hom}(\mathbf{C}, \mathbf{Set})}(\mathbf{Hom}_{\mathbf{C}}(-, X), \mathbf{Hom}_{\mathbf{C}}(-, Y)). \end{aligned}$$

Further, **Theorem 1.55** implies that every natural transformation between represented functors arises in this way, showing that (1-8) are bijections. Comparing this to the second and third bullet points in **Proposition 1.52**, which define the notion of being fully faithful, shows the claim. \square

Example 1.57 For the category \mathbf{A}_3 from **Example 1.9** the Yoneda functor Y^{op} associates

$$Y(1) = \left(\mathbf{Hom}_{\mathbf{A}_3}(1, -): \mathbf{A}_3 \rightarrow \mathbf{Set}, \begin{cases} 1 \mapsto \{\text{id}_1\}, 2 \mapsto \{f\}, 3 \mapsto \{gf\} \\ f \mapsto (\text{id}_1 \mapsto f), g \mapsto (\text{id}_2 \mapsto g), gf \mapsto (\text{id}_1 \mapsto gf), \end{cases} \right),$$

etc., which identifies $(\mathbf{A}_3)^{op}$ with the functors of the form $\mathbf{Hom}_{\mathbf{A}_3}(i, -)$ for $i \in \{1, 2, 3\}$.

1G. Exercises.

Exercise 1.58 Given the following diagram in some category.

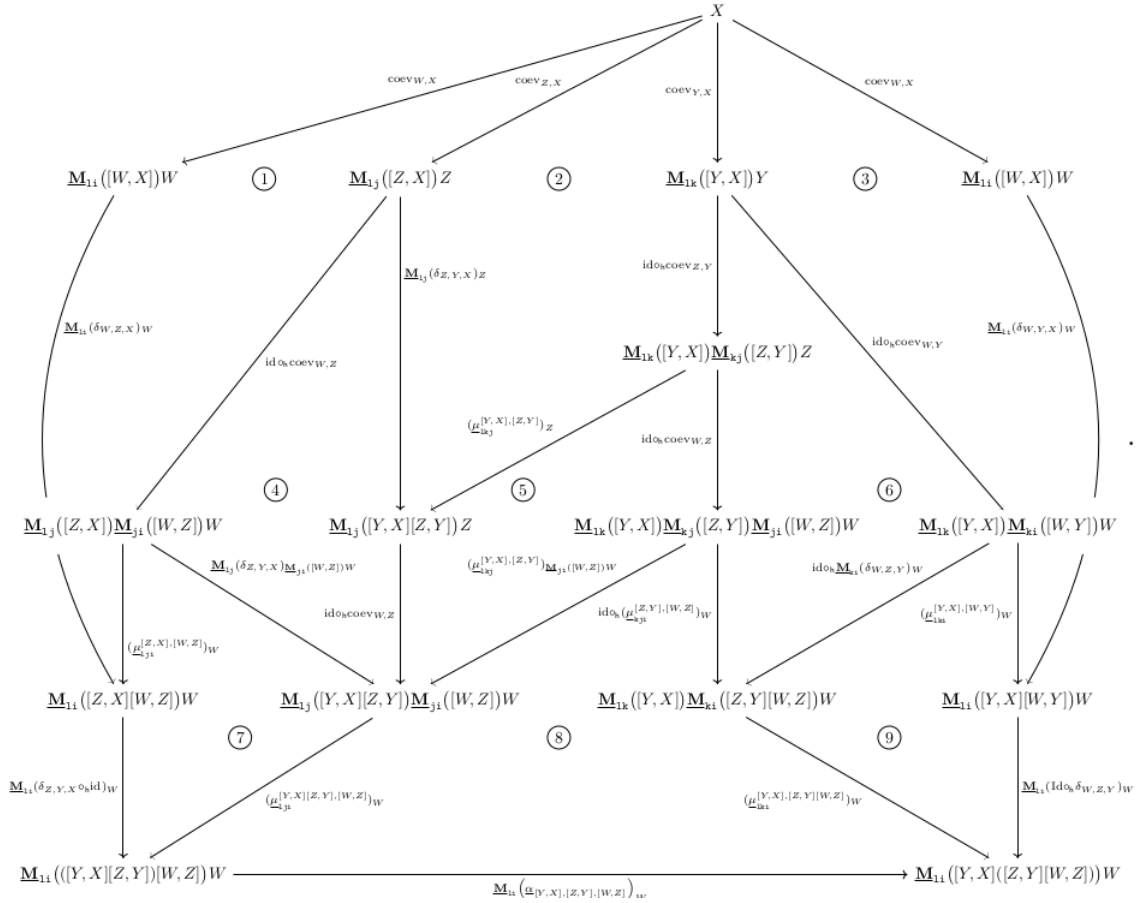

If all the numbered subdiagrams commute, does it follow that the diagram itself is commutative?

Exercise 1.59 Given $f: X \rightarrow Y$ and fixed isomorphisms $X \cong X'$ and $Y \cong Y'$, there exists a unique $f': X' \rightarrow Y'$ such that any, or, equivalently, all, of the following diagrams commute:

$$\begin{array}{cccc}
 X \xrightarrow{\cong} Y & X \xleftarrow{\cong} Y & X \xrightarrow{\cong} Y & X \xleftarrow{\cong} Y \\
 f \downarrow & f \downarrow & f \downarrow & f \downarrow \\
 X' \xrightarrow{\cong} Y' & X' \xrightarrow{\cong} Y' & X' \xleftarrow{\cong} Y' & X' \xleftarrow{\cong} Y'
 \end{array}$$

Exercise 1.60 Consider the following statement: “In every concrete category \mathbf{C} with realization R , a morphism $f \in \mathbf{C}$ is an isomorphism $\Leftrightarrow R(f) \in \mathbf{Set}$ is an isomorphism.” Is this claim true or false? Is at least one of the two directions, meaning \Rightarrow or \Leftarrow , correct?

Exercise 1.61 What is the skeleton of the category \mathbf{fSet} from Example 1.49?

Exercise 1.62 Let $F \in \mathbf{Hom}(\mathbf{C}, \mathbf{D})$ be an equivalence of categories. Show that $f \in \mathbf{C}$ is monic (or epic, or an isomorphism) if and only if $F(f) \in \mathbf{D}$ is monic (or epic, or an isomorphism).

2. MONOIDAL CATEGORIES I – DEFINITIONS, EXAMPLES AND GRAPHICAL CALCULUS

We have seen Feynman diagrams for categories, but they are a 1 dimensional. So:

What are the right axioms to get a 2 dimensional diagrammatic calculus?

2A. **Motivating example.** If one considers the vertical composition of natural transformations (1-7), then it seems there should be a second, horizontal composition \otimes :

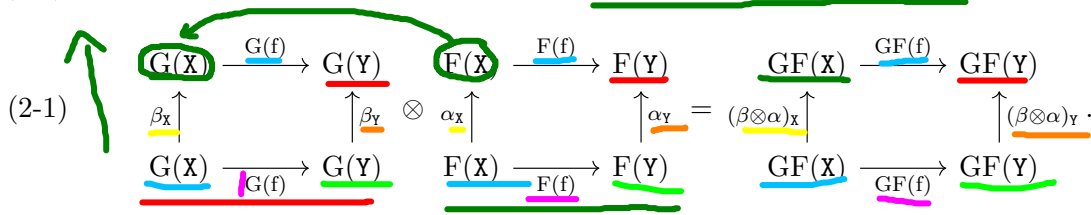

As we will see, there is indeed such a second composition.

\Rightarrow 2-dim calculus

2B. **A more down to earth motivating example.** Recall from Definition 1.12 that we can form the pair category $\mathbf{Set} \times \mathbf{Set}$. Note that we have a functor



$\otimes: \mathbf{Set} \times \mathbf{Set} \rightarrow \mathbf{Set}, \quad \otimes((X, Y)) = X \otimes Y = X \times Y, \quad \otimes((f, g)) = f \otimes g = f \times g,$

where we already use the usual standard notation, meaning writing e.g. $X \otimes Y$ instead of $\otimes((X, Y))$, for these kinds of functors.

The functor \otimes is actually a bit better: it is a **bifunctor**. This means that it satisfies an identity rule and the interchange law, i.e.

(2-2)
$$\text{id}_X \otimes \text{id}_Y = \text{id}_{X \otimes Y}, \quad (gf) \otimes (kh) = (g \otimes k)(f \otimes h).$$

Note the following:

- This is only weakly associative, i.e.

$$X \otimes (Y \otimes Z) \not\cong (X \otimes Y) \otimes Z, \quad \text{but rather } X \otimes (Y \otimes Z) \cong (X \otimes Y) \otimes Z,$$

because the set $X \otimes (Y \otimes Z)$ contains elements of the form $(x, (y, z))$, while $(X \otimes Y) \otimes Z$ contains elements of the form $((x, y), z)$.

- Similarly, this operation has $\mathbb{1} = \{\bullet\}$ as a unit, but it is again only a weak unit, meaning

$$\mathbb{1} \otimes X \neq X \neq X \otimes \mathbb{1}, \quad \text{but rather } \mathbb{1} \otimes X \cong X \cong X \otimes \mathbb{1}.$$

2C. **A word about conventions.** As we have seen in the example above, there are two operations for morphisms \circ and \otimes , but only one \otimes for objects. Recall, cf. Convention 1.1, that we already abbreviate $gf = g \circ f$, and we will do the same for objects:

Convention 2.1 We will write $XY = X \otimes Y$ for simplicity, and similarly we write X^k instead of $k \in \mathbb{N}$ factors of the form $X \otimes \dots \otimes X$

Convention 2.2 Although monoidal categories, functor etc. usually consists of a choice of extra data, we will for brevity often just write e.g. \mathbf{C} for a monoidal category. We also e.g. write " \mathbf{C} is a monoidal category" when the choice of monoidal structure is clear from the context.

Convention 2.3 There will be several places where we have two or more monoidal categories with potentially different structures. However, in order not to overload the notation we will write e.g. $\mathbb{1}$ for all of them instead of for example $\mathbb{1}_{\mathbf{C}}$.

2D. **Basics.** The definition of a monoidal category is a mouthful (but we will get rid most of the complication later in Theorem 2.32):

Definition 2.4 A monoidal category $(\mathbf{C}, \otimes, \mathbb{1}, \alpha, \lambda, \rho)$ consists of

- a category \mathbf{C} ;
- a bifunctor (cf. (2-2))

$$\otimes: \mathbf{C} \times \mathbf{C} \rightarrow \mathbf{C}, \quad \otimes((X, Y)) = XY, \quad \otimes((f, g)) = f \otimes g,$$

called monoidal product; $\otimes \rightsquigarrow$ multiplication in \mathbb{N}

- a unit (object) $\mathbb{1} \in \mathbf{C}$; $\rightsquigarrow 1 \in \mathbb{N}$
- a collection of natural isomorphisms

(2-3) $\alpha_{X,Y,Z}: X(YZ) \xrightarrow{\cong} (XY)Z,$

$a(bc) = (ab)c$

for all $X, Y, Z \in \mathbf{C}$, called associators;

- a collection of natural isomorphisms

(2-4) $\lambda_X: \mathbb{1}X \xrightarrow{\cong} X, \quad \rho_X: X\mathbb{1} \xrightarrow{\cong} X,$

$1a = a$
 $a1 = a$

for all $X \in \mathbf{C}$, called left and right unitors;

such that

(i) the pentagon equality holds, i.e. we have commuting diagrams

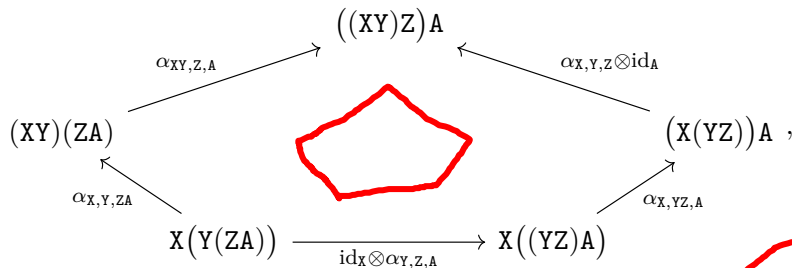

for all $X, Y, Z, A \in \mathbf{C}$.

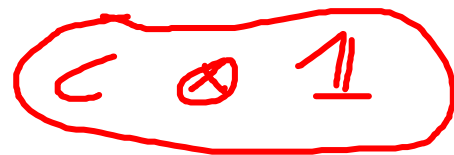

(ii) the triangle equality holds, i.e. we have commuting diagrams

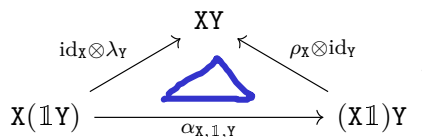

for all $X, Y \in \mathbf{C}$.

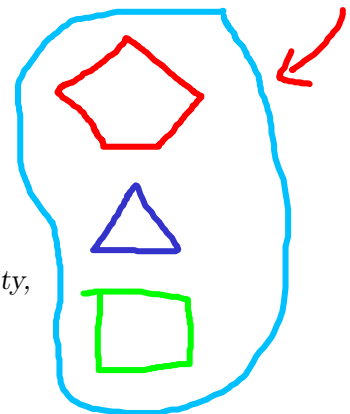

Remark 2.5 There is a hidden square equality, coming from naturality,

$$\begin{array}{ccc} X'(Y'Z') & \xrightarrow{\alpha_{X',Y',Z'}} & (X'Y')Z' \\ f \otimes (g \otimes h) \uparrow & \square & \uparrow (f \otimes g) \otimes h \\ X(YZ) & \xrightarrow{\alpha_{X,Y,Z}} & (XY)Z \end{array}$$

which holds for all for all $X, Y, Z \in \mathbf{C}$ and all $f, g, h \in \mathbf{C}$.

strict = as in \mathbb{N}

Definition 2.6 A monoidal category \mathbf{C} is called strict if all associators and unitors are identities, and non-strict otherwise.

all a trivial

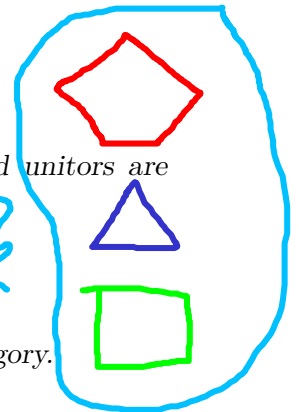

Example 2.7 Monoidal categories arise in the wild.

(a) As seen above, **Set** with $\otimes = \times$ and $\mathbb{1} = \{\bullet\}$ is a non-strict monoidal category.

(b) Similarly, \mathbf{Vec}_k or \mathbf{fdVec}_k with $\otimes = \otimes_k$ and $\mathbb{1} = k$ are non-strict monoidal categories.

(c) The skeletons of the three examples above, with the same monoidal structures, are strict monoidal categories.

Example 2.8 Monoidal structures on categories are far from being unique. For example, \mathbf{Vec}_k and \mathbf{fdVec}_k have another monoidal structure given by $\otimes = \oplus$ and $\mathbb{1} = \{0\}$, which is again non-strict. We will however always use the monoidal structures in [Example 2.7.\(b\)](#).

Example 2.9 Diagrammatic categories such as $\mathbf{1Cob}$, $\mathbf{1Tan}$ and $\mathbf{1State}$, cf. [Example 1.11](#), have (often) a monoidal structure given by \otimes being juxtaposition, e.g.

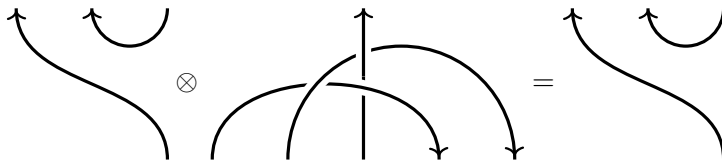

Horizontal

and $\mathbb{1}$ being the empty diagram. These monoidal structures are strict.

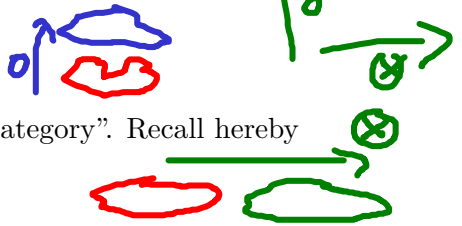

The following is in some sense the motivation for the name “monoidal category”. Recall hereby the Grothendieck classes $K_0(\mathbf{C})$ of \mathbf{C} , see [Definition 1.44](#).

Proposition 2.10 For any monoidal category \mathbf{C} its Grothendieck classes $K_0(\mathbf{C})$ form a monoid with multiplication and unit

$$[X][Y] = [XY], \quad \mathbb{1} = [1].$$



Proof. Directly from the definitions, e.g. the associator (2-3) and the unitors (2-4) descent to associativity and unitality on $K_0(\mathbf{C})$. □

cat. of \mathbb{N}

Example 2.11 Coming back to [Example 1.45](#), $K_0(\mathbf{fdVec}_k) \cong \mathbb{N}$ with $[k^n] \mapsto n$ is an isomorphism of monoids.

$$\otimes = \otimes_k$$

$$\dim(V \otimes W) = \dim V \dim W$$

[Example 2.9](#) gives important examples of strict monoidal categories, while crucial examples of non-strict monoidal categories are the monoidal incarnations of groups. These are very different from the ones we have, noting that every group is of course a monoid, seen in [Example 1.6.\(a\)](#):

Example 2.12 Let G be a group.

$\rightarrow G$ -graded VS

(a) The category $\mathbf{Vec}(G)$ is the category with $\text{Ob}(\mathbf{Vec}(G)) = G$, and whose morphisms are only identities. The monoidal product is $i \otimes j = ij$, with $i, j, ij \in G$. For example, if

+ with

$G = \mathbb{Z}/2\mathbb{Z} \times \mathbb{Z}/2\mathbb{Z}$, then we have

$(1,0) \otimes (0,1) = (1,1)$

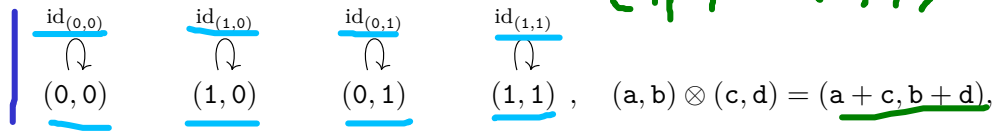

$$\text{Hom}_{\text{Vec}(G)}(i, j) = \begin{cases} \{\text{id}_i\} & \text{if } i = j, \\ \emptyset & \text{if } i \neq j. \end{cases}$$

Thus, as a category $\text{Vec}(G)$ is rather boring and the point is the monoidal structure, which is strict, by construction.

$K_0(\text{Vec}(G)) \cong G$

(b) We also have the \mathbb{k} linear version $\text{Vec}_{\mathbb{k}}(G)$ of $\text{Vec}(G)$. The only difference is that the endomorphisms are now given by scalars times the identities:

$$\text{Hom}_{\text{Vec}_{\mathbb{k}}(G)}(i, j) \cong \begin{cases} \mathbb{k} & \text{if } i = j, \\ 0 & \text{if } i \neq j. \end{cases}$$

The monoidal category $\text{Vec}_{\mathbb{k}}(G)$ is strict.

(c) Let $\omega \in Z^3(G, \mathbb{C}^*)$ be a 3 cocycle of G , see Remark 2.13. Then we can define a monoidal category $\text{Vec}_{\mathbb{C}}^{\omega}(G)$ exactly as above, but with associator and unitors

(2-5) $\alpha_{i,j,k} = \omega(i, j, k)\text{id}_{ijk}$ $\lambda_i = \omega(1, 1, i)^{-1}\text{id}_i$, $\rho_i = \omega(i, 1, 1)\text{id}_i$.

Explicitly, for $G = \mathbb{Z}/2\mathbb{Z}$ we have $H^3(G, \mathbb{C}^*) \cong \mathbb{Z}/2\mathbb{Z}$ and the non-trivial ω has $\omega(1, 1, 1) = -1$. Finally, note that $\text{Vec}_{\mathbb{C}}^1(G) = \text{Vec}_{\mathbb{C}}(G)$, but for a non-trivial $\omega \in H^3(G, \mathbb{C}^*)$ the monoidal category $\text{Vec}_{\mathbb{C}}^{\omega}(G)$ is non-strict and skeletal at the same time.

twists of \otimes

$\rightarrow K_0 = G$

Remark 2.13 For a group G , one can define a cohomology theory $H^*(G, \mathbb{C}^*)$, called **group cohomology**. As usual these are constructed from a certain cochain complex and $H^i(G, \mathbb{C}^*) = Z^i(G, \mathbb{C}^*)/B^i(G, \mathbb{C}^*)$, so i cocycles modulo i coboundaries. All we need to know about group cohomology are the 3 cocycles which are functions $\omega: G \times G \times G \rightarrow \mathbb{C}^*$ satisfying

$$\omega(j, k, l)\omega(i, jk, l)\omega(i, j, k) = \omega(ij, k, l)\omega(i, j, kl),$$

(2-6)

pictorially:

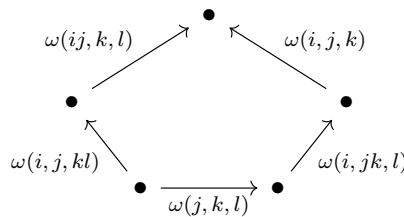

Comparing (2-6) and Definition 2.4 shows that scaling as in (2-5) satisfies the \triangle and \diamond equations.

Remark 2.14 Note that for $\text{Vec}(G)$ or $\text{Vec}_{\mathbb{k}}(G)$ we can also allow monoids M instead of groups G , or work over rings \mathbb{S} , but for $\text{Vec}_{\mathbb{S}}^{\omega}(M)$ one would need to be careful how to define it. For example, our cocycles take values in \mathbb{C}^* , but one could let them take values in e.g. \mathbb{k}^* .

A good question is whether we can "ignore" non-strict monoidal categories since working with associators and unitors is a bit messy. However, Example 2.12.(c) suggests that one can not simply go to the skeleton, although this works for monoidal categories such as $\text{fdVec}_{\mathbb{k}}$. We can only answer this question after we have a bit more technology at hand.

2E. Feynman diagrams for monoidal categories. Motivated by [Example 2.9](#), we get the following Feynman diagrammatics for strict monoidal categories. That is, given a strict monoidal category \mathbf{C} , we can depict \otimes as juxtaposition and the unit as an empty diagram, e.g.

(2-7) $\mathbb{1} \rightsquigarrow \emptyset, \quad XY \rightsquigarrow \begin{array}{c} X & Y \\ | & | \\ X & Y \end{array}, \quad g \otimes f \rightsquigarrow \begin{array}{c} A & Y \\ | & | \\ \boxed{g} & \boxed{f} \\ | & | \\ Z & X \end{array} \leftarrow \otimes \rightarrow$

Note the cute fact that we do not need to be careful with the relative heights in (2-7) since the interchange law (2-2) implies that

(2-8) $(\text{id}_A \otimes f) \circ (g \otimes \text{id}_X) \rightsquigarrow \begin{array}{c} A & Y \\ | & | \\ \boxed{g} & \boxed{f} \\ | & | \\ Z & X \end{array} = \begin{array}{c} A & Y \\ | & | \\ \boxed{g} & \boxed{f} \\ | & | \\ Z & X \end{array} \rightsquigarrow (g \otimes \text{id}_Y) \circ (\text{id}_Z \otimes f)$

We can also illustrate morphisms with many \otimes inputs nicely, e.g.

(2-9) $f: XYZ \rightarrow AB \rightsquigarrow \begin{array}{c} \overline{AB} \\ | \\ \boxed{f} \\ | \\ \overline{XYZ} \end{array}$

However, note that there are two drawbacks. First, diagrammatic calculus, by its very definition, is not suitable for non-strict monoidal categories. Second, although (2-8) looks promising, we do not have a 2 dimensional calculus yet as we are not allowed to change the upwards orientation of diagrams (recall [Convention 1.3](#)), e.g.

(2-10)

is not an allowed diagram.

Remark 2.15 One should stress here that (2-10) and the text around it is not a contradiction to [Example 2.9](#): in that example the diagrams actually are just abbreviations for upwards oriented Feynman diagrams, e.g.

$\curvearrowright \rightsquigarrow \begin{array}{c} \boxed{\text{cap}} \\ | & | \\ \bullet & \bullet^* \end{array}$

where \bullet and \bullet^* are the two generating objects of $\mathbf{1State}$, as we will see. (Note that the unit is omitted from diagrams, cf. (2-7).)

$\mathbb{1} = \emptyset$

Example 2.16 By our convention that $\mathbb{1}$ is diagrammatically presented by the empty diagram, it follows that every morphisms $f: \mathbb{1} \rightarrow \mathbb{1}$ is presented by a floating diagram:

$f: \mathbb{1} \rightarrow \mathbb{1} \rightsquigarrow \boxed{f}$

We discuss how to incorporate non-strict monoidal categories below; the flaw of having only upward oriented diagrams will be taken care of in [Section 4](#).

2F. **Coherence for monoids.** For starters, let us compare two definitions of a monoid M , with Def1 being the one that you will usually find in written texts:

correct →

(2-11)	Def1	a set M	multiplication	unit	$h(gf) = (hg)f$
	Def2	a set M	multiplication	unit	associativity

↙ had def. ↘ any()

where “associativity” means that all ways of using parentheses agree. Both definitions have their advantages: Def2 is arguably the correct definition, but Def1 is much more useful in practice and one only needs to check $h(fg) = (hg)f$ instead of infinitely many bracketings. So one would like to have the following, called coherence theorem for monoids, which is rarely stated:

Theorem 2.17 *The two definitions in (2-11) are equivalent.*

Proof. Clearly, Def2 implies Def1. To see that Def1 implies Def2, we argue diagrammatically. The condition $h(gf) = (hg)f$ can be pictured as

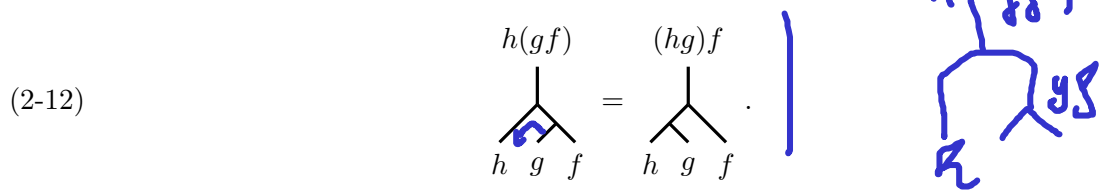

However, successively applying this equality gives

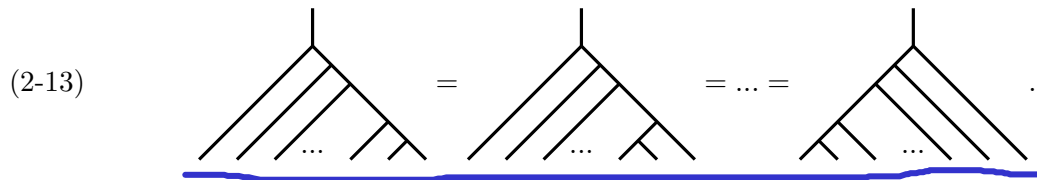

(Actually, these are not aligned, cf. (2-14).) Thus, all ways of putting parenthesis agree. \square

The above can also be stated differently. Let K_n be the 1 dimensional CW complex (a.k.a. graph) obtained by adding an edge to the disjoint union of the graphs in (2-13) (with n endpoints) for each application of (2-12), connecting the corresponding graphs. For example,

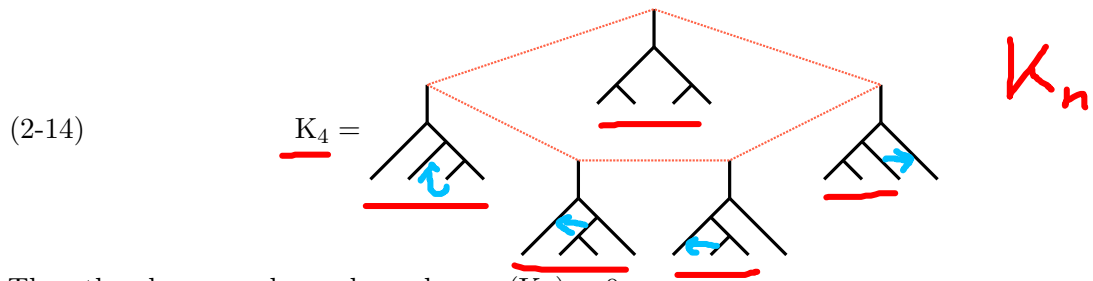

Then the above can be rephrased as $\pi_0(K_n) = 0 = 1$

2G. **Coherence for monoidal categories.** With respect to the discussion about coherence for monoids, in particular, (2-11), here is Def2 for monoidal categories with Def1 being [Definition 2.4](#).

Definition 2.18 A monoidal category $(\mathbf{C}, \otimes, \mathbb{1}, \alpha, \lambda, \rho)$ consists of

- a category \mathbf{C} ;

- a bifunctor (cf. (2-2))

$$\otimes: \mathbf{C} \times \mathbf{C} \rightarrow \mathbf{C}, \quad \otimes((X, Y)) = XY, \quad \otimes((f, g)) = f \otimes g,$$

called **monoidal product**;

- a **unit (object)** $\mathbb{1} \in \mathbf{C}$;

- a collection of natural isomorphisms

$$\alpha_{X,Y,Z}: X \otimes (Y \otimes Z) \xrightarrow{\cong} (X \otimes Y) \otimes Z,$$

for all $X, Y, Z \in \mathbf{C}$, called **associators**;

- a collection of natural isomorphisms

$$\lambda_X: \mathbb{1} \otimes X \xrightarrow{\cong} X, \quad \rho_X: X \otimes \mathbb{1} \xrightarrow{\cong} X,$$

for all $X \in \mathbf{C}$, called **left and right unitors**;

such that “every formal diagram” made up of associators and unitors commutes.

We will not define what “every formal diagram” means precisely as this gets a bit technical. Moreover, we will only sketch a proof of the coherence theorem for monoidal categories (also known as *Mac Lane’s coherence theorem*), which is up next, for the very same reason.

Theorem 2.19 *The two definitions Definition 2.4 and Definition 2.18 are equivalent.*

Proof. Let us sketch how this can be proven, following the exposition in [Ka93]. (A completely different proof is due to Mac Lane, see [Ma98, Section VII.2].) Let us focus on associators, the idea of the proof with unitors is exactly the same.

The proof works by constructing certain polytopes K_n , sometimes called Stasheff polytopes. These are 2 dimensional analogs of the graphs we have seen in the proof of Theorem 2.17, and constructed from the two relevant commuting diagrams, \square and \triangle equations. For example,

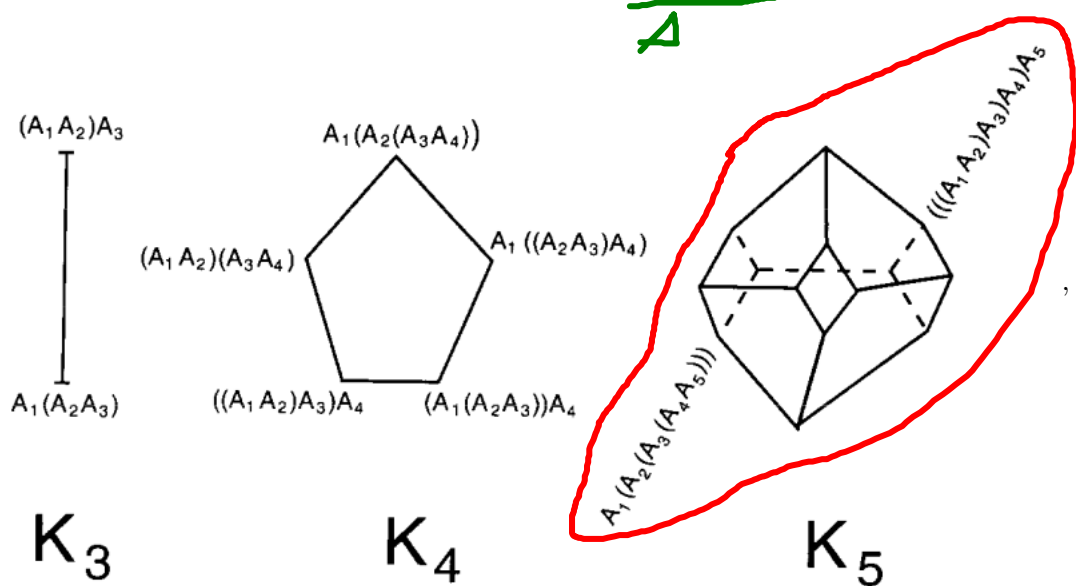

(the picture is taken from [Ka93]) so K_4 is just the \triangle equation. Then one needs to show that $\pi_1(K_n) = 1$. □

Note the analogy: In the 1 dimensional case (for monoids, categories *etc.*) one needs to assume that K_3 is “nice”, and all other polytopes will then also be “nice”. On the other hand, in the 2 dimensional case (for monoidal categories *etc.*) one needs to assume that K_4 is “nice”.

2H. **Monoidal functors, natural transformations and equivalences.** First things first:

Definition 2.20 A monoidal functor (F, ξ, ξ_1) with $F \in \mathbf{Hom}(\mathbf{C}, \mathbf{D})$ consists of

- a functor F ;
- a collection of natural isomorphisms

$$\xi_{X,Y}: F(X)F(Y) \xrightarrow{\cong} F(XY),$$

for all $X, Y \in \mathbf{C}$;

- a natural isomorphism

$$\xi_1: \mathbb{1} \xrightarrow{\cong} F(\mathbb{1});$$

such that

(i) the \hexagon equality holds, i.e. we have a commuting diagram

$$\begin{array}{ccccc}
 & & (F(X)F(Y))F(Z) & \xrightarrow{\xi_{X,Y} \otimes \text{id}_{F(Z)}} & F(XY)F(Z) & & \\
 & \nearrow^{\alpha_{F(X), F(Y), F(Z)}} & & & & \searrow^{\xi_{XY,Z}} & \\
 F(X)(F(Y)F(Z)) & & & & & & F((XY)Z) \\
 & \searrow_{\text{id}_{F(X)} \otimes \xi_{Y,Z}} & & & & \nearrow_{F(\alpha_{X,Y,Z})} & \\
 & & F(X)F(YZ) & \xrightarrow{\xi_{X,YZ}} & F(X(YZ)) & &
 \end{array}$$

for all $X, Y, Z \in \mathbf{C}$;

(ii) a left and a right \square equation holds, i.e. we have commuting diagrams

$$\begin{array}{ccc}
 \mathbb{1}F(X) & \xrightarrow{\xi_1 \otimes \text{id}_{F(X)}} & F(\mathbb{1})F(X) \\
 \lambda_{F(X)} \downarrow & & \downarrow \xi_{\mathbb{1},X} \\
 F(X) & \xleftarrow{F(\lambda_X)} & F(\mathbb{1}X)
 \end{array}
 \quad , \quad
 \begin{array}{ccc}
 F(X)\mathbb{1} & \xrightarrow{\text{id}_{F(X)} \otimes \xi_1} & F(X)F(\mathbb{1}) \\
 \rho_{F(X)} \downarrow & & \downarrow \xi_{X,\mathbb{1}} \\
 F(X) & \xleftarrow{F(\rho_X)} & F(X\mathbb{1})
 \end{array}$$

for all $X \in \mathbf{C}$.

Definition 2.21 A monoidal natural transformation $\alpha: F \Rightarrow G$ between monoidal functors $F, G \in \mathbf{Hom}(\mathbf{C}, \mathbf{D})$ is a natural transformation such that

(i) for all $X, Y \in \mathbf{C}$ there is a commuting diagram

$$\begin{array}{ccc}
 G(X)G(Y) & \xrightarrow{\xi_{X,Y}} & G(XY) \\
 \alpha_X \otimes \alpha_Y \uparrow & & \uparrow \alpha_{XY} \\
 F(X)F(Y) & \xrightarrow{\xi_{X,Y}} & F(XY)
 \end{array}$$

(ii) there is a commuting diagram

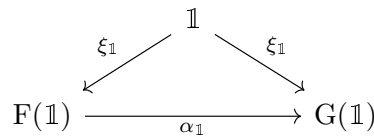

Lemma 2.22 We have the following.

(i) If F and G are monoidal functors, then so is GF .

(ii) If α and β are monoidal natural transformations, then so is $\beta\alpha$. □

Thus, since the identity functor has an evident structure of a monoidal functor:

Example 2.23 We get further examples of (plain) categories.

- (a) There is a category \mathbf{MCat} , the category of monoidal categories. Its objects are monoidal categories and its morphisms are monoidal functors.
- (b) There is a category $\mathbf{Hom}_{\otimes}(\mathbf{C}, \mathbf{D})$, the category of monoidal functors from \mathbf{C} to \mathbf{D} . Its objects are monoidal functors and its morphisms are monoidal natural transformations, with vertical composition (1-7).

Example 2.24 Given any category \mathbf{C} , the category $\mathbf{End}(\mathbf{C})$ of its endofunctors is a strict monoidal category:

- the composition \circ is vertical composition of natural transformations (1-7);
- the monoidal product on objects is $G \otimes F = GF$, i.e. composition of functors;
- the monoidal product on morphisms is $\beta \otimes \alpha = \beta\alpha$, i.e. horizontal composition of natural transformation (2-1).

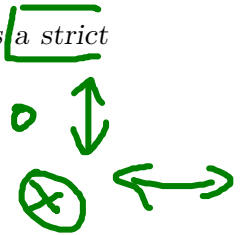

Definition 2.25 $\mathbf{C}, \mathbf{D} \in \mathbf{MCat}$ are called monoidally equivalent, denoted by $\mathbf{C} \simeq_{\otimes} \mathbf{D}$, if there exists an equivalence $F \in \mathbf{Hom}(\mathbf{C}, \mathbf{D})$ which is additionally a monoidal functor.

Example 2.26 Equivalent monoidal categories need not, but can be, monoidally equivalent:

- (a) Recall that $\mathbf{fdVec}_k \simeq \mathbf{Mat}_k$. Together with the choice of monoidal structures being the usual tensor products, this is an monoidal equivalence $\mathbf{fdVec}_k \simeq_{\otimes} \mathbf{Mat}_k$.
- (b) We have $\mathbf{Vec}_k(G) \simeq \mathbf{Vec}_k(G')$ are equivalent as categories if and only if $\#G = \#G'$. However, $\mathbf{Vec}_k(G) \simeq_{\otimes} \mathbf{Vec}_k(G')$ if and only if $G = G'$.
- (c) Similarly, $\mathbf{Vec}_k^{\omega}(G) \simeq \mathbf{Vec}_k^{\omega'}(G')$ holds always, i.e. regardless of the 3 cocycles. However, $\mathbf{Vec}_k^{\omega}(G)$ and $\mathbf{Vec}_k^{\omega'}(G)$ are rarely equivalent as monoidal categories. Explicitly, let ω be the non-trivial 3 cocycle of $G = \mathbb{Z}/2\mathbb{Z}$. Then $\mathbf{Vec}_{\mathbb{C}}(\mathbb{Z}/2\mathbb{Z}) \simeq \mathbf{Vec}_{\mathbb{C}}^{\omega}(\mathbb{Z}/2\mathbb{Z})$ but $\mathbf{Vec}_{\mathbb{C}}(\mathbb{Z}/2\mathbb{Z}) \not\simeq_{\otimes} \mathbf{Vec}_{\mathbb{C}}^{\omega}(\mathbb{Z}/2\mathbb{Z})$.

Remark 2.27 More general as in [Example 2.26.\(c\)](#), one can check that $\mathbf{Vec}_k^\omega(G) \not\cong_{\otimes} \mathbf{Vec}_k^{\omega'}(G)$ unless ω and ω' are cohomologically equivalent, see e.g. [\[EGNO15, Proposition 2.6.1\]](#). (The philosophy is that $H^3(G, k^*)$ “measures” how much choice there is to twist the associativity constrain.) One can further show that $\mathbf{Vec}_k^\omega(G)$ is only monoidally equivalent to a skeletal category if ω is cohomologically trivial.

Again, we have:

Lemma 2.28 Any functor $F \in \mathbf{Hom}_{\otimes}(\mathbf{C}, \mathbf{D})$ induces a monoid homomorphism

$$K_0(F): K_0(\mathbf{C}) \rightarrow K_0(\mathbf{D}), [X] \mapsto [F(X)].$$

Further, if F is an equivalence, then $K_0(F)$ is an isomorphism. □

We leave it to the reader to define monoidal analogs of notions which we have seen in [Section 1](#) (whenever appropriate), e.g. what a monoidal subcategory is. We only mention here that there are now three opposite categories (four, if one takes \mathbf{C} itself into account):

Definition 2.29 For any monoidal category \mathbf{C} , we define three additional monoidal categories

(2-15)		\mathbf{C}	\mathbf{C}^{op}	\mathbf{C}^{co}	\mathbf{C}^{coop}		⊗
	Reversed \circ ?	No	Yes	No	Yes		⊗
	Reversed \otimes ?	No	No	Yes	Yes		⊗

Using op is called taking the **opposite**, cf. [Definition 1.13](#), taking co is called taking the **coopposite**, and \mathbf{C}^{coop} is called the **biopposite** of \mathbf{C} .

2I. Strict vs. non-strict. Let us start the comparison of strict and non-strict monoidal categories with a crucial example of a strict monoidal category, very much in the spirit of [Example 2.24](#).

Definition 2.30 Given a monoidal category \mathbf{C} , define the category of right \mathbf{C} module endofunctors, denoted by $\mathbf{End}_{\mathbf{C}}(\mathbf{C})$, via:

- the objects are pairs (F, ρ) with $F \in \mathbf{End}(\mathbf{C})$ and natural isomorphisms $\rho_{X,Y}: F(X)Y \rightarrow F(XY)$ such that we have a commuting diagram

$$(2-16) \quad \begin{array}{ccccc} & & F((XY)Z) & & \\ & \nearrow^{F(\alpha_{X,Y,Z})} & & \nwarrow_{\rho_{XY,Z}} & \\ F(X(YZ)) & & & & F(XY)Z \\ & \nwarrow_{\rho_{X,YZ}} & & \nearrow_{\rho_{X,Y} \otimes \text{id}_Z} & \\ & & F(X)(YZ) & \xrightarrow{\alpha_{F(X),Y,Z}} & (F(X)Y)Z \end{array}$$

for all $X, Y, Z \in \mathbf{C}$;

- the morphisms $\alpha: (F, \rho) \Rightarrow (G, \rho')$ are natural transformations $\alpha: F \Rightarrow G$ such that we have a commuting diagram

$$(2-17) \quad \begin{array}{ccc} G(\mathbf{X})\mathbf{Y} & \xrightarrow{\rho'_{\mathbf{X},\mathbf{Y}}} & G(\mathbf{X}\mathbf{Y}) \\ \alpha_{\mathbf{X}} \otimes \text{id}_{\mathbf{Y}} \uparrow & & \uparrow \alpha_{\mathbf{X}\mathbf{Y}} \\ F(\mathbf{X})\mathbf{Y} & \xrightarrow{\rho_{\mathbf{X},\mathbf{Y}}} & F(\mathbf{X}\mathbf{Y}) \end{array}$$

for all $\mathbf{X}, \mathbf{Y} \in \mathbf{C}$;

- the composition \circ is vertical composition of natural transformations.

Lemma 2.31 For $\mathbf{End}_{\mathbf{C}}(\mathbf{C})$ as in Definition 2.30 the rules

- \otimes on objects is $(G, \rho')(F, \rho) = (GF, \rho'')$, where

$$\rho''_{\mathbf{X},\mathbf{Y}} = (GF(\mathbf{X}))\mathbf{Y} \xrightarrow{\rho'_{F(\mathbf{X}),\mathbf{Y}}} G(F(\mathbf{X})\mathbf{Y}) \xrightarrow{G(\rho_{\mathbf{X},\mathbf{Y}})} GF(\mathbf{X}\mathbf{Y});$$

- \otimes on morphisms is horizontal composition of natural transformations;

define the structure of a strict monoidal category on $\mathbf{End}_{\mathbf{C}}(\mathbf{C})$ with $\mathbb{1} = \text{Id}_{\mathbf{C}}$.

proto. ex. of a strict cat.

Proof. All appearing structures use compositions, either of maps, functors or of natural transformations, which are associative by definition. Thus, the only calculation one needs to check is that $\beta\alpha$ satisfies (2-17) if α and β do. This is straightforward. \square

Comparing the definitions of a monoidal category (in particular, the \triangle and the \diamond equations) and of a strict monoidal category, the following seems to be surprising.

Theorem 2.32 For any monoidal category \mathbf{C} there exists a strict monoidal category \mathbf{C}^{st} which is monoidally equivalent to \mathbf{C} , i.e. $\mathbf{C} \simeq_{\otimes} \mathbf{C}^{st}$.

The statement of Theorem 2.32 is called strictification, and it allows us to very often “ignore” that we have to worry about associators and unitors. For example, we get diagrammatics for any monoidal category by passing to \mathbf{C}^{st} .

Proof. The idea is as follows. As a matter of fact, every monoid M is isomorphic to the monoid $\text{End}_M(M)$ consisting of maps from M to itself commuting with the right multiplication of M ; the isomorphism is given by left multiplication. We will prove the theorem by copying this fact, i.e. we will show that \mathbf{C}^{st} can be chosen to be $\mathbf{End}_{\mathbf{C}}(\mathbf{C})$.

By Lemma 2.31 we have a strict monoidal category $\mathbf{End}_{\mathbf{C}}(\mathbf{C})$, which has a left action functor

$$L: \mathbf{C} \rightarrow \mathbf{End}_{\mathbf{C}}(\mathbf{C}), \quad L(\mathbf{X}) = (\mathbf{X} \otimes -, \alpha_{\mathbf{X},-, -}^{-1}), L(f) = f \otimes -.$$

Note that (2-16) for L is the \diamond equation.

The functor L is an equivalence of categories, which we verify using Proposition 1.52.

- The functor L is dense since any (F, ρ) is isomorphic to $L(F(\mathbb{1}))$.

- The functor L is faithful, since $L(f) = L(g)$ implies $f \otimes \text{id}_{\mathbb{1}} = g \otimes \text{id}_{\mathbb{1}}$, which in turn gives $f = g$, by naturality of the unitor ρ . That is, commutativity of

$$\begin{array}{ccc} X\mathbb{1} & \xrightarrow{\rho_X} & X \\ f \otimes \text{id}_{\mathbb{1}} \downarrow & & \downarrow f \otimes \text{id}_{\mathbb{1}} \\ Y\mathbb{1} & \xrightarrow{\rho_Y} & Y \end{array}, \quad \begin{array}{ccc} X\mathbb{1} & \xrightarrow{\rho_X} & X \\ g \otimes \text{id}_{\mathbb{1}} \downarrow & & \downarrow g \otimes \text{id}_{\mathbb{1}} \\ Y\mathbb{1} & \xrightarrow{\rho_Y} & Y \end{array}$$

with bottom and top being isomorphisms and $f \otimes \text{id}_{\mathbb{1}} = g \otimes \text{id}_{\mathbb{1}}$ implies $f = g$.

- Given a morphism $\alpha \in \mathbf{End}_{\mathcal{C}}(\mathcal{C})$, define a morphism

$$f = X \xrightarrow{\rho_X^{-1}} X\mathbb{1} \xrightarrow{\alpha_{\mathbb{1}}} Y\mathbb{1} \xrightarrow{\rho_Y} Y.$$

Direct verification shows that $L(f) = \alpha$, thus L is full.

Finally, we define the structure of a monoidal functor on L via defining

- $\xi_{X,Y}: (X \otimes (Y \otimes -), \text{id}_X \otimes \alpha_{Y,-,-}^{-1}, \alpha_{X,Y,-}^{-1}) \xrightarrow{\cong} ((X \otimes Y) \otimes -, \alpha_{XY,-,-}^{-1})$ to be the associator $\alpha_{X,Y,-}$;
- $\xi_{\mathbb{1}}: (\text{Id}_{\mathcal{C}}, \text{id}) \xrightarrow{\cong} (\mathbb{1} \otimes -, \alpha_{\mathbb{1},-,-}^{-1})$ to be given by the inverse of the left unitor λ .

One verifies that this satisfies the axioms in [Definition 2.20](#). □

Remark 2.33 *Alternatively, [Theorem 2.32](#) can be proven using [Theorem 2.19](#), see e.g. [\[Ma98, Section XI.3\]](#).*

2J. More graphical calculus. Recall the rules for diagrammatics of strict monoidal categories, i.e. (2-7) and (2-9). The formal rule of manipulation of these diagrams is:

(2-18) “Two diagrams are equivalent if they are related by scaling or by a planar isotopy keeping the upwards orientation.”

Theorem 2.34 *The graphical calculus is consistent, i.e. two morphisms are equal if and only if their diagrams are related by (2-18).*

Proof. This basically boils down to (2-8). □

Example 2.35 *Note that the condition of keeping the upwards orientation is a bit strange. In fact, it is probably not needed and can be dropped. The condition of only allowing planar isotopies is however crucial and e.g.*

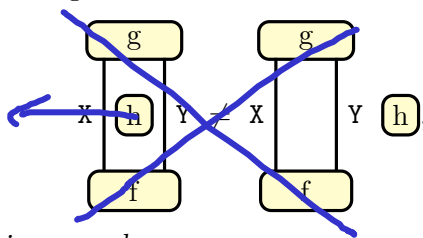

present different morphisms in general.

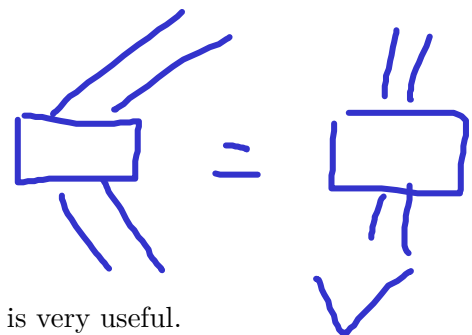

Let us finish by showing the first hints why the diagrammatic calculus is very useful.

Proposition 2.36 *For $\mathcal{C} \in \mathbf{MCat}$ the space $\mathbf{End}_{\mathcal{C}}(\mathbb{1})$ is a commutative monoid.*

Proof. The diagrammatic equation

$$\boxed{gf} = \begin{array}{c} \boxed{g} \\ \downarrow \\ \boxed{f} \end{array} = \begin{array}{c} \boxed{g} \\ \downarrow \\ \boxed{f} \end{array} = \begin{array}{c} \boxed{f} \\ \downarrow \\ \boxed{g} \end{array} = \boxed{fg}$$

1
□
1

proves commutativity. □

Proposition 2.37 For $\mathbf{C} \in \mathbf{MCat}$ and for any $X, Y \in \mathbf{C}$, we have commuting actions

$$\text{End}_{\mathbf{C}}(\mathbb{1}) \circlearrowleft \text{Hom}_{\mathbf{C}}(X, Y) \circlearrowright \text{End}_{\mathbf{C}}(\mathbb{1}),$$

given by

$$\boxed{f} \cdot \begin{array}{c} Y \\ | \\ \boxed{h} \\ | \\ X \end{array} := \begin{array}{c} Y \\ | \\ \boxed{f} \boxed{h} \\ | \\ X \end{array}, \quad \begin{array}{c} Y \\ | \\ \boxed{h} \\ | \\ X \end{array} \cdot \boxed{g} := \begin{array}{c} Y \\ | \\ \boxed{h} \\ | \\ X \end{array} \boxed{g}.$$

Thus, $\text{Hom}_{\mathbf{C}}(X, Y)$ is an $\text{End}_{\mathbf{C}}(\mathbb{1})$ -bimodule.

Proof. Associativity and unitality of the left action reads as

$$\boxed{g} \cdot \left(\boxed{f} \cdot \begin{array}{c} Y \\ | \\ \boxed{h} \\ | \\ X \end{array} \right) = \boxed{g} \boxed{f} \begin{array}{c} Y \\ | \\ \boxed{h} \\ | \\ X \end{array} = \boxed{gf} \cdot \begin{array}{c} Y \\ | \\ \boxed{h} \\ | \\ X \end{array}, \quad \emptyset \cdot \begin{array}{c} Y \\ | \\ \boxed{h} \\ | \\ X \end{array} = \begin{array}{c} Y \\ | \\ \boxed{h} \\ | \\ X \end{array}.$$

By reflecting the diagrams right to left, the same follows for the right action. Finally,

$$\begin{array}{c} \uparrow \\ \boxed{f} \end{array} \begin{array}{c} Y \\ | \\ \boxed{h} \\ | \\ X \end{array} \begin{array}{c} \downarrow \\ \boxed{g} \end{array} = \begin{array}{c} Y \\ | \\ \boxed{f} \boxed{h} \\ | \\ X \end{array} \begin{array}{c} \downarrow \\ \boxed{g} \end{array} = \begin{array}{c} Y \\ | \\ \boxed{h} \\ | \\ X \end{array} \begin{array}{c} \downarrow \\ \boxed{f} \end{array} \begin{array}{c} \uparrow \\ \boxed{g} \end{array}$$

shows that the two actions commute. □

Proposition 2.38 The bimodule structure on $\text{Hom}_{\mathbf{C}}(X, Y)$ from Proposition 2.37 is compatible with \circ and \otimes .

Proof. This is Exercise 2.43. □

2K. Exercises.

Exercise 2.39 Explain explicitly what the four opposites from (2-15) are for the monoidal categories $\mathbf{1Cob}$, $\mathbf{1Tan}$ and $\mathbf{1State}$.

Exercise 2.40 Verify that $\mathbf{End}(\mathbf{C})$ is a strict monoidal category, cf. Example 2.24.

Exercise 2.41 Show that $\mathbf{Vec}_{\mathbb{k}}(\mathbb{Z}/2\mathbb{Z}) \not\cong_{\otimes} \mathbf{Vec}_{\mathbb{k}}^{\omega}(\mathbb{Z}/2\mathbb{Z})$ if ω is the non-trivial 3 cocycle. What happens for $\mathbb{k} = \mathbb{F}_2$ compared to $\mathbb{k} = \mathbb{C}$?

Exercise 2.42 Verify that $\mathbf{End}_{\mathbf{C}}(\mathbf{C})$ is a category, cf. Definition 2.30.

Exercise 2.43 Prove Proposition 2.38 diagrammatically. Hereby, compatibility means

$$f \cdot (jh) = (f \cdot j)h = j(f \cdot h), \quad f \cdot (h \otimes j) = (f \cdot h) \otimes j,$$

and vice versa for the right action.

3. MONOIDAL CATEGORIES II – MORE GRAPHICAL CALCULUS

The next question we will address, which will in particular give a rigorous, non-topological, construction of 1Cob, 1Tan and 1State, is:

How to construct monoidal categories or algebraic objects using diagrammatic calculus?

3A. A word about conventions. This section is all about the algebra of diagrams.

Convention 3.1 Note the terminology, which we will use several times: “free as an ABC” means that no relation except the ones forced by “being an ABC” hold, and we will write “generated by XYZ” for short instead of “generated as an ABC by XYZ”. Moreover, we sometimes do not define what “generated (as an ABC) by XYZ” means precisely as it will be clear from the context, see e.g. [Example 3.5.\(b\)](#) for a non-defined phrase.

Convention 3.2 We usually simplify notation involving generators and relations as long as no confusion can arise. For example, all generators and relations will be elements of sets, but we omit the set brackets to make the notation less cumbersome.

Convention 3.3 All diagrammatics in this section are defined by generators and relations, in particular, not topologically. However, to simplify illustrations we draw diagrams sometimes in a topological fashion, and say some relations are mirrors of one another, e.g. the relations in (3-2) without mirrors are

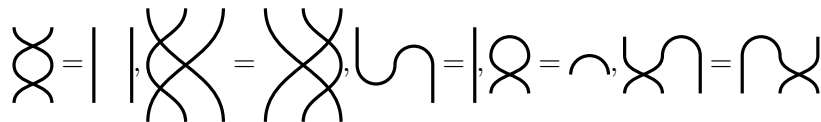

Convention 3.4 If certain notions only make sense under specific assumptions, then we tend to not to repeat these assumptions, e.g. we write “algebras” rather than “algebras in monoidal categories”.

Koreis = M
↑ ⊗ ↗

3B. Generator-relation presentation for monoids. Recall the following constructions.

Given a set S, we obtain the free monoid generated (as a monoid) by S, denoted by $\langle S \mid \emptyset \rangle$, defined by:

- elements are finite words $s_{i_r} \dots s_{i_1}$, where $s_{i_j} \in S$ are the *letters*, and $r \in \mathbb{N}$;
- composition is concatenation of words;
- the unit is the empty word \emptyset ;
- associativity is the only relation among words.

$S = \{a, b\}$

$aabba babb$

The elements of S are called *generators* (of $\langle S \mid \emptyset \rangle$).

$w \cdot w' = ww'$
 $ab \cdot b = abb$

Similarly, the free group generated (as a group) by S, also denoted by $\langle S \mid \emptyset \rangle$, is defined *verbatim*, but having additional formal letters s_i^{-1} satisfying $s_i s_i^{-1} = 1 = s_i^{-1} s_i$.

Example 3.5 We stress that being free depends on the adjectives:

- (a) The free monoid generated by $S = \{\bullet\}$ is isomorphic to \mathbb{N} , while the free group generated by $S = \{\bullet\}$ is isomorphic to \mathbb{Z} ; ... = $\rightarrow 4$
 $2+3=5$
- (b) The free commutative monoid generated by $S = \{\bullet, *\}$ is isomorphic to \mathbb{N}^2 while the free monoid generated by $S = \{\bullet, *\}$ is not isomorphic to \mathbb{N}^2 . $\bullet \rightarrow (1, 0)$
 $* \rightarrow (0, 1)$
 $baa^{-1} = b$

Moreover, fix two sets S and R, where

$$R \subset \langle S \mid \emptyset \rangle \times \langle S \mid \emptyset \rangle.$$

$$aba = bab$$

The elements of R will be written as $r = r'$ for $r, r' \in \langle S \mid \emptyset \rangle$ and we call them *relations*. We obtain the monoid generated by S with relations R, denoted by $\langle S \mid R \rangle$ as the quotient

$$\langle S \mid R \rangle = \langle S \mid \emptyset \rangle / R,$$

meaning that two words in $\langle S \mid \emptyset \rangle$ are equal in $\langle S \mid R \rangle$ if and only if they can be obtained from one another by using a finite number of relations from R. Said otherwise, taking the quotient by the congruence generated by R.

If $M \cong \langle S \mid R \rangle$, then we say $S \mid R$ give a generator-relation presentation of M.

Example 3.6 Again, this depends on the adjectives:

- (a) For $S = \{\bullet\}$ and $R = \{\bullet\bullet = 1\}$ we get $\langle S \mid R \rangle \cong \mathbb{Z}/2\mathbb{Z}$, regardless of whether we want to view this as being generated as a monoid or as a group.
- (b) The symmetry group of the triangle, i.e. the dihedral group $I_2(3)$ of order 6, has the generator-relation presentations

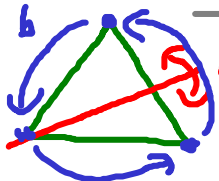

$$I_2(3) \cong \langle a, b \mid a^2 = 1, b^3 = 1, aba = b^{-1} \rangle \cong \langle s, t \mid s^2 = 1, t^2 = 1, sts = tst \rangle,$$

where the middle expression is read to be as a group, while the right expression can be either as a monoid or a group.

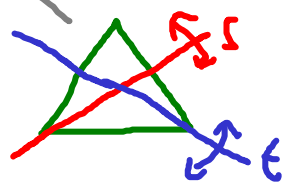

The set-theoretical issues of the following lemma are as usual ignored.

Lemma 3.7 Every monoid has a generator-relation presentation.

Proof. Take $S = M$ and let R be given by all equations coming from multiplication in M. □

The presentation obtained via Lemma 3.7 is, of course, useless. In general it is hard question whether one can find a good generator-relation presentation for a given monoid, group etc. But it is a good question, since we have the following evident, but useful, fact:

Lemma 3.8 To define a morphism $f: \langle S \mid R \rangle \rightarrow M$ to any monoid M it suffices to

- specify $f(s)$ for $s \in S$;
- check that $f(r) = f(r')$ for $r = r' \in R$.

↑ useful

□

Example 3.9 In the free case we have $R = \emptyset$. Thus, every choice $f(s)$ for $s \in S$ defines a morphism, regardless of M .

3C. **Generator-relation presentation for monoidal categories.** We generalize the above:

Definition 3.10 A set T is called a set of **morphism generators** if it consists of triples (f, X, Y) . Such a set is compatible with a set S if

$$X, Y \in \langle S \mid \emptyset \rangle,$$

$$X \circ Y \circ Z = XYZ$$

in which case we call S a set of **object generators**.

Of course we think of elements of S and T as being objects and morphisms $f: X \rightarrow Y$, respectively.

Definition 3.11 We define words as follows.

- An **object word** (in S) is a word in $\langle S \mid \emptyset \rangle$, which can be concatenated as for monoids.
- A **morphism word** (in T) is defined recursively as follows. A morphism word of length 1 is either an element of T or of the form (id_X, X, X) for $X \in \langle S \mid \emptyset \rangle$. Suppose all morphism words of length $n \geq 1$ are already defined. A morphism word of length $n + 1$ is either of the form



- (gf, X, Z) (\circ concatenation),



- $(f \otimes h, XA, YB)$ (\otimes concatenation),

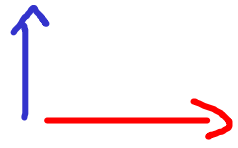

where (f, X, Y) , (g, Y, Z) and (h, A, B) are morphism words of length n . The two ways to create new words are also the two possible concatenations of morphism words.

We denote the collections of objects and morphism words by $\langle S \mid \emptyset \rangle$ and $\langle T \mid \emptyset \rangle_{\circ, \otimes}$.

Definition 3.12 Given sets S and T of object and morphism generators, we define the **free strict monoidal category (monoidally generated) by S and T** , denoted by $\langle S, T \mid \emptyset \rangle$, as:

- the objects are $\langle S \mid \emptyset \rangle$; *1-dim words*
- the morphisms are $\langle T \mid \emptyset \rangle_{\circ, \otimes}$; *2-dim words*
- composition is \circ concatenation of morphism words; \longleftrightarrow
- the monoidal product is \otimes concatenation of object respectively morphism words;
- the unit is $\mathbb{1} = 1 \in \langle S \mid \emptyset \rangle$;
- the relations among object words are

$$\underline{X(YZ) = (XY)Z, \quad \underline{\mathbb{1}X = X = X\mathbb{1}},$$

where $X, Y, Z \in \langle S \mid \emptyset \rangle$;

- the relations among morphism words are

$$\underline{h(gf) = (hg)f, \quad \underline{\text{id}_Y f = f = \text{id}_X},$$

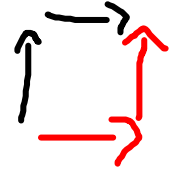

$$f \otimes (g \otimes h) = (f \otimes g) \otimes h, \quad \text{id}_1 \otimes f = f = f \otimes \text{id}_1,$$

$$\text{id}_X \otimes \text{id}_Y = \text{id}_{XY}, \quad \underline{(gf) \otimes (kh) = (g \otimes k)(f \otimes h)},$$

where $X, Y \in \langle S \mid \emptyset \rangle$ and $f, g, h \in \langle T \mid \emptyset \rangle_{\circ, \otimes}$

Remark 3.13 The last two bullet points in Definition 3.12 should be read as follows. The only relations among object words are those ensuring that $\langle S \mid \emptyset \rangle$ is the free monoid generated by S . The only relations among morphism words are those ensuring that \circ is a composition in a category and \otimes is a bifunctor, i.e. (2-2), for a strict monoidal category.

Example 3.14 We have $\langle \underline{\{ \bullet \}}, \emptyset \mid \emptyset \rangle \simeq_{\otimes} \text{Vec}(\mathbb{N})$, the latter being the evident adaption of Example 2.12.(a) to the monoid \mathbb{N} .

As before we can choose

$$R \subset \langle T \mid \emptyset \rangle_{\circ, \otimes} \times \langle T \mid \emptyset \rangle_{\circ, \otimes}.$$

R lives in morphisms

The elements of R will be written as $r = r'$ for $r, r' \in \langle T \mid \emptyset \rangle_{\circ, \otimes}$ and we call them relations.

Definition 3.15 We define the strict monoidal category generated by S and T with relations R , denoted by $\langle S, T \mid R \rangle$, as the quotient

$$\underline{\langle S, T \mid R \rangle} = \underline{\langle S, T \mid \emptyset \rangle} / R,$$

meaning that two morphism words in $\langle S, T \mid \emptyset \rangle$ are equal in $\langle S, T \mid R \rangle$ if and only if they can be obtained from one another by using a finite number of relations from R .

Definition 3.16 If $C \simeq_{\otimes} \underline{\langle S, T \mid R \rangle}$, then we say $S, T \mid R$ give a generator-relation presentation of C .

The following two lemmas can be proven *verbatim* as for monoids, using beforehand Theorem 2.32 for Lemma 3.17 if the monoidal category of interest is not strict.

Lemma 3.17 Every monoidal category has a generator-relation presentation. □

Lemma 3.18 To define a monoidal functor $F: \langle S, T \mid R \rangle \rightarrow C$ to any strict monoidal category C it suffices to

- specify $F(X)$ for $X \in S$;
- specify $F(f)$ for $f \in T$;
- check that $F(r) = F(r')$ for $r = r' \in R$. □

Example 3.19 In the free case again any choice works, regardless of C .

3D. Examples for generator-relation presentations. Recall that we write $X^k = X \dots X$.

Remark 3.20 We stress that all diagrams we will use below are not topological objects, but rather formal symbols. However, as we will see, one should think of them as being topological objects, see also *Convention 3.3*.

$$|X| |1| \otimes |X| = |X| |1| |X|$$

Example 3.21 The category of symmetric groups \mathbf{Sym} can be defined as follows. We let $\mathbf{Sym} = \langle \mathbf{S}, \mathbf{T} \mid \mathbf{R} \rangle$ with

(3-1) $\mathbf{S} : \bullet, \mathbf{T} : \text{X} : \bullet^2 \rightarrow \bullet^2, \mathbf{R} : \text{X} = |, \text{X} = \text{X}, \text{X} = \text{X}.$

Remark 3.22 There are extra relations which are implicit, e.g.

$$\text{X} \text{X} = \text{X} \text{X}$$

We do not need to add this relation to (3-1) since it follows from the interchange law, cf. (2-8)

It is a (non-trivial) fact that $\mathbf{Sym} \simeq_{\otimes} \mathbf{Sym}^{top} \subset \mathbf{1Cob}$, see *Example 1.50*, and the above can be seen as a purely algebraic construction of the (topologically defined) category \mathbf{Sym}^{top} .

Example 3.23 The (generic) Rumer–Teller–Weyl category \mathbf{TL} (also known as the generic Temperley–Lieb category, hence the notation) is defined as follows. We let

$\mathbf{S} : \bullet, \mathbf{T} : \text{X} : \mathbb{1} \rightarrow \bullet^2, \cup : \bullet^2 \rightarrow \mathbb{1}, \mathbf{R} : \text{X} = | = \cup.$

Again, its non-trivial, but visually clear, that TL is a monoidal subcategory of 1Cob.

Example 3.24 The (generic) Brauer category \mathbf{Br} is defined as follows. We let

(3-2) $\mathbf{S} : \bullet, \mathbf{T} : \text{X} : \bullet^2 \rightarrow \bullet^2, \cap : \mathbb{1} \rightarrow \bullet^2, \cup : \bullet^2 \rightarrow \mathbb{1}$

$\mathbf{R} : \left\{ \begin{array}{l} \text{X} = |, \text{X} = \text{X}, \cup = | = \cap \\ \cap = \cup, \cup = \cup, \text{X} = \text{X}, \text{X} = \text{X} \end{array} \right.$

Example 3.25 With *Lemma 3.18* it is easy to define monoidal functors

$$\begin{aligned} I_{\mathbf{Sym}}^{\mathbf{Br}} : \mathbf{Sym} &\rightarrow \mathbf{Br}, \bullet \mapsto \bullet, \text{X} \mapsto \text{X}, \\ I_{\mathbf{TL}}^{\mathbf{Br}} : \mathbf{TL} &\rightarrow \mathbf{Br}, \bullet \mapsto \bullet, \cap \mapsto \cap, \cup \mapsto \cup. \end{aligned}$$

These are dense by construction, and with a bit more work one can show that they are faithful. Thus, \mathbf{Sym} and \mathbf{TL} are (non-full) monoidal subcategories of \mathbf{Br} .

The punchline is that $\mathbf{Br} \simeq_{\otimes} \mathbf{1Cob}$. Let us state this as a theorem, whose proof we will sketch, highlighting what is easy and what is non-trivial about this statement.

Theorem 3.26 There exists a monoidal functor

(3-3) $\mathbf{R} : \mathbf{Br} \rightarrow \mathbf{1Cob}, \bullet \mapsto \bullet, \text{X} \mapsto \text{X}, \cap \mapsto \cap, \cup \mapsto \cup.$

The functor R is dense and fully faithful, thus, $\mathbf{Br} \simeq_{\otimes} \mathbf{1Cob}$.

Crucial: the left diagrams in (3-3) are just algebraic symbols, while the right diagrams are just placeholder symbols for topological objects.

Proof. There are several things to check, namely:

- (a) The functor R is a well-defined monoidal functor. Using Lemma 3.18, this is just the observation that the Brauer relations (3-2) hold in $\mathbf{1Cob}$, which is easy.
- (b) That R is dense is clear.
- (c) That R is full is not hard: Every 1 dimensional cobordism in $\mathbf{1Cob}$ has locally a Morse point, or not. But Morse points in this situation are just caps or cups. Moreover, taking the immersion (into the plane) of the cobordism into account, locally a 1 dimensional cobordism in $\mathbf{1Cob}$ is of the form

generically: \downarrow , immersion: \times , Morse: \cap, \cup .

In particular, we have a Morse positioning of such cobordisms. Here is an example:

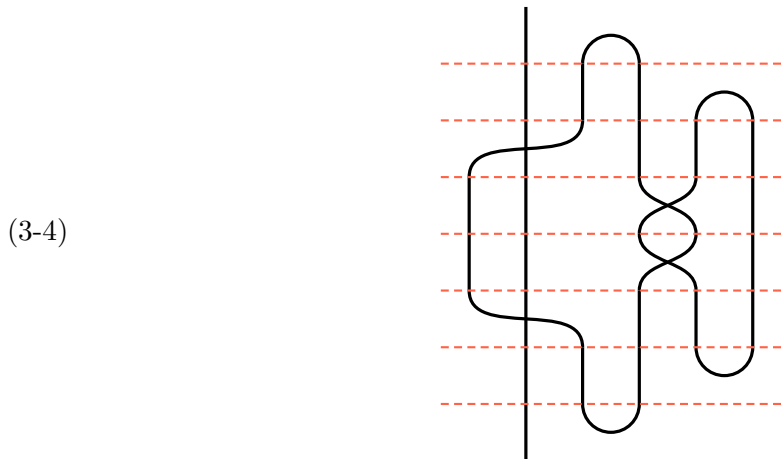

where the horizontal and dashed lines indicate height levels. Said otherwise, crossings, caps and cups generate $\mathbf{1Cob}$, so R is full as all generators of $\mathbf{1Cob}$ appear in its image. (Note that already here one would need to be precise what one means by a “1 dimensional cobordism”. But this is not the hard part.)

- (d) The proof that R is faithful is hard and painful, because one needs to show that the topologically defined $\mathbf{1Cob}$ has the Brauer relations (3-2) as generating relations. (See also Exercise 3.45.) □

Remark 3.27 By the same reason as in (d) in the proof of Theorem 3.26, it is hard to write down any functor $\mathbf{1Cob} \rightarrow \mathbf{Br}$. That is, the inverse of R is of course

$$R^{-1}: \mathbf{1Cob} \rightarrow \mathbf{Br}, \bullet \mapsto \bullet, \times \mapsto \times, \cap \mapsto \cap, \cup \mapsto \cup.$$

But showing that this is well-defined boils down to (d).

easier

There are several variations of the Brauer category \mathbf{Br} , e.g. with orientations, which we will revisit later. For now we are brief:

Example 3.28 The (generic) quantum Brauer category qBr, the (generic) oriented Brauer category oBr and the (generic) oriented quantum Brauer category oqBr are defined verbatim as the Brauer category, with a few differences:

- the adjective “oriented” means that one has two object generators \bullet and \bullet^* and one has oriented caps and cups generators, i.e.

(3-5) $\cup: \bullet\bullet^* \rightarrow \mathbb{1}, \quad \cap: (\bullet^*)\bullet \rightarrow \mathbb{1}, \quad \smile: \mathbb{1} \rightarrow \bullet\bullet^*, \quad \frown: \mathbb{1} \rightarrow (\bullet^*)\bullet;$

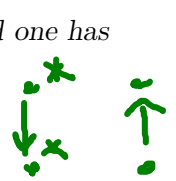

- the adjective “quantum” means that one distinguishes over- and undercrossings, i.e.

(3-6) overcrossing: \curvearrowright , undercrossing: \curvearrowleft .



All of these have analogs of [Theorem 3.26](#), e.g. qBr \simeq_{\otimes} 1Tan.

Example 3.29 We also have qSym, the category of braids, being the analog of Sym with crossing as in (3-6), but as a subcategory of qBr. Similarly, we also have oTL, the oriented version of TL, with oriented diagrams as in (3-5).



3E. Algebras in monoidal categories. Next, we aim to generalize the notion of an algebra.

Definition 3.30 An algebra A = (A, m, i) in a monoidal category C consists of

- an object A \in C;
- a multiplication, i.e. a morphism m: AA \rightarrow A;
- a unit, i.e. a morphism i: 1 \rightarrow A;

such that

(i) we have a commuting diagram

(3-7)
$$\begin{array}{ccc} A(AA) & \xrightarrow{\alpha_{A,A,A}} & (AA)A \\ \text{id}_A \otimes m \downarrow & & \downarrow m \otimes \text{id}_A \\ AA & \xrightarrow{m} & A \xleftarrow{m} & AA \end{array}$$

asso

$abc = (abc)$

non-strict

(ii) we have commuting diagrams

$$\begin{array}{ccc} & A & \\ \lambda_A \nearrow & & \nwarrow m \\ \mathbb{1}A & \xrightarrow{i \otimes \text{id}_A} & AA \end{array}, \quad \begin{array}{ccc} & A & \\ \rho_A \nearrow & & \nwarrow m \\ A\mathbb{1} & \xrightarrow{\text{id}_A \otimes i} & AA \end{array}$$

unit

$1a = a$
 $a1 = a$

A coalgebra C = (C, d, e) in a monoidal category C is, by definition, an algebra in C^{op}.

Of course, the three commuting diagrams in [Definition 3.30](#) are associativity (recall that (3-7) implies honest associativity) and unitality, but in the context of (not necessary strict) monoidal categories. Similarly for coalgebras. The Feynman diagrams can be simplified:

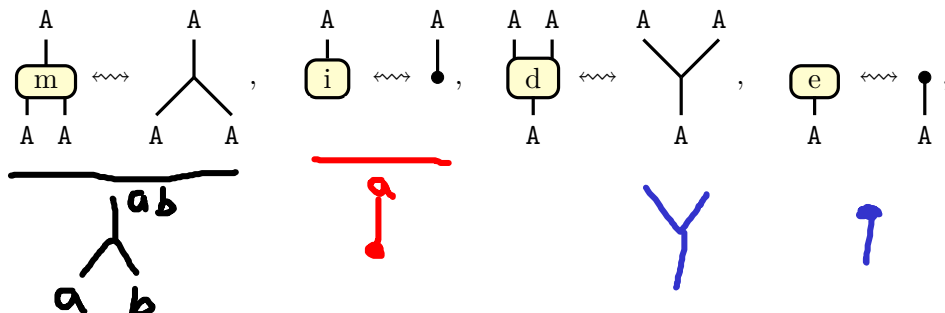

are the structure maps and

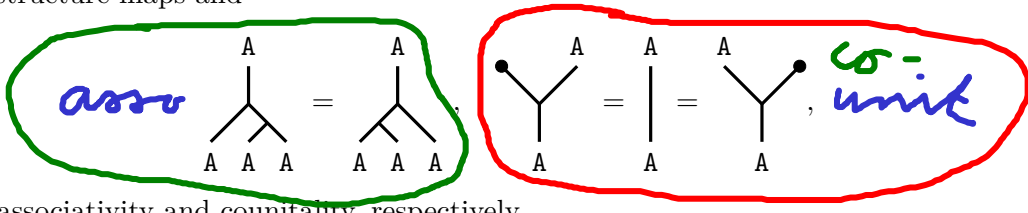

present associativity and counitality, respectively.

Example 3.31 In any monoidal category $\mathbb{1}$ has the structure of a (co)algebra. ∅ ∅

Example 3.32 Algebras and coalgebras generalize many notions:

- (a) Algebras and coalgebras in **Set** are monoids and comonoids.
- (b) Algebras and coalgebras in **Vec_k** are algebras and coalgebras over **k**.

Example 3.33 The object $\bullet^2 \in \mathbf{Br}$ (the Brauer category, see [Example 3.24](#)) is an algebra with structure maps

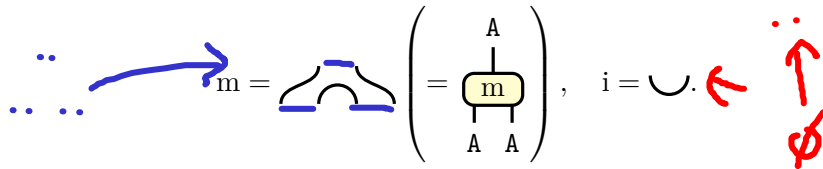

Associativity and unitality are topologically clear:

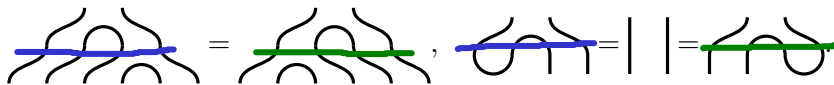

Similarly, the object $\bullet^2 \in \mathbf{Br}$ is also a coalgebra, by mirroring the diagrams.

Definition 3.34 A Frobenius algebra $A = (A, m, i, d, e)$ in \mathbf{C} is an algebra (A, m, i) and a coalgebra (A, d, e) in \mathbf{C} satisfying a compatibility condition, i.e. we have commuting diagrams

$$(3-8) \quad \begin{array}{ccc} A(AA) & \xrightarrow{\alpha_{A,A,A}} & (AA)A \\ \text{id}_A \otimes d \uparrow & & \downarrow m \otimes \text{id}_A \\ AA & \xrightarrow{m} A \xrightarrow{d} & AA \end{array} \quad \begin{array}{ccc} (AA)A & \xrightarrow{\alpha_{A,A,A}^{-1}} & A(AA) \\ d \otimes \text{id}_A \uparrow & & \downarrow \text{id}_A \otimes m \\ AA & \xrightarrow{m} A \xrightarrow{d} & AA \end{array}$$

Diagrammatically (3-8) is

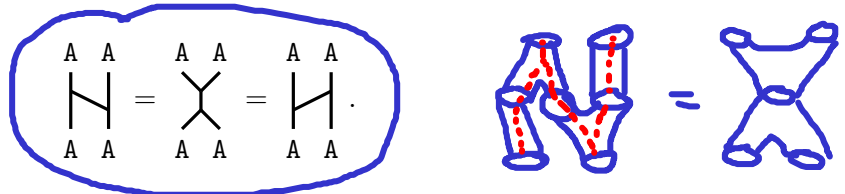

Example 3.35 Frobenius algebras in **Vec_k** are classical Frobenius algebras over **k**.

Lemma 3.36 Let A be a Frobenius algebra in a strict monoidal category. Define

$$\begin{array}{c} \text{cup} = \text{tree}, \quad \text{cup} = \text{tree} \\ \cap := \text{tree}_m^e, \quad \cup := \text{tree}_d^i \end{array}$$

Then the following hold, including mirrors:

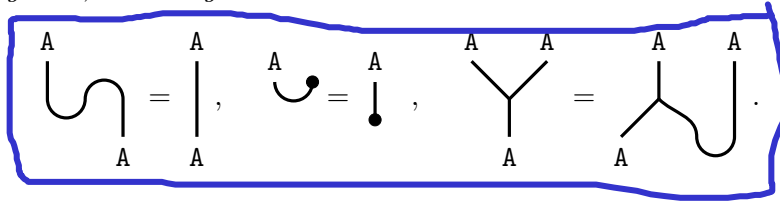

Thus, Frobenius algebras are topologically in nature since Lemma 3.36 shows that the diagrams for Frobenius algebras satisfy all planar isotopies.

Proof. This is Exercise 3.46 □

Remark 3.37 There is of course also a non-strict version of Lemma 3.36 which looks almost exactly the same.

3F. **Modules of algebras.** Arguably modules of algebras are more interesting than the algebras themselves. So:

Definition 3.38 Let A be an algebra. A **right A module** $M = (M, \cdot_-)$ in \mathcal{C} consists of

- an object $M \in \mathcal{C}$;
- a right action, i.e. a morphism $\cdot_- : MA \rightarrow M$;

such that

(i) we have a commuting diagram

$$\begin{array}{ccc}
 M(AA) & \xrightarrow{\alpha_{M,A,A}} & (MA)A \\
 \text{id}_M \otimes m \downarrow & & \downarrow (\cdot_-) \otimes \text{id}_A \\
 MA & \xrightarrow{\cdot_-} & M \longleftarrow MA
 \end{array}$$

over

(ii) we have a commuting diagram

$$\begin{array}{ccc}
 & M & \\
 \rho_M \nearrow & & \nwarrow \cdot_- \\
 M \mathbb{1} & \xrightarrow{\text{id}_M \otimes i} & MA
 \end{array}$$

unit

Definition 3.39 Let M and N be right A modules. A morphism $f : M \rightarrow N$ is said to be **A equivariant** if it intertwines the right A action, i.e. $f(\cdot_-) = (\cdot_-)f$.

In pictures these notions are again nice:

← A right

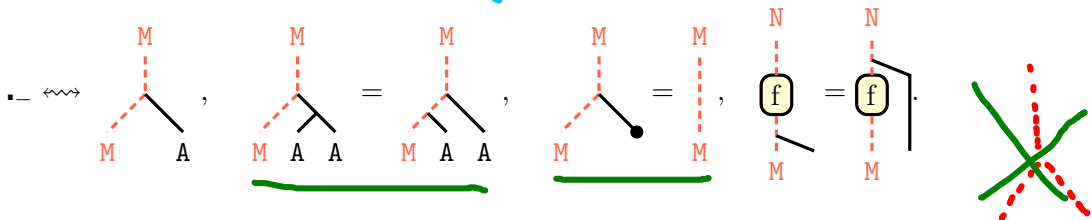

Lemma 3.40 The composition of A equivariant morphisms is A equivariant.

Proof. The proof in diagrams is easy:

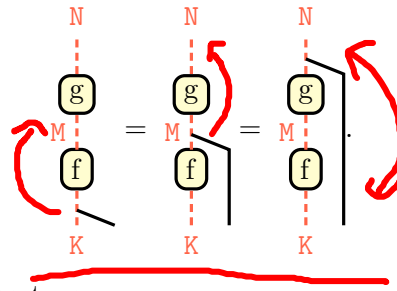

The non-strict version is thus also true. □

Since the identity is always \mathbb{A} equivariant, we get another category:

Example 3.41 We have a category $\mathbf{Mod}_{\mathbb{C}}(\mathbb{A})$, the category of right \mathbb{A} modules, whose objects are right \mathbb{A} modules and morphisms are \mathbb{A} equivariant morphisms. ✓

Example 3.42 All of these notions generalize the classical notions of algebras, modules and their categories if we work in $\mathbf{Vec}_{\mathbb{k}}$.

We leave it to the reader to write down the definitions of other classical notions from algebra in the categorical sense, see also [Exercise 3.47](#). Let us instead finish with a diagrammatic proof generalizing a classical fact which is actually messy to prove classically.

Proposition 3.43 Let \mathbb{A} be a Frobenius algebra in \mathbb{C} . Then every right \mathbb{A} module has a compatible structure of a right \mathbb{A} comodule and vice versa.

Proof. We can assume that \mathbb{C} is strict. Let M be a right \mathbb{A} module. Then we define the coaction $(\cdot)_*^{co}$ via

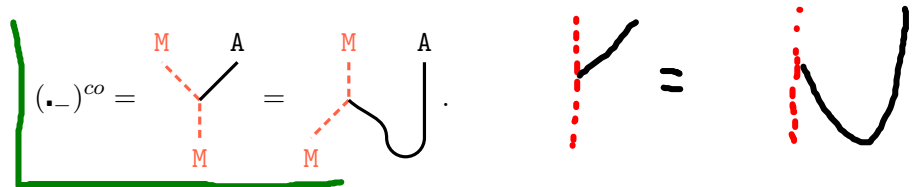

This defines a right \mathbb{A} comodule since, by [Lemma 3.36](#), we have e.g.

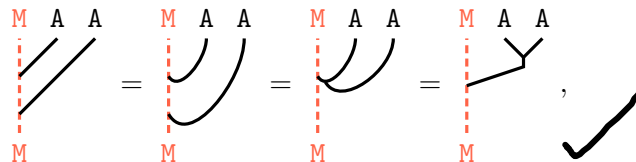

and unitality follows *mutatis mutandis*. By mirroring the diagrams we can get from comodules to modules. □

3G. Exercises.

Exercise 3.44 Let Sym_n be the symmetric group of the set $\{1, \dots, n\}$ for $n > 2$. Show that

$$\text{Sym}_n \cong \langle s_1, \dots, s_{n-1} \mid s_i^2 = 1, s_i s_{i\pm 1} s_i = s_{i\pm 1} s_i s_{i\pm 1}, s_i s_j = s_j s_i \text{ for } |i - j| > 1 \rangle$$

as groups. Deduce that $\text{End}_{\mathbf{Sym}}(\bullet^n) \cong \text{Sym}_n$.

Exercise 3.45 Recall the construction of Brauer category \mathbf{Br} from [Example 3.24](#). Prove that the defining relations (3-2) imply that the following hold in \mathbf{Br} :

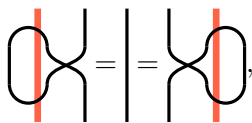

where the thick red strands represent an arbitrary number of straight strands.

Exercise 3.46 Prove [Lemma 3.36](#).

Exercise 3.47 Think about how to define right, left, bi(co)modules, their homomorphisms, subalgebras, ideals, submodules, etc. in the categorical setting, and choose your favorite notion and write down its categorical definition.

Exercise 3.48 Verify that \bullet^2 is a Frobenius algebra in \mathbf{Br} , cf. [Example 3.33](#). ✓

4. PIVOTAL CATEGORIES – DEFINITIONS, EXAMPLES AND GRAPHICAL CALCULUS

Recall that Feynman diagrams for monoidal categories in general need to be upwards oriented, i.e. they do not have Morse points. So.

What kind of categories allow Morse points in their graphical calculus?

4A. **A word about conventions.** This section is all about duals.

Convention 4.1 We will use the symbol \star for duality. Because it is always confusing, let us state right away that right duals will have their \star on the right, and left duals on the left, e.g.

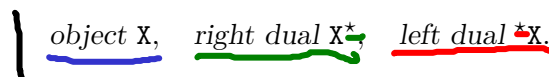

If the left and the right dual agree, then we use the right dual $-^*$ as the notation, and similar conventions for traces and dimensions.

Convention 4.2 Again, there will be several choices which we tend to omit when no confusion can arise. Moreover, whenever we write e.g. X^* we implicitly assume existence of the right dual.

Convention 4.3 For pivotal categories we use the convention that strands labeled X are directed upwards, and those labeled with duals are oriented downward, see (4-13). In particular, it suffices to label each strand once and in contrast to the general situation, cf. [Convention 1.3](#), we usually orient diagrams.

Convention 4.4 From now on we will use diagrammatics most of the time, and leave it to the reader to work out some of the non-strict versions of definitions and statements. For diagrams we use the terminology “taking mirrors” as before, but this also includes orientation reversals, e.g.

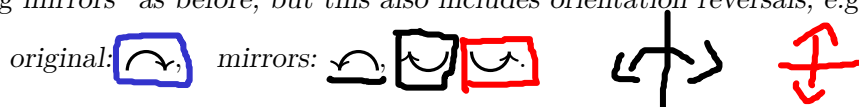

Convention 4.5 If $\text{End}_{\mathbb{C}}(\mathbb{1})$ is e.g. \mathbb{k} , then we often identify the endomorphisms with actual elements, e.g. instead of “multiplication by $a \in \mathbb{k}$ ” we just write a .

4B. Duality in monoidal categories. Since duality is a powerful concept, we start with:

Definition 4.6 A right dual $(X^*, ev_X, coev_X)$ of $X \in \mathbf{C}$ in a category $\mathbf{C} \in \mathbf{MCat}$ consists of

- an object $X^* \in \mathbf{C}$;
- a (right) evaluation ev_X and a (right) coevaluation $coev_X$, i.e. morphisms

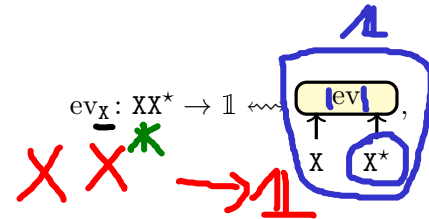
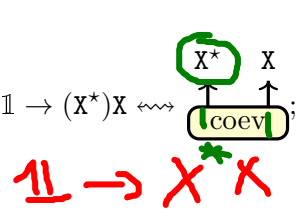
(4-1) $ev_X: XX^* \rightarrow \mathbb{1} \iff$  , $coev_X: \mathbb{1} \rightarrow (X^*)X \iff$  ;

such that they are non-degenerate, i.e.

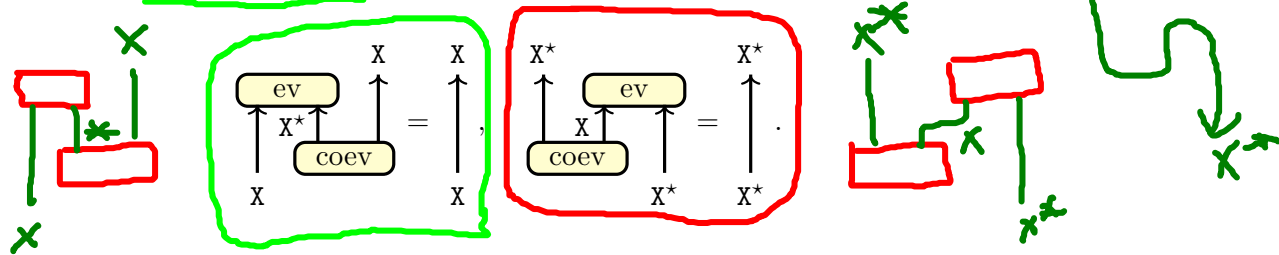
(4-2) 

Similarly, a left dual $({}^*X, ev^X, coev^X)$ of $X \in \mathbf{C}$ in a category $\mathbf{C} \in \mathbf{MCat}$ consists of

- an object ${}^*X \in \mathbf{C}$;
- a (left) evaluation ev^X and a (left) coevaluation $coev^X$, i.e. morphisms

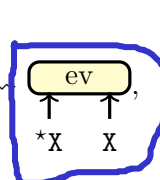
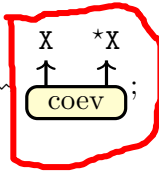
(4-3) $ev^X: {}^*XX \rightarrow \mathbb{1} \iff$  , $coev^X: \mathbb{1} \rightarrow X({}^*X) \iff$  ;

such that they are non-degenerate, i.e.

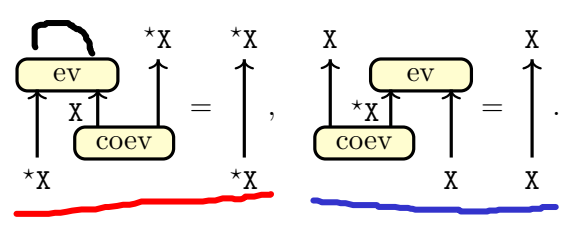
(4-4) 

We call (4-2) and (4-4) the zigzag relations.

Remark 4.7 Note that we do not distinguish the right and left (co)evaluation in coupons since the position of \star will determine whether its right or left, cf. (4-1) and (4-3).

The following justifies to say “the” right and left dual.

Lemma 4.8 Right and left duals, if they exist are unique up to unique isomorphism.

Proof. Let X^* and \bar{X}^* be two right duals of X . These come with evaluation and coevaluation morphisms, ev_X and $coev_X$, and \bar{ev}_X and \bar{coev}_X , respectively. We use these to define two morphisms

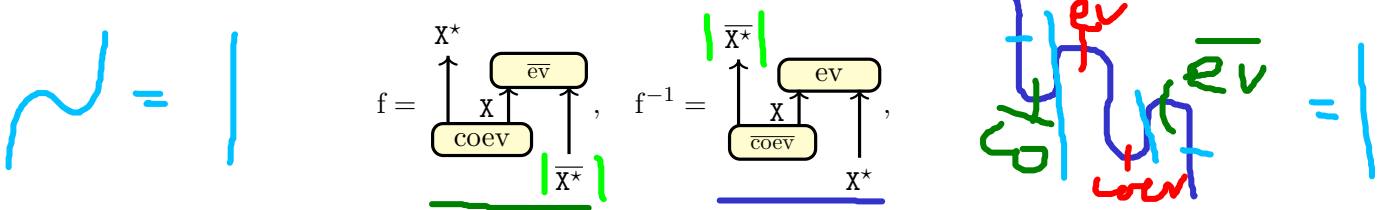

which are inverses by the zigzag relations. Moreover, it is easy to check that f is the only isomorphism which preserves the (co)evaluation. The proof for left duals is similar. \square

Lemma 4.9 Fix $C \in \mathbf{MCat}$.

(i) The monoidal unit is self-dual, meaning

$$\mathbb{1} \cong \mathbb{1}^* \cong {}^*\mathbb{1}.$$

(ii) For any $X \in C$ which has a right and a left dual we have

$$(4-5) \quad {}^*(X^*) \cong X \cong ({}^*X)^*.$$

(iii) If $X \in C$ has a right dual, then $X \in C^{co}$ has a left dual, and vice versa.

Proof. (i). This follows since we can take the unitors as (co)evaluation morphisms.

(ii). The isomorphisms are similar to the ones in the proof of Lemma 4.8, where we again use the zigzag relations to show that they invert one another.

(iii). Clear by comparing (4-1) and (4-3). \square

Lemma 4.9.(iii) is the first instance of what we call right-left symmetry. It says in words that “Every statement about right duals has a left counterpart and vice versa.”

4C. **Some first examples of duals.** The following can be taken as an example or as our definition of adjoint functors:

Example 4.10 In the monoidal category $\mathbf{End}(C)$, cf. Example 2.24, the right dual F^* of a functor is called its right adjoint, while the left dual *F is called its left adjoint.

Duals in general might not exist, e.g. not every functor has adjoints. A more down to earth example is:

Example 4.11 Not every objects in \mathbf{Vec}_k has duals. However, if X is finite dimensional, then $X^* = {}^*X$ is the vector space dual with the (co)evaluations being the usual maps, e.g.

$$ev_X: X X^* \rightarrow k, (x, y^*) \mapsto y^*(x), \quad coev_X: k \rightarrow (X^*)X, 1 \mapsto \sum_{i=1}^n x_i^* \otimes x_i,$$

where $\{x_1, \dots, x_n\}$ and $\{x_1^*, \dots, x_n^*\}$ are choices of dual bases of X and X^* .

Example 4.12 Most of the diagrammatic categories which we have seen have duals. For example, in \mathbf{TL} or \mathbf{Br} the generating object \bullet is self-dual. More precisely,

$$\bullet = \bullet^* = {}^*\bullet, \quad \underbrace{ev_\bullet = ev^{\bullet} = \cap}_{\text{blue}}, \quad \underbrace{coev_\bullet = coev^{\bullet} = \cup}_{\text{red}},$$

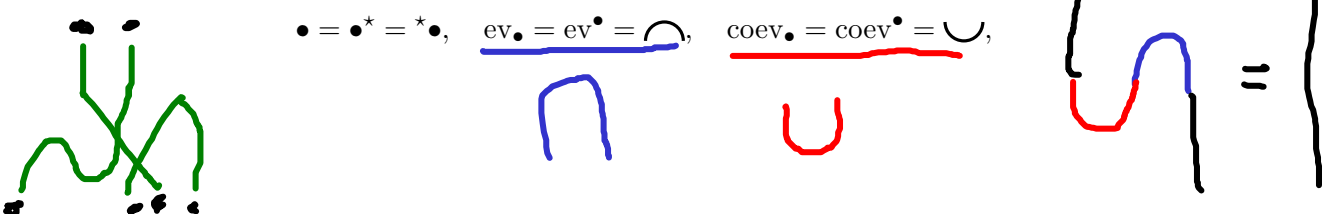



where the evaluation and the coevaluation are cap and cup morphisms, as illustrated. In the algebraic model of **1State**, the oriented quantum Brauer category oqBr, we have $\bullet^* = *\bullet$ with (3-5) being the four (co)evaluations.

Note that duals, if they exist, are unique, but the evaluation and coevaluation are not unique. In particular, they usually can be scaled if we are in a \mathbb{k} linear setting. The crucial example where scaling will matter later on is:

Example 4.13 Let us consider $\text{Vec}_{\mathbb{C}}^{\omega}(\mathbb{Z}/2\mathbb{Z})$ for the non-trivial 3 cocycle ω . In this category all objects are self-dual, i.e. $1 = 1^* = *1$ and

$$\underline{11^* = 0}, \quad \underline{(1^*)1 = 0}.$$

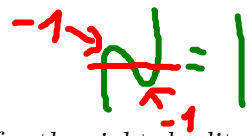

But the object 1 admits several (co)evaluations, which we explain for the right duality, the left being similar by right-left symmetry. The (hidden) associativity constraints in (4-2) are

$$\underline{1 \xrightarrow{\text{id}_1 \otimes \text{coev}_1} 1(11) \xrightarrow{\alpha_{1,1,1}} (11)1 \xrightarrow{\text{ev}_1 \otimes \text{id}_1} 1}, \quad 1 \xrightarrow{\text{coev}^1 \otimes \text{id}_1} (11)1 \xrightarrow{\alpha_{1,1,1}^{-1}} 1(11) \xrightarrow{\text{id}_1 \otimes \text{ev}^1} 1.$$

Thus, recalling that $\alpha_{1,1,1}$ gives a sign, whatever non-zero scalar $a \in \mathbb{C}^*$ we like to scale ev_1 with, we then need to scale coev_1 by $-a^{-1}$. The minus sign is the crucial part here: one can also scale the (co)evaluations for 0, but then only with a and a^{-1} .

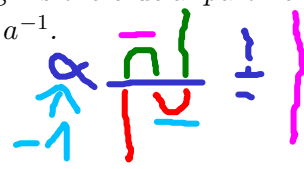

Duality is actually a functor, as we will see next.

Definition 4.14 For $(f: X \rightarrow Y) \in \mathbf{C}$, in a category $\mathbf{C} \in \text{MCat}$, its right $f^*: Y^* \rightarrow X^*$ and left mate $*f: *Y \rightarrow *X$ are defined as

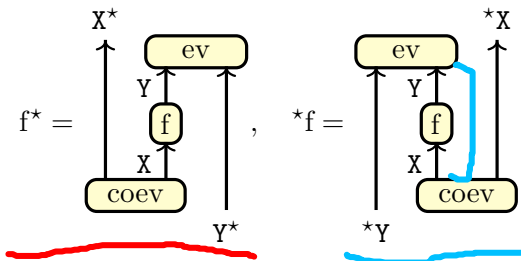

Lemma 4.15 Fix any $\mathbf{C} \in \text{MCat}$. Then, for all $X, Y, f, g \in \mathbf{C}$:

(i) We have $(gf)^* = (f^*)(g^*)$ and $*(gf) = (*f)(*g)$.

(ii) We have $(XY)^* \cong (Y^*)(X^*)$ and $*(XY) \cong (*Y)(*X)$.

Proof. This is [Exercise 4.67](#). □

The most useful consequence of having duals in practice is:

Theorem 4.16 Let $X, Y, Z \in \mathbf{C}$ be objects in any $\mathbf{C} \in \text{MCat}$. Then we have

$$\underline{\text{Hom}_{\mathbf{C}}(XY, Z) \cong \text{Hom}_{\mathbf{C}}(Y, (X^*)Z)}, \quad \underline{\text{Hom}_{\mathbf{C}}(YX, Z) \cong \text{Hom}_{\mathbf{C}}(Y, Z(*X))},$$

$$\underline{\text{Hom}_{\mathbf{C}}(Y, ZX) \cong \text{Hom}_{\mathbf{C}}(YX^*, Z)}, \quad \underline{\text{Hom}_{\mathbf{C}}(Y, XZ) \cong \text{Hom}_{\mathbf{C}}(*XY, Z)}.$$

(Of course assuming that the corresponding duals exist for X .)

$$\text{Hom}(X, Y) \cong \text{Hom}(1, (X^*)Y)$$

Proof. Let us construct isomorphisms for the first case, all others cases are similar. We define

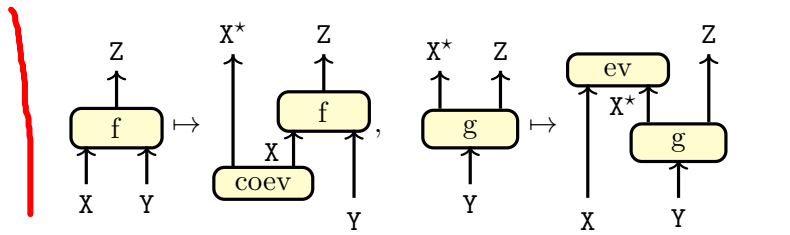

That these are inverses follows from the zigzag relations. □

Proposition 4.17 Let $F \in \mathbf{Hom}_{\otimes}(\mathbf{C}, \mathbf{D})$. If X^* is a right dual of $X \in \mathbf{C}$, then $F(X^*)$ is a right dual of $F(X) \in \mathbf{D}$. Similarly for left duals.

Proof. By right-left symmetry, it suffices to define

$$\begin{aligned} \text{ev}_{F(X)}: F(X)F(X^*) &\xrightarrow{\xi_{X, X^*}} F(XX^*) \xrightarrow{F(\text{ev}_X)} F(\mathbb{1}) \xrightarrow{\xi_{\mathbb{1}}^{-1}} \mathbb{1}, \\ \text{coev}_{F(X)}: \mathbb{1} &\xrightarrow{\xi_{\mathbb{1}}} F(\mathbb{1}) \xrightarrow{F(\text{coev}_X)} F((X^*)X) \xrightarrow{\xi_{X^*, X}^{-1}} F(X^*)F(X). \end{aligned}$$

These are the corresponding (co)evaluations, as a straightforward calculation verifies. □

4D. **Rigidity.** Recall that duals might not exist. This motivates:

Definition 4.18 A category $\mathbf{C} \in \mathbf{MCat}$ is called rigid if every object has right and left duals.

Example 4.19 Several examples which we have seen are rigid.

- (a) fdVec_k is rigid, cf. Example 4.11.
- (b) Vec_k^ω(G) (for the duration, we will always use the \mathbb{k} linear incarnation of $\mathbf{Vec}^\omega(G)$) is rigid with $g^{-1} = g^* = {}^*g$.
- (c) The diagrammatic categories TL and Br are rigid with a self-dual generator •.
- (d) The diagrammatic categories oTL and oBr are rigid with •* = *•.

Let $X^{**} = (X^*)^*$ and ${}^{**}X = {}^*(X^*)$ denote the double duals. Note that all the examples in Example 4.19 satisfy

$$(4-6) \quad X^* \cong {}^*X \xrightarrow{(4-5)} X^{**} \cong X \cong {}^{**}X.$$

This is not always true:

Example 4.20 The free rigid category generated by one object • has

$$(4-7) \quad \bullet^* \not\cong \bullet \bullet \implies \bullet^{**} \not\cong \bullet \bullet \bullet.$$

The proof of (4-7) this requires non-trivial arguments, i.e. by constructing models: examples where (4-6) fails exist, but are not easy to construct.

Not always $X^{**} = X$!

Example 4.21 By [Proposition 4.17](#), we see that monoidal functors are already the correct morphisms between rigid categories, as long as we do not care for the choices of (co)evaluations. Thus, we get the category of rigid categories \mathbf{RCat} .

Lemma 4.22 If $\mathbf{C} \in \mathbf{RCat}$, then $\mathbf{C}^{op}, \mathbf{C}^{co}, \mathbf{C}^{coop} \in \mathbf{RCat}$

Proof. Immediate by taking mirrors of diagrams. \square

[Lemma 4.15](#) shows that we can define important functors between rigid categories:

Definition 4.23 For $\mathbf{C} \in \mathbf{RCat}$ we define **right and left duality functors**

$$\underline{-}^*: \mathbf{C} \rightarrow \mathbf{C}^{coop}, \quad \mathbf{X} \mapsto \mathbf{X}^*, \quad \mathbf{f} \mapsto \mathbf{f}^*, \quad \mathbf{*}_-: \mathbf{C}^{coop} \rightarrow \mathbf{C}, \quad \mathbf{X} \mapsto \mathbf{*}\mathbf{X}, \quad \mathbf{f} \mapsto \mathbf{*}\mathbf{f}.$$

Proposition 4.24 For $\mathbf{C} \in \mathbf{RCat}$ we have equivalences

$$(4-8) \quad \underline{-}^*: \mathbf{C} \xrightarrow{\simeq_{\otimes}} \mathbf{C}^{coop}, \quad \mathbf{*}_-: \mathbf{C}^{coop} \xrightarrow{\simeq_{\otimes}} \mathbf{C},$$

$$(4-9) \quad \mathbf{*}(\underline{-}^*) \cong \text{Id}_{\mathbf{C}}, \quad (\mathbf{*}_-)^* \cong \text{Id}_{\mathbf{C}^{coop}}.$$

Proof. As usual it suffices to prove (4-8) for the right duality. By [Lemma 4.15](#) we see that $\underline{-}^*$ is a well-defined monoidal functor, while [Theorem 4.16](#) shows fully faithfulness of $\underline{-}^*$. Moreover, (4-5) proves that $\underline{-}^*$ is dense, thus, an equivalence. The second part (4-9) follows easily from (4-6). \square

Remark 4.25 The only reason to define the right duality be a functor from \mathbf{C} to \mathbf{C}^{coop} and the left duality the other way around is to get a cleaner statement in (4-9), but for the duration we rather have the left duality also defined to be from \mathbf{C} to \mathbf{C}^{coop} . Furthermore, alternatively right and left dualities also give equivalences (either way) $\mathbf{C}^{op} \simeq_{\otimes} \mathbf{C}^{co}$.

Immediate consequences of [Proposition 4.24](#) are:

Proposition 4.26 For $\mathbf{C} \in \mathbf{RCat}$ we have equivalences

$$(4-10) \quad \underline{-}^{**}: \mathbf{C} \xrightarrow{\simeq_{\otimes}} \mathbf{C}, \quad \mathbf{**}_-: \mathbf{C} \xrightarrow{\simeq_{\otimes}} \mathbf{C}.$$

Both equivalences can also be stated between \mathbf{C}^{op} and \mathbf{C}^{op} , \mathbf{C}^{co} and \mathbf{C}^{co} , or \mathbf{C}^{coop} and \mathbf{C}^{coop} . \square

Proposition 4.27 For any rigid category \mathbf{C} its Grothendieck classes $K_0(\mathbf{C})$ form a monoid, with multiplication and unit as in [Proposition 2.10](#), and two homomorphisms

$$[\underline{-}^*]: K_0(\mathbf{C}) \rightarrow K_0(\mathbf{C}^{coop}), \quad [\mathbf{X}] \mapsto [\mathbf{X}^*], \quad [\mathbf{*}_-]: K_0(\mathbf{C}) \rightarrow K_0(\mathbf{C}^{coop}), \quad [\mathbf{X}] \mapsto [\mathbf{*}\mathbf{X}].$$

Moreover, they are inverse of one another.

Proof. By [Lemma 4.15](#) we have

$$[(\mathbf{X}\mathbf{Y})^*] = [\mathbf{Y}^*\mathbf{X}^*] = [\mathbf{Y}^*][\mathbf{X}^*]$$

and we get the left analog by right-left symmetry. They are inverses by (4-5). \square

Example 4.28 On $K_0(\mathbf{fdVec}_k)$, cf. [Example 1.45](#), the two homomorphisms $[\underline{-}^*]$ and $[\mathbf{*}_-]$ agree and are the identities.

Let us now take care of the choice of (co)evaluations:

Definition 4.29 A functor $F \in \mathbf{Hom}_\otimes(\mathbf{C}, \mathbf{D})$ for $\mathbf{C}, \mathbf{D} \in \mathbf{RCat}$ is called rigid if

$$F(\underline{\text{ev}}_X) = \underline{\text{ev}}_{F(X)}, \quad F(\underline{\text{coev}}_X) = \underline{\text{coev}}_{F(X)}, \quad F(\underline{\text{ev}}^X) = \underline{\text{ev}}^{F(X)}, \quad F(\underline{\text{coev}}^X) = \underline{\text{coev}}^{F(X)},$$

holds for all $X \in \mathbf{C}$.

The following lemma is immediate.

Lemma 4.30 The identity functor on a rigid category is rigid. Moreover, if F and G are rigid functors, then so is GF . □

Example 4.31 We get a (dense, in the monoidal sense, but non-full) subcategory $\mathbf{R}^+\mathbf{Cat} \subset \mathbf{RCat}$, the category of rigid categories and rigid functors. Also, we have a (non-dense, but full) subcategory $\underline{\mathbf{Hom}}_\star(\mathbf{C}, \mathbf{D}) \subset \mathbf{Hom}_\otimes(\mathbf{C}, \mathbf{D})$, the category rigid functors.

Definition 4.32 $\mathbf{C}, \mathbf{D} \in \mathbf{RCat}$ are called equivalent as rigid categories, denoted by $\underline{\mathbf{C}} \simeq_\star \underline{\mathbf{D}}$, if there exists an equivalence $F \in \underline{\mathbf{Hom}}_\star(\mathbf{C}, \mathbf{D})$.

Example 4.33 Recall that $\mathbf{Vec}_{\mathbb{C}}^\omega(\mathbb{Z}/2\mathbb{Z})$ allowed several choices of (co)evaluations, some of which differ by signs. A monoidal functor does not take these choices into account, so they are all monoidally equivalent. However, Lemma 4.62 below will show that not all of these choice give \simeq_\star equivalent rigid categories.

↓

N=1

4E. **Categorical groups.** In some sense, see also Example 4.19.(b) or Exercise 4.69, rigid categories are like categorical versions of groups. Let us make this a bit more precise.

Definition 4.34 Let $\mathbf{C} \in \mathbf{RCat}$. Then $X \in \mathbf{C}$ is called invertible if $\text{ev}_X: XX^* \rightarrow \mathbb{1}$ and $\text{coev}_X: \mathbb{1} \rightarrow (X^*)X$ are isomorphisms.

That Definition 4.34 seems to favor right over left is a mirage:

Lemma 4.35 If $X, Y \in \mathbf{C}$ are invertible, then:

- (i) We have $X^* \cong {}^*X$.
- (ii) The object X^* is invertible.
- (iii) The object XY is invertible.

Proof. (i). Note that we have $XX^* \cong \mathbb{1} \cong (X^*)X$ by invertibility of X . Thus, taking duals we also have ${}^*XX \cong \mathbb{1} \cong X({}^*X)$, which we can put together to get $X^* \cong (X^*)X({}^*X) \cong {}^*X$.

(ii). Clear by (4-5).

(iii). This follows since ev_{XY} , respectively coev_{XY} , can be defined as compositions of ev_X with ev_Y , respectively of coev_X with coev_Y . □

Example 4.36 *Lemma 4.35* says that we get a monoidal category $\text{Inv}(\mathbf{C})$ as well as a group $\text{Inv}(\mathbf{C}) = \text{Inv}(K_0(\mathbf{C}))$ of invertible objects.

Definition 4.37 Let $\mathbf{C} \in \mathbf{RCat}$. Then \mathbf{C} is called a categorical group if $\text{Inv}(\mathbf{C}) = \mathbf{C}$.

Example 4.38 With respect to the examples in *Example 4.19*:

(i) $\text{Inv}(\mathbf{fdVec}_k)$ has, up to isomorphisms, only the object \mathbb{k} . Hence, $\text{Inv}(\mathbf{fdVec}_k) \cong 1$, which is the submonoid of invertible elements in $K_0(\mathbf{fdVec}_k) \cong \mathbb{N}$.

(ii) For $\mathbf{Vec}_k^\omega(G)$ one clearly has $\text{Inv}(\mathbf{Vec}_k^\omega(G)) \cong K_0(\mathbf{Vec}_k^\omega(G)) \cong G$, and $\mathbf{Vec}_k^\omega(G)$ is a categorical group.

(iii) For the diagrammatic categories à la Brauer one always has $\text{Inv}(\mathbf{Br}) \cong 1$.

4F. **Pivotality.** Note that *Example 4.20* shows that the equivalences from (4-10) might not be trivial. In fact, they can be of infinite order. This motivates the following definition.

Definition 4.39 A category $\mathbf{C} \in \mathbf{RCat}$ is called pivotal if ${}_{-}^* \cong_{\otimes} {}^*_{-}$. A pivotal structure on a pivotal category is a choice of an isomorphism $\pi: {}_{-}^* \xrightarrow{\cong_{\otimes}} {}^*_{-}$.

In other words, in a pivotal category we have (4-6). Thus:

Proposition 4.40 For any pivotal category \mathbf{C} we have $\text{Id}_{\mathbf{C}} \cong_{\otimes} {}_{-}^{**} \cong_{\otimes} {}^{**}_{-}$, and hence the functor ${}_{-}^* \cong_{\otimes} {}^*_{-}$ is of order two. □

On the other hand, a pivotal structure on a pivotal category is a further choice of isomorphisms

$$(4-11) \quad \pi_X: X^* \xrightarrow{\cong} {}^*X,$$

natural in X , satisfying $\pi_{XY} = \pi_X \otimes \pi_Y$. Alternatively, a pivotal structure on a pivotal category is a further choice of isomorphisms

$$(4-12) \quad \pi_X: X \xrightarrow{\cong} X^{**},$$

satisfying exactly the same conditions.

Remark 4.41 It is more natural to define a pivotal structure as isomorphisms identifying right and left duals, i.e. using (4-11). However, in practice the choice of isomorphisms as in (4-12) turns out to be more useful, and we will use both interchangeable.

Example 4.42 All examples in *Example 4.19* are pivotal. More precisely:

- (a) \mathbf{fdVec}_k has a pivotal structure coming from the classical \mathbb{k} vector space duality $V \cong V^{**}$.
- (b) For $\mathbf{Vec}_k(G)$ one can choose the pivotal structure to be the identity.
- (c) The diagrammatic categories à la Brauer usually have $\bullet^* = {}^*\bullet$ or even $\bullet = \bullet^* = {}^*\bullet$, which gives them an evident pivotal structure.

Example 4.43 Note the difference between being free:

- (a) The free rigid category generated by one object \bullet , cf. [Example 4.20](#), is not pivotal.
- (b) The free pivotal category generated by one object \bullet is oTL.
- (c) The free pivotal category generated by one self-dual object \bullet is TL.

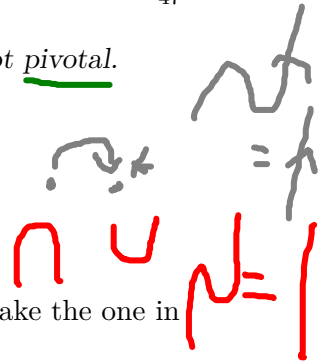

In these notes we tend to omit to choose a pivotal structure. To be precise, we take the one in (4-17) which only involves choices of (co)evaluations, so:

Example 4.44 We also have the category $\mathbf{PCat} \subset \mathbf{R}^+\mathbf{Cat}$, the **category of pivotal categories**, whose morphisms are rigid functors.

Lemma 4.45 In a pivotal category right and left mates are conjugate, i.e. $\pi_X f^* = {}^*f \pi_Y$, where $\pi: {}^*_* \xrightarrow{\cong} {}^*_*$ is a choice of pivotal structure.

Proof. The claim follows directly from ${}_-* \cong {}^*_*$ and its commuting diagram. □

Definition 4.46 A category $\mathbf{C} \in \mathbf{PCat}$ is called **strict**, if ${}_-* = {}^*_*$ as functors.

Thus, we can write f^* for the mate in case $\mathbf{C} \in \mathbf{PCat}$ is strict.



Similarly as in [Theorem 2.32](#) we have the pivotal strictification, which we will use in all diagrams:

Theorem 4.47 For any pivotal category \mathbf{C} there exists a strict pivotal category \mathbf{C}^{st} which is pivotal equivalent to \mathbf{C} , i.e. $\mathbf{C} \simeq_* \mathbf{C}^{st}$.

Proof. It is not hard, but also not trivial, to generalize the arguments in [Theorem 2.32](#) to pivotal categories by constructing an appropriate functor category, see e.g. [NS07, Theorem 2.2]. Alternatively, this can be deduced from a version of the monoidal coherence theorem for pivotal categories similarly as the proof of [Theorem 2.32](#) can be deduced from [Theorem 2.19](#). (Such a pivotal coherence theorem is stated in [BW99, Theorem 1.9].) Details are omitted for brevity. □

4G. Feynman diagrams for pivotal categories. The diagrams we can draw for strict pivotal categories are now topological in nature, as well will see. The diagrammatic conventions are the ones for monoidal categories, see e.g. (2-7), together with diagrammatic rules for duals:

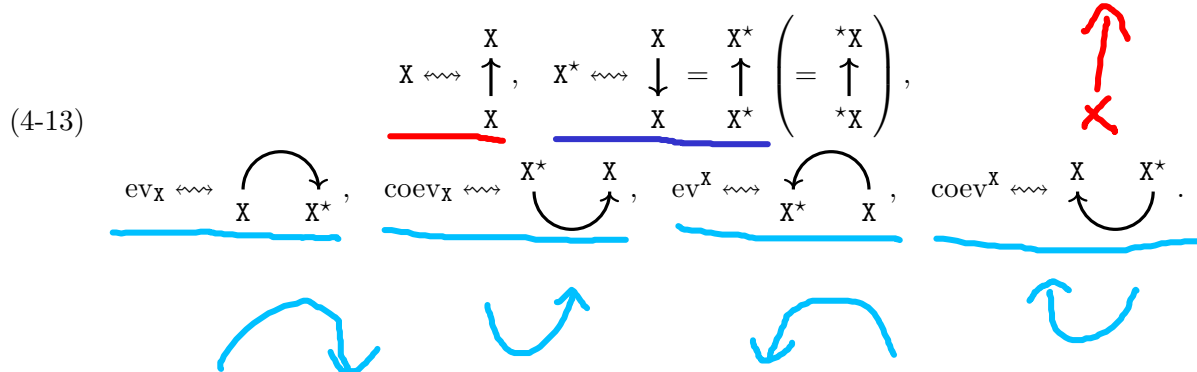

Note our reading conventions for duals, see also [Convention 4.3](#). The zigzag relations (4-2) and (4-4) in these diagrams are

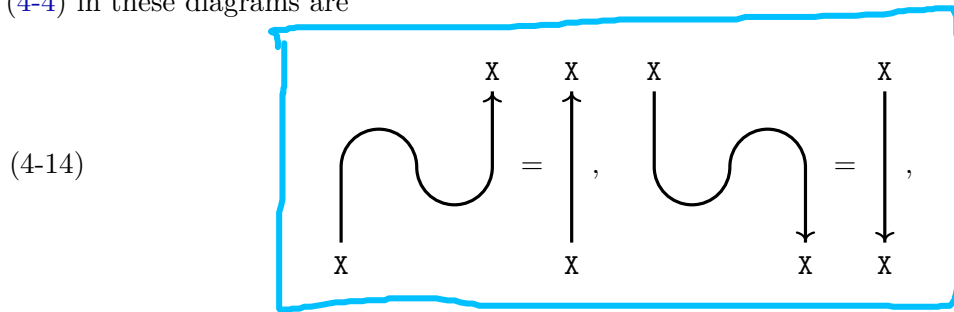

including mirrors, which imply:



Let us prove some lemmas using these diagrammatics.

Lemma 4.48 For all $f \in \mathbf{C}$, where $\mathbf{C} \in \mathbf{PCat}$, we have

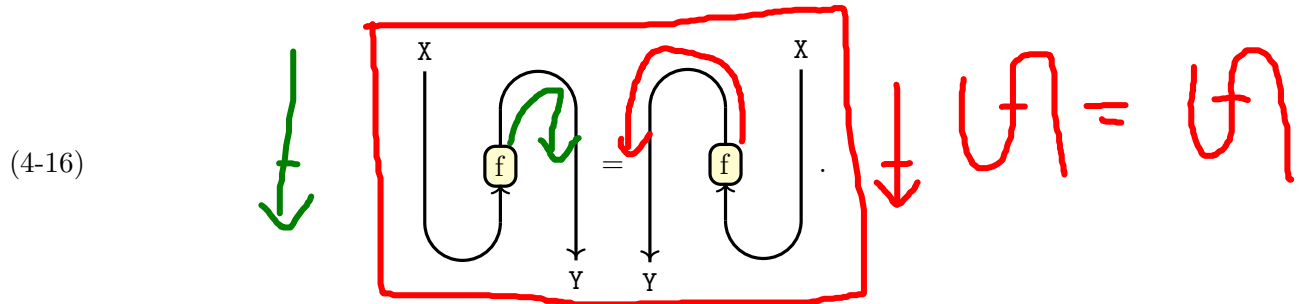

Proof. We calculate

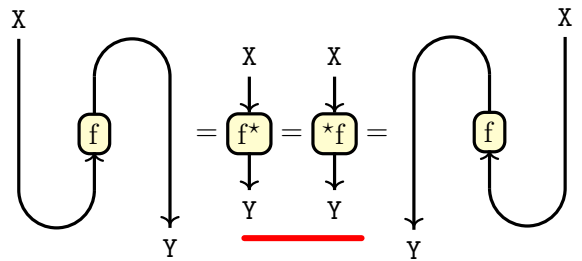

which is an application of [Lemma 4.45](#). □

Lemma 4.49 For all $f \in \mathbf{C}$, where $\mathbf{C} \in \mathbf{PCat}$, we have

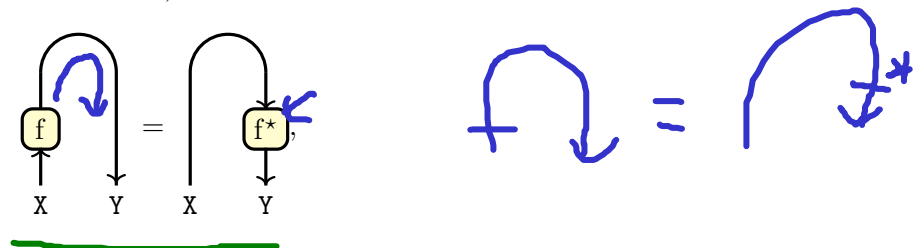

including mirrors.

These relations are called sliding.

Proof. Using (4-15) this is easy:

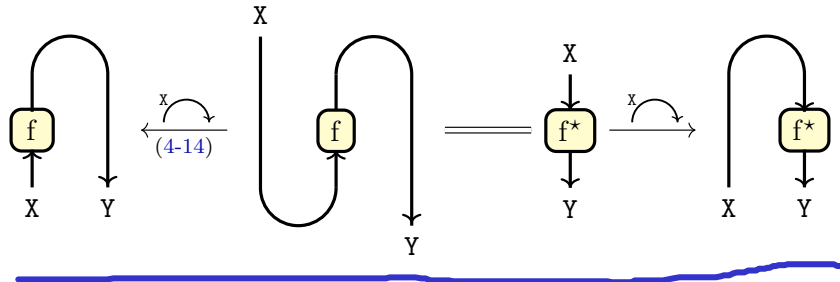

where we have used (4-14). □

Recall that a pivotal structure was an additional choice of an isomorphism $\pi_X: X \xrightarrow{\cong} X^{**}$. One such choice, sometimes called the canonical choice, is

(4-17) $\pi_X^{can}: X \rightarrow X^{**}$, $\pi_X =$ $.$

The colored marker is a shorthand notation for the corresponding identity morphism, which we also use below for different identities.

Lemma 4.50 *For all $X \in \mathbf{C}$, where $\mathbf{C} \in \mathbf{PCat}$, the morphism π_X^{can} is invertible and*

$$\pi_X^{can} = \text{Diagram 1} = \text{Diagram 2}, \quad (\pi_X^{can})^{-1} = \text{Diagram 3} = \text{Diagram 4}.$$

Proof. Note that, by definition, markers are identities and just turn orientations on diagrams around. Moreover, they are morphisms, so they slide. Hence, we have the diagrammatic equations

$$\begin{array}{c} X \\ \uparrow \\ \text{---} \\ \uparrow \\ X \end{array} = \begin{array}{c} X \\ \uparrow \\ \text{---} \\ \uparrow \\ X \end{array}, \quad \begin{array}{c} \text{---} \\ \downarrow \\ X \end{array} = \begin{array}{c} \text{---} \\ \downarrow \\ X \end{array},$$

including mirrors. Now

is one of the equalities we need to check; the others being similar. □

Example 4.51 *The canonical pivotal structure in examples is as follows.*

(i) Using the choice and notation from [Example 4.11](#) for \mathbf{fdVec}_k , we see that

$$\begin{array}{c} X^* \\ \curvearrowright \\ X \end{array} : X \rightarrow X^{**}, x \mapsto \sum_{i=1}^n x \otimes x_i^* \otimes x_i^{**} \mapsto x^{**},$$

which is independent of the choice of dual bases.

(ii) Recall from [Example 4.13](#) that for $\mathbf{Vec}_C^{\omega}(\mathbb{Z}/2\mathbb{Z})$ the (co)evaluations are basically multiplication with ± 1 , giving the two possible choices

$$\pi_1^{can}: 1 \rightarrow 1, 1 \mapsto 1, \quad \pi_1^{can}: 1 \rightarrow 1, 1 \mapsto -1.$$

The formal rule of manipulation of these diagrams is:

(4-18) "Two diagrams are equivalent if they are related by scaling or by a planar isotopy."

Theorem 4.52 *The graphical calculus is consistent, i.e. two morphisms are equal if and only if their diagrams are related by (4-18).*

Proof. Note that it is crucial to have $X \cong X^{**}$ which is key to have well-defined diagrammatics:

$$(4-19) \quad \begin{array}{ccc} X^{**} & X^* & X \\ \uparrow & = & \downarrow = \uparrow \\ X^{**} & X^* & X \end{array},$$

and the isomorphism between the left and right sides in (4-19) is the choice of pivotal structure, see e.g. (4-17). Moreover, the zigzag relations in terms of diagrams (4-14) and the identification of functors $-^* = {}^*_-$, which gives (4-16), ensure that one has all planar isotopies. \square

4H. Generalizing traces. Let us continue with a motivating example.

Example 4.53 Take \mathbf{Mat}_k , the skeleton of \mathbf{Vec}_k , which is pivotal with

$$\underline{n = n^* = {}^*n}, \quad \underline{ev_n = ev^n: nn \rightarrow 1}, \quad \underline{ev_n = (e_1 \dots e_n)}, \quad \underline{coev_n = coev^n: 1 \rightarrow nn}, \quad \underline{coev_n = \begin{pmatrix} e_1 \\ \vdots \\ e_n \end{pmatrix}}.$$

Here $\{e_1, \dots, e_n\}$ denotes the standard basis of k^n (which is secretly \underline{n} , of course). Thus, given any $f = (a_{ij})_{i,j=1, \dots, n} \in \mathbf{End}_{\mathbf{Mat}_k}(n)$, we can calculate, keeping [Convention 4.5](#) in mind, that

$$\begin{array}{c} \text{trace}(f) \\ \left(\begin{array}{c} \text{f} \\ \text{f} \end{array} \right)_n = n \left(\begin{array}{c} \text{f} \\ \text{f} \end{array} \right) = \sum_{i=1}^n a_{ii}. \end{array}$$

This is the classical trace of the matrix f . Very explicitly, if $n = 2$ and $f = \begin{pmatrix} a & b \\ c & d \end{pmatrix}$, then the calculation boils down to the matrix multiplication

$$\underbrace{\begin{pmatrix} 1 & 0 & 0 & 1 \end{pmatrix}}_{ev_2} \underbrace{\begin{pmatrix} a & b & 0 & 0 \\ c & d & 0 & 0 \\ 0 & 0 & a & b \\ 0 & 0 & c & d \end{pmatrix}}_{f \otimes id_2} \underbrace{\begin{pmatrix} 1 \\ 0 \\ 0 \\ 1 \end{pmatrix}}_{coev_2} = a + d.$$

Moreover, we get the dimension of n via

$$\underline{\text{circle}_n = n \text{ circle} = n} = \dim(n) = n$$

Definition 4.54 For $f \in \text{End}_{\mathbf{C}}(X)$, where $\mathbf{C} \in \mathbf{PCat}$, we define the right trace $\text{tr}^{\mathbf{C}}(f)$ and left trace ${}^{\mathbf{C}}\text{tr}(f)$ as the endomorphisms $\text{tr}^{\mathbf{C}}(f), {}^{\mathbf{C}}\text{tr}(f) \in \text{End}_{\mathbf{C}}(\mathbb{1})$ given by

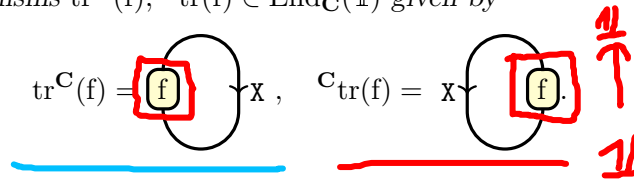

Definition 4.55 For $X \in \mathbf{C}$, where $\mathbf{C} \in \mathbf{PCat}$, we define the right dimension $\text{dim}^{\mathbf{C}}(X)$ and left dimension ${}^{\mathbf{C}}\text{dim}(X)$ as the endomorphisms $\text{dim}^{\mathbf{C}}(X), {}^{\mathbf{C}}\text{dim}(X) \in \text{End}_{\mathbf{C}}(\mathbb{1})$ given by

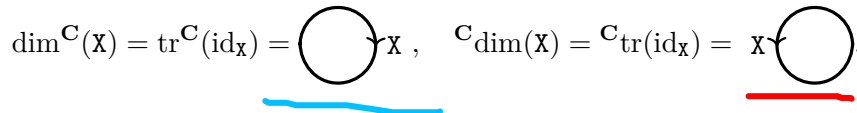

Definition 4.56 A category $\mathbf{C} \in \mathbf{PCat}$ is called spherical if

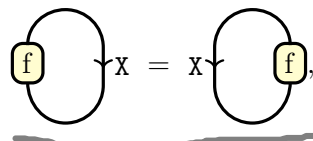

for $X \in \mathbf{C}$ and all $f \in \text{End}_{\mathbf{C}}(X)$.

Remark 4.57 The name “spherical” comes from the idea that we can also see Feynman diagrams for endomorphisms as living on a sphere rather than being planar. Then

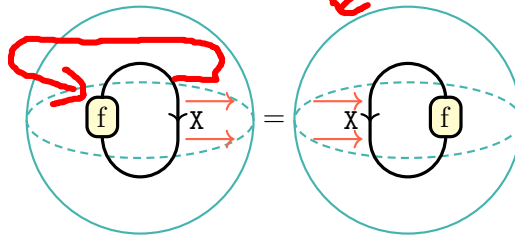

is just an isotopy which moves the strand around the sphere, a.k.a. the **lasso move**.

Example 4.58 We have already seen in [Example 4.53](#) that traces and dimensions generalize traces and dimensions for matrices. Here are a few more examples.

- (a) The category \mathbf{fdVec}_k with the standard (co)evaluations is spherical and traces and dimensions are the basis free definitions of the ones for \mathbf{Mat}_k .
- (b) The category $\mathbf{Vec}_k^\omega(G)$ with the standard (co)evaluations is spherical and one has $\dim^{\mathbf{Vec}_k^\omega(G)}(\mathfrak{g}) = 1$ for all $\mathfrak{g} \in \mathbf{Vec}_k(G)$.
- (c) The category \mathbf{TL} with its generators being the (co)evaluations is spherical. The dimension of its generating object \bullet is the morphism

$$\dim^{\mathbf{TL}}(\bullet) = \text{circle} \in \text{End}_{\mathbf{TL}}(\mathbb{1}).$$

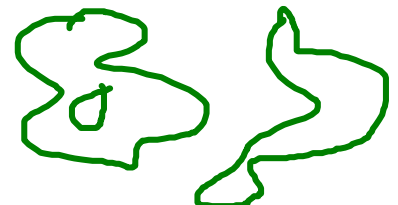

As a warning, being spherical or not depends on choices:

Example 4.59 For $G = \mathbb{Z}/3\mathbb{Z}$, take $\zeta \in \mathbb{C}$ to be a complex primitive third root of unity, and let

$$d(i) = \zeta^i, i \in \{0, 1, 2\}.$$

Then there is a choice of (co)evaluations on $\mathbf{Vec}_{\mathbb{C}}(\mathbb{Z}/3\mathbb{Z})$ given by

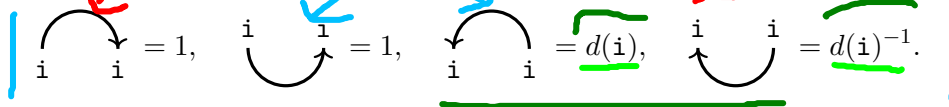

This gives

$$\bigcirc \rightarrow 1 = \zeta^2 \neq \zeta = 1 \leftarrow \bigcirc, \quad \bigcirc \rightarrow 2 = \zeta \neq \zeta^2 = 2 \leftarrow \bigcirc.$$

Thus, with this choice $\mathbf{Vec}_{\mathbb{C}}(\mathbb{Z}/3\mathbb{Z})$ is pivotal, but not spherical.

Remark 4.60 By definition and [Example 4.20](#) as well as [Example 4.59](#) we have

$$\left. \begin{aligned} \text{rigid} &\Leftarrow \text{pivotal} \Leftarrow \text{spherical}, \\ \text{rigid} &\not\Leftarrow \text{pivotal} \not\Leftarrow \text{spherical}. \end{aligned} \right\}$$

We now discuss the generalization of the well-known properties of traces of matrices.

Proposition 4.61 For any $\mathbf{C} \in \mathbf{PCat}$ the following hold.

(i) We have

$$\text{tr}^{\mathbf{C}}(f) = {}^{\mathbf{C}}\text{tr}(f) = f,$$

for all $f \in \text{End}_{\mathbf{C}}(\mathbb{1})$. In particular,

$$\dim^{\mathbf{C}}(\mathbb{1}) = {}^{\mathbf{C}}\dim(\mathbb{1}) = \text{id}_{\mathbb{1}}.$$

(ii) Traces are $\text{End}_{\mathbf{C}}(\mathbb{1})$ -linear, i.e.

$$\text{tr}^{\mathbf{C}}(f \cdot g) = f \cdot \text{tr}^{\mathbf{C}}(g), \quad \text{tr}^{\mathbf{C}}(g \cdot f) = \text{tr}^{\mathbf{C}}(g) \cdot f, \quad {}^{\mathbf{C}}\text{tr}(f \cdot g) = f \cdot {}^{\mathbf{C}}\text{tr}(g), \quad {}^{\mathbf{C}}\text{tr}(g \cdot f) = {}^{\mathbf{C}}\text{tr}(g) \cdot f,$$

for all $f \in \text{End}_{\mathbf{C}}(\mathbb{1})$ and $g \in \text{End}_{\mathbf{C}}(X)$.

(iii) Traces are cyclic, i.e.

$$\text{tr}^{\mathbf{C}}(gf) = \text{tr}^{\mathbf{C}}(fg), \quad {}^{\mathbf{C}}\text{tr}(gf) = {}^{\mathbf{C}}\text{tr}(fg),$$

for all $f \in \text{Hom}_{\mathbf{C}}(X, Y)$ and $g \in \text{Hom}_{\mathbf{C}}(Y, X)$.

(iv) We have

$$\text{tr}^{\mathbf{C}}(f) = {}^{\mathbf{C}}\text{tr}(f^*), \quad {}^{\mathbf{C}}\text{tr}(f) = \text{tr}^{\mathbf{C}}(f^*)$$

for all $f \in \text{End}_{\mathbf{C}}(X)$. In particular, for all $X \in \mathbf{C}$, we get

$$\dim^{\mathbf{C}}(X) = {}^{\mathbf{C}}\dim(X^*) = \dim^{\mathbf{C}}(X^{**}), \quad {}^{\mathbf{C}}\dim(X) = \dim^{\mathbf{C}}(X^*) = {}^{\mathbf{C}}\dim(X^{**}).$$

Proof. (i) and (ii). The short argument is that f is a floating bubble, cf. [Proposition 2.36](#).

(iii). By right-left symmetry, we only need to calculate

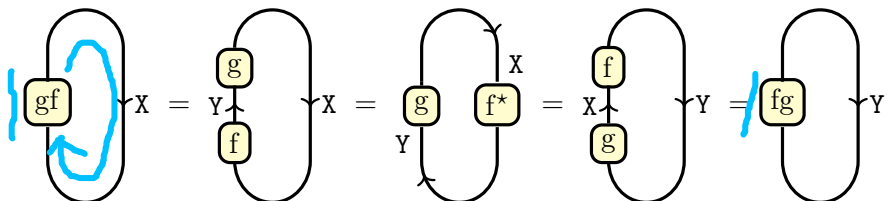

(iv). Sliding immediately gives

$$\begin{array}{c} \text{f} \\ \circlearrowleft \\ \text{X} \end{array} = \begin{array}{c} \text{X} \\ \circlearrowright \\ \text{f}^* \end{array},$$

which proves the claim by right-left symmetry. □

Lemma 4.62 For $F \in \text{Hom}_*(\mathbf{C}, \mathbf{D})$ and all $X \in \mathbf{C}$ and $f \in \text{End}_{\mathbf{C}}(X)$ we have

$$\begin{aligned} \text{tr}^{\mathbf{D}}(F(f)) &= F(\text{tr}^{\mathbf{C}}(f)), & \mathbf{D}\text{tr}(F(f)) &= F(\mathbf{C}\text{tr}(f)), \\ \dim^{\mathbf{D}}(F(X)) &= F(\dim^{\mathbf{C}}(X)), & \mathbf{D}\dim(F(X)) &= F(\mathbf{C}\dim(X)). \end{aligned}$$

Proof. Note that rigid functors preserve (co)evaluations. □

In words, rigid functors preserve traces and dimensions, which motivates:

Definition 4.63 $\mathbf{C}, \mathbf{D} \in \mathbf{PCat}$ are called equivalent as pivotal categories, if they are equivalent as rigid categories.

Example 4.64 Back to [Example 4.33](#): there are sign choices for $\text{Vec}_{\mathbb{C}}^{\omega}(\mathbb{Z}/2\mathbb{Z})$ such that:

$$\begin{aligned} \text{choice 1: } & \begin{array}{c} \curvearrowright \\ 1 \quad 1 \end{array} = 1, & \begin{array}{c} 1 \quad 1 \\ \curvearrowleft \end{array} = -1, & \begin{array}{c} \curvearrowleft \\ 1 \quad 1 \end{array} = -1, & \begin{array}{c} 1 \quad 1 \\ \curvearrowright \end{array} = 1, \\ \text{choice 2: } & \begin{array}{c} \curvearrowright \\ 1 \quad 1 \end{array} = 1, & \begin{array}{c} 1 \quad 1 \\ \curvearrowleft \end{array} = -1, & \begin{array}{c} \curvearrowleft \\ 1 \quad 1 \end{array} = 1, & \begin{array}{c} 1 \quad 1 \\ \curvearrowright \end{array} = -1. \end{aligned}$$

This gives

$$\text{choice 1: } \begin{array}{c} \circlearrowleft \\ 1 \end{array} = 1 = 1 \begin{array}{c} \circlearrowright \\ 1 \end{array}, \quad \text{choice 2: } \begin{array}{c} \circlearrowleft \\ 1 \end{array} = -1 = 1 \begin{array}{c} \circlearrowright \\ 1 \end{array}.$$

This shows, by [Lemma 4.62](#), that these choices do not give pivotal categories which are equivalent as pivotal categories.

4I. Algebras and coalgebras revisited. We conclude with (co)algebras in rigid categories, whose modules have a right-left symmetry:

Proposition 4.65 Let $A \in \mathbf{C}$ for $\mathbf{C} \in \mathbf{RCat}$ be an algebra.

- (i) For every $M \in \text{Mod}_{\mathbf{C}}(A)$ its right dual M^* has the structure of a left A module.
- (ii) For every $N \in (A)\text{Mod}_{\mathbf{C}}$ its left dual *N has the structure of a right A module.

Similarly for coalgebras.

Proof. By symmetry, it suffices to prove (i).

(i). We define a left action on M^* via

$$\begin{array}{c} M^* \\ \uparrow \\ A \end{array} \begin{array}{c} M^* \\ \uparrow \\ A \end{array} = \begin{array}{c} M^* \\ \uparrow \\ \text{ev} \\ \uparrow \\ N \\ \uparrow \\ \text{coev} \\ \uparrow \\ A \end{array} \begin{array}{c} M^* \\ \uparrow \\ A \end{array}.$$



To show that this satisfies associativity and unitality is an easy zigzag argument. □

Thus:

Proposition 4.66 *Let $A \in \mathbf{C}$ for $\mathbf{C} \in \mathbf{PCat}$ be an algebra. Then, for every $M \in \mathbf{Mod}_{\mathbf{C}}(A)$ its dual M^* has the structure of a right and left A module. In particular, M itself has the structure of a left A module. Similarly for coalgebras. □*

4J. Exercises.

Exercise 4.67 Prove Lemma 4.15.

Exercise 4.68 Show that Theorem 4.16 implies that the functors

$$X \otimes -: \mathbf{C} \rightarrow \mathbf{C}, \quad - \otimes X: \mathbf{C} \rightarrow \mathbf{C}$$

have duals (a.k.a. adjoints) given by

$$(X \otimes -)^* \cong X^* \otimes -, \quad *(X \otimes -) \cong *X \otimes -, \quad (- \otimes X)^* \cong - \otimes *X, \quad *(- \otimes X) \cong - \otimes X^*,$$

assuming the existence of duals of $X \in \mathbf{C}$, where $\mathbf{C} \in \mathbf{MCat}$, of course.

Exercise 4.69 Show that $\mathbf{Vec}_k(M) \in \mathbf{RCat}$ if and only if M is a group.

Exercise 4.70 Show that \mathbf{Vec}_k is not rigid.

Exercise 4.71 Verify the claims in Example 4.59.

5. BRAIDED CATEGORIES – DEFINITIONS, EXAMPLES AND GRAPHICAL CALCULUS

Recall that the difference between 1Cob and 1Tan was a choice of embedding. So how can we distinguish between these two categories using categorical algebra, i.e.:

What categorical framework can detect embeddings?

5A. **A word about conventions.** This section is all about crossings.

Convention 5.1 We will have over- and undercrossings, which are algebraic and not topological in nature. Our diagrammatic conventions for these are

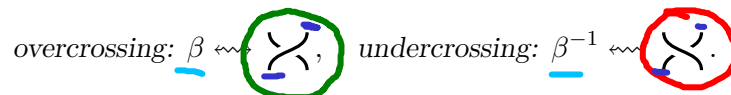

These will come in various incarnations, e.g. with orientations, and our preferred choice will be to use overcrossings, and the undercrossings will be the inverses of the overcrossings.

Convention 5.2 We use the same conventions as in Convention 4.2 for the various choices involved in the notions which we will see in this section. Moreover, and also as before, since we will use diagrammatics most of the time we usually omit the associators and unitors.

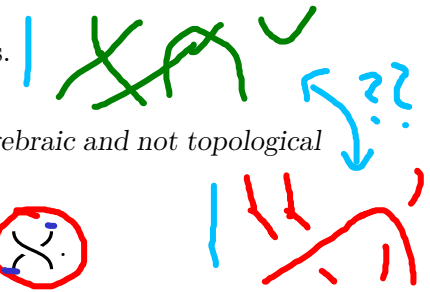

Convention 5.3 Our terminology "taking mirrors" includes also crossing reversals of all displayed crossings, e.g.

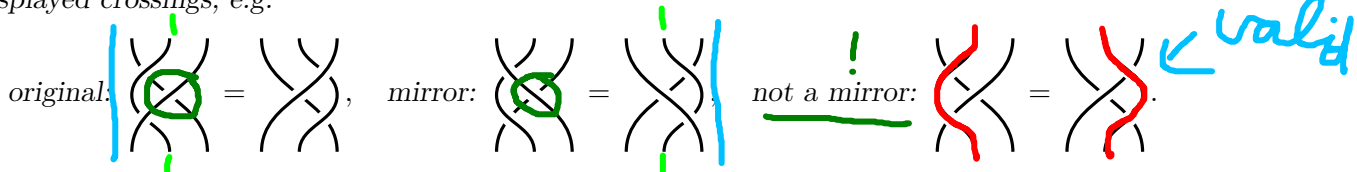

All of these are valid relations, but the right equation is not a mirror of the left equation.

5B. **Braided categories.** First, the main definition of this section:

Definition 5.4 A braided category (\mathbf{C}, β) consists of

- a category $\mathbf{C} \in \mathbf{MCat}$;
- a collection of natural isomorphisms

(5-1) $\beta_{X,Y}: XY \xrightarrow{\cong} YX,$

for all $X, Y \in \mathbf{C}$, called braiding;

such that

(i) the braided \square equalities hold, i.e. we have commuting diagrams

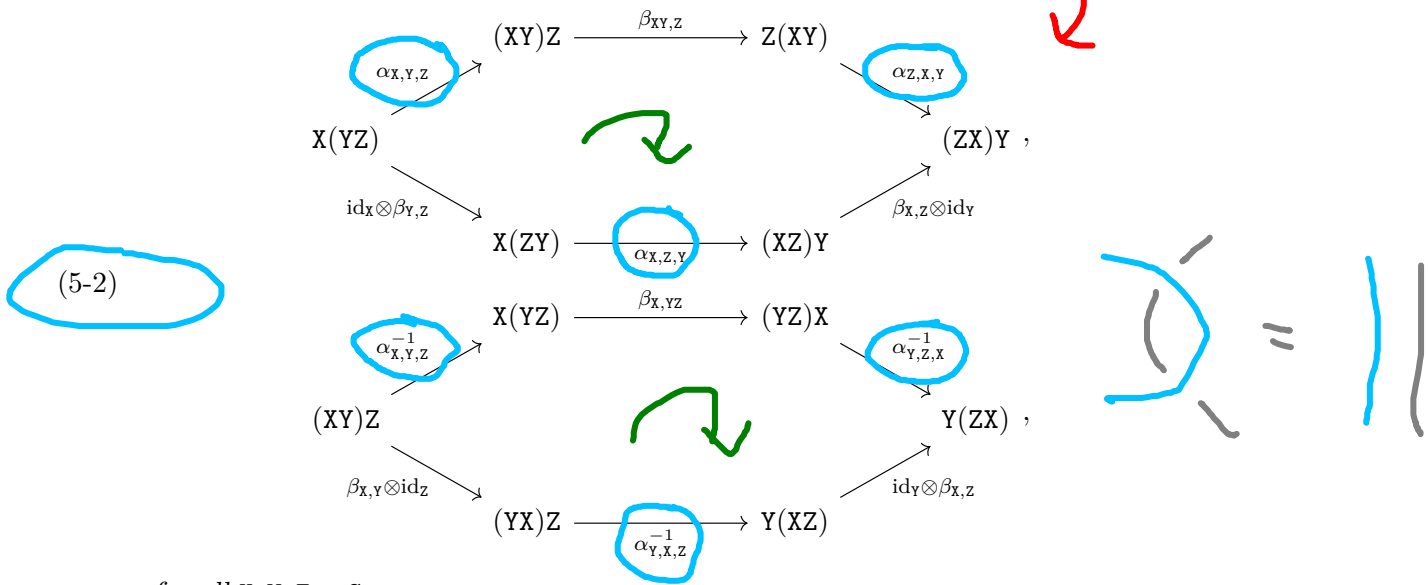

for all $X, Y, Z \in \mathbf{C}$.

Remark 5.5 Similarly as in Remark 2.5, there is a hidden braided \square equality:

(5-3)
$$\begin{array}{ccc} ZX & \xrightarrow{g \circ f} & AY \\ \beta_{X,Z} \uparrow & & \uparrow \beta_{Y,A} \\ XZ & \xrightarrow{f \circ g} & YA \end{array}$$

which holds for all for all $X, Y, Z, A \in \mathbf{C}$ and all $(f: X \rightarrow Y), (g: Z \rightarrow A) \in \mathbf{C}$.

Lemma 5.6 In any braided category \mathbf{C} we have the Reidemeister 2 moves, i.e. for all $X, Y \in \mathbf{C}$ there exist a natural isomorphism $\beta_{Y,X}^{-1}: YX \xrightarrow{\cong} XY$ such that

(5-4) $\beta_{Y,X}^{-1} \beta_{X,Y} = \text{id}_{XY}, \quad \beta_{X,Y} \beta_{Y,X}^{-1} = \text{id}_{YX} \quad (\Leftrightarrow \beta_{Y,X}^{-1} \beta_{X,Y} = \text{id}_{XY} = \beta_{Y,X} \beta_{X,Y}^{-1})$

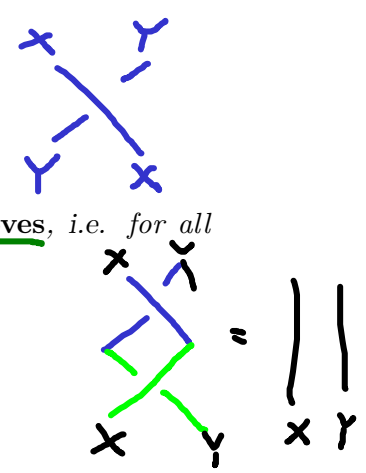

Proof. (5-1) implies that $\beta_{X,Y}$ has an inverse, and we denote by $\beta_{Y,X}^{-1}$. Note that $\beta_{Y,X}^{-1}$ is natural in X and Y because $\beta_{X,Y}$ is. \square

Lemma 5.7 In any braided category \mathbf{C} we have the Reidemeister 3 move, i.e.

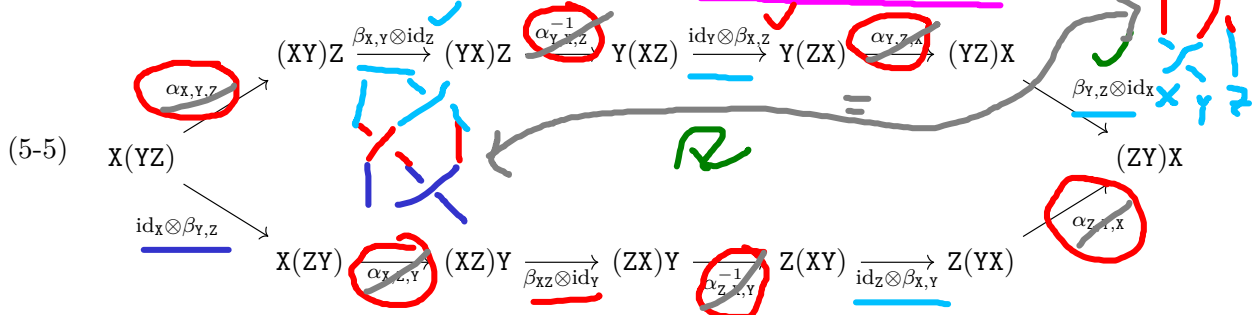

commutes for all $X, Y, Z \in \mathbf{C}$.

Proof. The diagrammatic proof is easy as we will see in Lemma 5.14 below, so we are done after strictification, cf. Theorem 5.24 stated below. \square

Definition 5.8 A braided category \mathbf{C} is called symmetric, if $\beta_{Y,X}\beta_{X,Y} = \text{id}_{XY}$ holds for all $X, Y \in \mathbf{C}$.

Example 5.9 The motivating examples are the usual ones:

- (a) The category Set with $\otimes = \times$ and $\mathbb{1} = \{\bullet\}$ can be endowed with a symmetric braiding by using the swap map

$$\tau_{X,Y}: XY \rightarrow YX, (x, y) \mapsto (y, x).$$

- (b) Similarly, Vec_k or fdVec_k with $\otimes = \otimes_k$ and $\mathbb{1} = k$ can be endowed with a symmetric braiding by also using (the k linear incarnation of) the swap map.

As usual with choices, they are often not unique:

$$\leftarrow \text{Vec}(G)$$

$$\begin{matrix} 1 \otimes 1 \\ \uparrow \\ 1 \otimes 1 \end{matrix}$$

Example 5.10 The category $\text{Vec}_{\mathbb{C}}(\mathbb{Z}/2\mathbb{Z})$ with its standard monoidal structure can be endowed with two braidings (note that braidings $\beta_{i,j} \in \text{End}_{\text{Vec}_{\mathbb{C}}(\mathbb{Z}/2\mathbb{Z})}(ij) \cong \mathbb{C}$ are scalars):

- by using the so-called standard braiding $\beta_{1,1}^{st} = 1$;
- by using the so-called super braiding $\beta_{1,1}^{su} = -1$.

$$\leftarrow (-1)^2 = 1$$

Proposition 5.11 For any braided category \mathbf{C} its Grothendieck classes $K_0(\mathbf{C})$ form a commutative monoid with multiplication and unit

$$[X][Y] = [XY] = [Y][X], \quad 1 = [\mathbb{1}].$$

Proof. The only thing we need to observe in addition to Proposition 2.10 is that the existence of the braiding gives $[X][Y] = [Y][X]$ because we have (5-1). \square

Example 5.12 The category $\text{Vec}_k(G)$ with its standard monoidal structure can only be braided if G is abelian. To see this observe that $K_0(\text{Vec}_k(G)) \cong G$ as groups, and thus Proposition 5.11 applies.

5C. **Feynman diagrams for braided categories.** Example 5.15 already suggests the following diagrammatic conventions. We take the ones for monoidal categories, see e.g. (2-7), together with diagrammatic rules for braidings:

(5-6)

where (5-1) implies that $\beta_{X,Y}$ has an inverse. Being inverses gives the **Reidemeister 2 moves**, i.e. the diagrammatic analogs of (5-4):

(5-7)

hold for all $X, Y \in \mathbf{C}$.

Remark 5.13 We usually, following history, use the right-hand side in (5-7) as the Reidemeister 2 moves. Further, beware that $\beta_{Y,X}^{-1}$ is the inverse of $\beta_{X,Y}$ and not $\beta_{X,Y}^{-1}$.

The diagrammatic incarnations of the braided \triangleleft and \square equalities in (5-2) and (5-3) are

(5-8)

Similarly as in Lemma 4.49, we call the right relation **sliding**. We also have the **Reidemeister 3 move**, i.e. the diagrammatic analog of (5-5):

Lemma 5.14 In any braided category \mathbf{C} we have the **Reidemeister 3 move**, i.e.

(5-9)

holds for all $X, Y, Z \in \mathbf{C}$.

Proof. We use (5-8) for a specific choice, i.e.

$$X = XY, Y = YX, Z = A, Y = A, \quad \begin{array}{c} YX \\ | \\ \boxed{f} \\ | \\ XY \end{array} = \begin{array}{c} Y \quad X \\ \diagdown \quad \diagup \\ X \quad Y \end{array}, \quad \begin{array}{c} Z \\ | \\ \boxed{g} \\ | \\ Z \end{array} = \begin{array}{c} Z \\ | \\ Z \end{array},$$

with the right-hand sides of all equations being the choices. This shows (5-9). □

In the symmetric braided case we have $\beta_{Y,X}\beta_{X,Y} = \text{id}_{XY}$, which implies that

$$\beta_{X,Y} = \beta_{X,Y}^{-1} \iff \begin{array}{c} Y \ X \\ \diagdown \ / \\ X \ Y \end{array} = \begin{array}{c} Y \ X \\ \diagup \ \diagdown \\ X \ Y \end{array} = \begin{array}{c} Y \ X \\ \diagdown \ / \\ X \ Y \end{array},$$

where the right-hand side is thus an appropriate shorthand notation. Hence, in symmetric braided categories the Reidemeister moves (5-7) and (5-9) then become

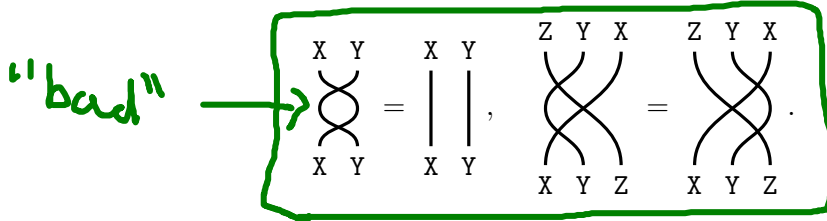

Example 5.15 Again, we have the notions of being “free as an XYZ”:

- (a) The free braided category generated by one object \bullet is **qSym** from Example 3.29. This category is important, so let us be completely explicit. We let $\mathbf{qSym} = \langle \mathbf{S}, \mathbf{T} \mid \mathbf{R} \rangle$ with

(5-10) $\mathbf{S} : \bullet, \quad \mathbf{T} : \begin{array}{c} \diagdown \ / \\ \diagup \ \diagdown \end{array} : \bullet^2 \rightarrow \bullet^2, \quad \mathbf{R} : \begin{array}{c} \diagdown \ / \\ \diagup \ \diagdown \end{array} = \begin{array}{c} \diagup \ \diagdown \\ \diagdown \ / \end{array} = \begin{array}{c} \diagdown \ / \\ \diagup \ \diagdown \end{array}, \quad \begin{array}{c} \diagdown \ / \\ \diagup \ \diagdown \end{array} = \begin{array}{c} \diagup \ \diagdown \\ \diagdown \ / \end{array}.$ ← R1 only

(We do not take mirrors.) R2 R3 ↗ X=X=X

- (b) The free symmetric braided category generated by one object \bullet is **Sym** from Example 3.21.

To see that this we observe that for one object (5-7) and (5-9) are equivalent to the braided \square and \square equalities in (5-2) and (5-3).

Remark 5.16 Note that **qSym** has only overcrossings appearing in its definition. The undercrossings come into the game via invertibility. In particular,

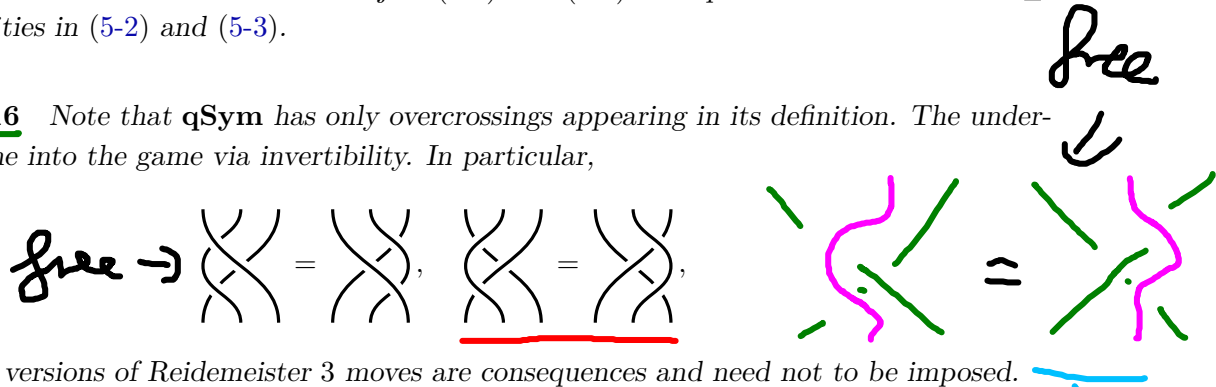

The formal rule for braided Feynman diagrams is thus:

(5-11) “Two diagrams are equivalent if they are related by scaling, by a planar isotopy, or braided \square and \square equalities (5-8).”

Theorem 5.17 The graphical calculus is consistent, i.e. two morphisms are equal if and only if their diagrams are related by (5-11). ✓

Proof. The statement of the theorem just summarizes the discussion above: we have the Reidemeister 2 and 3 moves for strands, see (5-7) and (5-9), and we can slide coupons (5-8). □

5D. **Braided functors.** As usual, we want the notion of functors between braided categories. To this end, recall that a monoidal functor $(F, \xi, \xi_{\mathbb{1}})$ was a functor with an additional choice of data, cf. [Definition 2.20](#). In contrast, being braided is a property:

Definition 5.18 A functor $F \in \mathbf{Hom}_{\otimes}(\mathbf{C}, \mathbf{D})$ between braided categories is called **braided** if

$$\begin{array}{ccc} F(\mathbf{X})F(\mathbf{Y}) & \xrightarrow{\beta_{F(\mathbf{X}), F(\mathbf{Y})}} & F(\mathbf{Y})F(\mathbf{X}) \\ \xi_{\mathbf{X}, \mathbf{Y}} \downarrow & & \downarrow \xi_{\mathbf{Y}, \mathbf{X}} \\ F(\mathbf{XY}) & \xrightarrow{F(\beta_{\mathbf{X}, \mathbf{Y}})} & F(\mathbf{YX}) \end{array} \quad ,$$

commutes for all $\mathbf{X}, \mathbf{Y} \in \mathbf{C}$.

We proceed as usual:

Lemma 5.19 The identity functor on a braided category is braided. Moreover, if F and G are braided functors, then so is GF . □

Example 5.20 We get the category of braided categories \mathbf{BCat} and the category of braided functors $\mathbf{Hom}_{\beta}(\mathbf{C}, \mathbf{D})$, whose natural transformations are monoidal natural transformations.

Definition 5.21 $\mathbf{C}, \mathbf{D} \in \mathbf{BCat}$ are called equivalent as braided categories, denoted by $\mathbf{C} \simeq_{\beta} \mathbf{D}$, if there exists an equivalence $F \in \mathbf{Hom}_{\beta}(\mathbf{C}, \mathbf{D})$.

Example 5.22 We also have the category of braided pivotal categories \mathbf{BPCat} and the notion of equivalence for these is denoted by $\mathbf{C} \simeq_{\beta, \star} \mathbf{D}$. These equivalences use braided rigid functors which also form the category of braided rigid functors $\mathbf{Hom}_{\beta, \star}(\mathbf{C}, \mathbf{D})$.

Definition 5.23 A category (\mathbf{C}, β) is called strict, if it is strict as a monoidal category.

As usual:

Theorem 5.24 For any braided category \mathbf{C} there exists a strict braided category \mathbf{C}^{st} which is braided equivalent to \mathbf{C} , i.e. $\mathbf{C} \simeq_{\beta} \mathbf{C}^{st}$. ✓

Proof. This is an almost immediate consequence of [Theorem 2.32](#), see [[JS93](#), Theorem 2.5] for a detailed argument. □

5E. **Classifying braidings.** *Classifying braidings*, meaning finding all possible braidings on $\mathbf{C} \in \mathbf{MCat}$ up to braided equivalence, is very difficult. So [Theorem 5.26](#) below is quite remarkable. Before we state it we need some preparation.

Lemma 5.25 Let G be abelian. Then the braidings on $\mathbf{Vec}_{\mathbb{k}}^{\omega}(G)$ (with its usual monoidal structure) are classified by twisted group homomorphisms $\beta: G \times G \rightarrow \mathbb{k}^*$, i.e. maps satisfying

$$(5-12) \quad \begin{aligned} \omega(k, i, j)\beta(ij, k)\omega(i, j, k) &= \beta(i, k)\omega(i, k, j)\beta(j, k) \\ \omega(j, k, i)^{-1}\beta(i, jk)\omega(i, j, k)^{-1} &= \beta(i, k)\omega(j, i, k)^{-1}\beta(i, j). \end{aligned}$$

Hard

In particular, if ω is trivial, then braidings are classified by group homomorphisms $\beta: G \times G \rightarrow \mathbb{k}^*$.

Such maps as in Lemma 5.25 are also known as **(twisted) bicharacters**. The above thus says that every braiding has an associated twisted bicharacter, which we denote by the same symbol.

Proof. By comparing (5-2) and (5-12) we see that each such β can be used to define a braiding, and vice versa. \square

A general philosophy, which we already have seen in Remark 2.27, is that “Some cohomology theory should measure the obstruction of two braiding to be equivalent.”. In fact, it is easy to see that functions satisfying (5-12) for fixed ω form an abelian group $Z_\omega^3(G, \mathbb{k}^*)$, which are the 3 cocycles of a cohomology group $H_\omega^3(G, \mathbb{k}^*)$, see e.g. [EGNO15, Section 8.4] for the definition. Indeed:

Theorem 5.26 Let G be abelian and fix a 3 cocycle ω . Then $(\mathbf{Vec}_k^\omega(G), \beta) \cong_\beta (\mathbf{Vec}_k^\omega(G), \beta')$ if and only if β and β' are cohomologically equivalent.

Proof. In the end this is just a careful, but demanding, check of the involved definitions and commuting diagrams. Details are discussed in [EGNO15, Section 8.4]. \square

Example 5.27 Via Theorem 5.26 we get the following, always using the standard monoidal structures.

(a) The $G = 1$ case of Theorem 5.26 implies that \mathbf{fdVec}_k allows only one braiding if one fixes its standard monoidal structure since one can check that $H_1^3(1, \mathbb{k}^*) \cong 1$. See also Example 6.23 later on.

(b) For $G = \mathbb{Z}/2\mathbb{Z}$ and non-trivial ω , has only two braidings:

$$\beta_{0,0}^\pm = \beta_{0,1}^\pm = \beta_{1,0}^\pm = 1, \quad \beta_{1,1}^\pm = \pm i \in \mathbb{C}.$$

The crucial calculation hereby is

$$\begin{aligned} \omega(1, 1, 1)\beta(11, 1)\omega(1, 1, 1) &= (-1)1(-1) = \beta(1, 1)(-1)\beta(1, 1) = \beta(1, 1)\omega(1, 1, 1)\beta(1, 1) \\ &\Rightarrow \beta(1, 1)^2 = -1. \end{aligned}$$

It turns out that these are equivalent, i.e. $H_\omega^3(\mathbb{Z}/2\mathbb{Z}, \mathbb{C}^*) \cong 1$, and has only one (non-trivial) braiding up to equivalence.

(c) For $G = \mathbb{Z}/2\mathbb{Z}$ and trivial ω , we find precisely two possible solutions to (5-12) and recover Example 5.10.(a) and (b), since $H_1^3(\mathbb{Z}/2\mathbb{Z}, \mathbb{C}^*) \cong \mathbb{Z}/2\mathbb{Z}$.

5F. **The Reidemeister calculus.** Recall that Theorem 3.26 identifies $\mathbf{1Cob}$ algebraically. We are now ready to state the analogs for $\mathbf{1Tan}$ and $\mathbf{1State}$.

But first things first, let us be clear about the definitions of \mathbf{qBr} and \mathbf{oqBr} :

Example 5.28 The (generic) quantum Brauer category \mathbf{qBr} is the braided pivotal category generated by one self-dual object \square with relations

$$(5-13) \quad R: \begin{array}{c} \text{cup} \\ \text{cap} \end{array} = \begin{array}{c} \text{cup} \\ \text{cap} \end{array}, \quad \begin{array}{c} \text{cup} \\ \text{cap} \end{array} = \begin{array}{c} \text{cup} \\ \text{cap} \end{array}$$

Handwritten notes:
 $R^{-1} = \text{Kirch}$
 $S = \cap$
 $\text{cup} = \text{cup}$
 $\text{cap} = \text{cap}$

including mirrors, with structure maps

$$\begin{matrix} \diagdown \diagup \\ \diagup \diagdown \end{matrix} : \bullet \bullet \rightarrow \bullet \bullet, \quad \frown : \bullet \bullet \rightarrow \mathbb{1}, \quad \smile : \mathbb{1} \rightarrow \bullet \bullet.$$

Example 5.29 The (generic) oriented quantum Brauer category **oqBr** is the braided pivotal category generated by one object \bullet with relations

$$(5-14) \quad \left| \begin{matrix} \text{R: } \bigcirc = \frown, \quad \begin{matrix} \uparrow \\ \downarrow \end{matrix} \text{ } \begin{matrix} \uparrow \\ \downarrow \end{matrix} = \begin{matrix} \uparrow \\ \downarrow \end{matrix} \text{ } \begin{matrix} \uparrow \\ \downarrow \end{matrix} \end{matrix} \right|$$

including mirrors, with structure maps

$$\begin{matrix} \uparrow \\ \downarrow \end{matrix} : \bullet \bullet \rightarrow \bullet \bullet, \quad \frown : \bullet \bullet^* \rightarrow \mathbb{1}, \quad \smile : (\bullet^*) \bullet \rightarrow \mathbb{1}, \quad \smile : \mathbb{1} \rightarrow \bullet \bullet^*, \quad \smile : \mathbb{1} \rightarrow (\bullet^*) \bullet.$$

The category **qBr** is also called *BMW (Birman–Murakami–Wenzl) category* in the literature, while **oqBr** is sometimes called *quantum walled Brauer category*.

Remark 5.30 Note that (5-13) and (5-14) are not all defining relations as some are hidden in the phrase “generated as an XYZ”. For example,

$$\begin{matrix} \diagdown \diagup \\ \diagup \diagdown \end{matrix} = \begin{matrix} \diagup \diagdown \\ \diagdown \diagup \end{matrix}$$

holds in both categories (with upward orientations for **oqBr**) and is part of being braided.

Clearly, **1Tan** and **1State** are braided and pivotal with the evident structures. Recall also that we have the Reidemeister theorem:

(5-15) “Two (oriented) tangles in three space are isotopic if their projections (also known as tangle diagrams) are related by planar isotopies and Reidemeister moves 1-3, see (5-16).”

The topological Reidemeister 1, 2 and 3 moves are all versions (not just mirrors) of

$$(5-16) \quad \left[\begin{matrix} 1: \begin{matrix} \uparrow \\ \downarrow \end{matrix} \text{ } \begin{matrix} \uparrow \\ \downarrow \end{matrix} = \begin{matrix} \uparrow \\ \downarrow \end{matrix} \text{ } \begin{matrix} \uparrow \\ \downarrow \end{matrix} \\ 2: \begin{matrix} \diagdown \diagup \\ \diagup \diagdown \end{matrix} = \begin{matrix} \diagup \diagdown \\ \diagdown \diagup \end{matrix} \\ 3: \begin{matrix} \diagdown \diagup \\ \diagup \diagdown \end{matrix} = \begin{matrix} \diagup \diagdown \\ \diagdown \diagup \end{matrix} \end{matrix} \right]$$

Remark 5.31 Traditionally the topological Reidemeister 1 moves are usually illustrated vertically as in (5-16), while their analogs in the Brauer calculus are traditionally sideways, see e.g. (5-14), as it is a shorter composition of the generators. By (4-15), these are the same data, and we will call the both the Reidemeister 1 moves.

In our language, the categorical version of the Reidemeister theorem (5-15) is:

Theorem 5.32 There exist braided rigid functors

$$\text{qR: } \underline{\text{qBr}} \xrightarrow{\sim} \underline{\text{1Tan}}, \quad \bullet \mapsto \bullet, \quad \begin{matrix} \diagdown \diagup \\ \diagup \diagdown \end{matrix} \mapsto \begin{matrix} \diagdown \diagup \\ \diagup \diagdown \end{matrix}, \quad \frown \mapsto \frown, \quad \smile \mapsto \smile,$$

$$\text{oqR: } \underline{\text{oqBr}} \xrightarrow{\sim} \underline{\text{1State}}, \quad \bullet \mapsto \bullet, \quad \begin{matrix} \uparrow \\ \downarrow \end{matrix} \mapsto \begin{matrix} \uparrow \\ \downarrow \end{matrix}, \quad \frown \mapsto \frown, \quad \smile \mapsto \smile, \quad \smile \mapsto \smile, \quad \smile \mapsto \smile, \quad \smile \mapsto \smile.$$

Both functors are dense and fully faithful, thus, $\text{qBr} \simeq_{\beta, \star} \text{1Tan}$ and $\text{oqBr} \simeq_{\beta, \star} \text{1State}$.

hard!

Proof. Let us sketch a proof. Exactly as for [Theorem 3.26](#), the main problem is to prove that these functors are faithful. To show faithfulness one needs to identify the generating relations of, say, **1Tan**. In words, one needs to identify what “isotopies of tangles” means for their projections.

To this end, the first step is to show that any tangle, appropriately defined, has a piecewise linear Morse presentation. A Morse presentation was already needed for the proof of fullness and has exactly the same meaning as in (3-4), while piecewise linear basically is

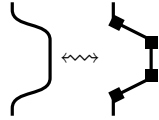

Here the **■** denotes the boundary points of the piecewise linear parts. (Note that all pictures in this proof are meant to represent topological objects.)

Then one needs to identify what isotopies are on these piecewise linear presentations and one gets the notion of Δ *equivalence* \sim_{Δ} via Δ *moves*:

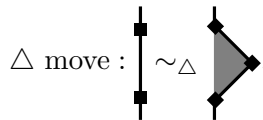

Here the triangle is not part of the link, but rather an illustration that no other strand is allowed to pass through it while performing the Δ move. In words, two piecewise linear tangles are isotopic if and only if they are Δ equivalent.

The first consequence of Δ equivalence to notice is subdivision, *i.e.*

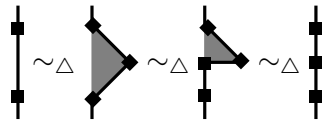

Thus, it remains to analyze how Δ moves generically and locally project. In fact, the main upshot is that there are only finitely many possibilities one needs to check and one ends with precisely all possible versions (not just mirrors) of the Reidemeister moves *e.g.*:

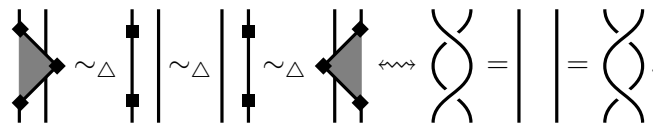

This established the Reidemeister theorem that two tangles are isotopic (in three space) if and only if their projections are related by planar isotopies and Reidemeister moves.

The final thing to check is that **oqBr** has enough relations to obtain all versions of the Reidemeister moves as well as all possible planar isotopies. Again, this is non-trivial as we *e.g.* imposed only certain types of Reidemeister relations such as only upwards oriented Reidemeister 2 moves. \square

5G. **Twists.** Recall that the Reidemeister 2 and 3 moves (5-7) and (5-9) are consequences of the axioms of a braided category. For a braided pivotal category a good question would be whether the Reidemeister 1 moves as in (5-16) follows from the combined axioms. Let us address this question.

braided $\not\Rightarrow$ R1

Definition 5.33 For $X \in \mathbf{C}$ with $\mathbf{C} \in \mathbf{BPCat}$ the right t_X and left t^X twists are defined via

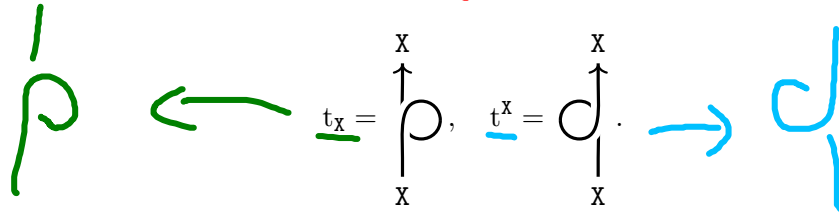

There are three possible version of Reidemeister 1 moves. To explain them fix $X \in \mathbf{C}$ for $\mathbf{C} \in \mathbf{BPCat}$. First, the (classical) Reidemeister 1 moves are

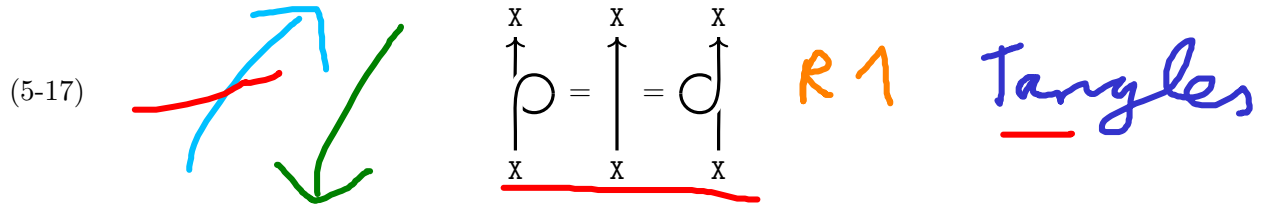

Second, the ribbon equation is

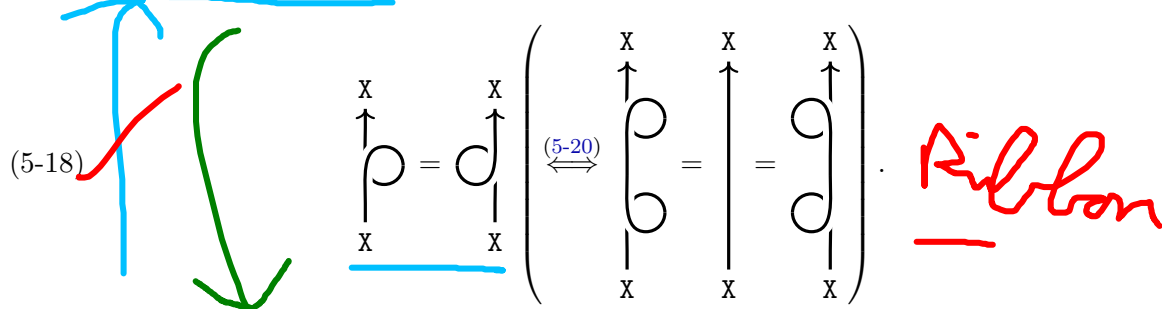

Finally, the framed Reidemeister 1 moves are

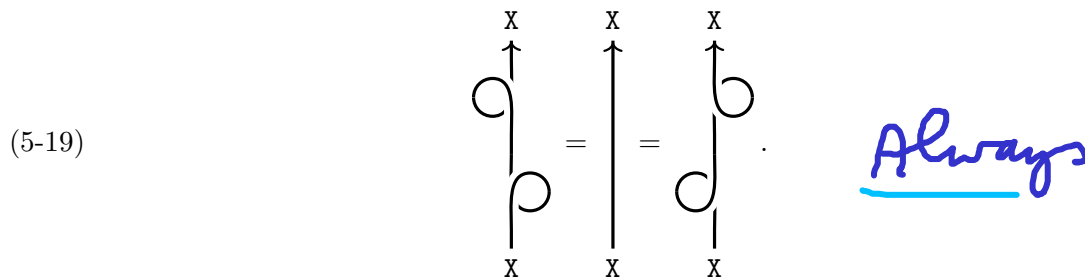

Example 5.34 Clearly, (5-17) \Rightarrow (5-18) \Rightarrow (5-19). But:

(a) In \mathbf{fdVec}_k with its standard monoidal structure, pairing and braiding we have

$$t_X: X \rightarrow X, x_j \mapsto \sum_{i=1}^n x_j \otimes x_i \otimes x_i^* \mapsto \sum_{i=1}^n x_i \otimes x_j \otimes x_i^* \mapsto x_j,$$

$$t^X: X \rightarrow X, x_j \mapsto \sum_{i=1}^n x_i^* \otimes x_i \otimes x_j \mapsto \sum_{i=1}^n x_i^* \otimes x_j \otimes x_i \mapsto x_j.$$

R1 ✓

(Recall hereby our notation from [Example 4.11](#).) Thus, (5-17) holds.

(b) For $\mathbf{Vec}_{\mathbb{C}}(\mathbb{Z}/2\mathbb{Z})$ we have discussed two pivotal structures in [Example 4.64](#). If we take the second pivotal structure therein together with the trivial braiding, then

$$t_1: 1 \rightarrow 1, t_1 = -1, \quad t^1: 1 \rightarrow 1, t^1 = -1.$$

Thus, (5-19) and (5-18) hold, but (5-17) fails to hold.



(c) For $\text{Vec}_{\mathbb{C}}(\mathbb{Z}/3\mathbb{Z})$ and $\zeta \in \mathbb{C}$ a primitive third root of unity we have discussed a pivotal structure in [Example 4.59](#). Taking this structure together with the trivial braiding we get

$$t_1: 1 \rightarrow 1, t_1 = \zeta^2, \quad t_2: 2 \rightarrow 2, t_2 = \zeta,$$

$$t^1: 1 \rightarrow 1, t^1 = \zeta, \quad t^2: 2 \rightarrow 2, t^2 = \zeta^2.$$

Thus, [\(5-19\)](#) holds, but neither do ~~[\(5-17\)](#)~~ or ~~[\(5-18\)](#)~~.

Lemma 5.35 Fix $X \in \mathbf{C}$ for $\mathbf{C} \in \mathbf{BPCat}$.

(i) The right and left twists are invertible with inverses

(5-20)
$$(t_X)^{-1} = \begin{array}{c} X \\ \uparrow \\ \text{---} \\ \downarrow \\ X \end{array}, \quad (t^X)^{-1} = \begin{array}{c} X \\ \uparrow \\ \text{---} \\ \downarrow \\ X \end{array}.$$

(ii) We have sliding, i.e.

$$\begin{array}{c} \text{---} \\ \downarrow \\ X \end{array} \begin{array}{c} \text{---} \\ \downarrow \\ X \end{array} = \begin{array}{c} \text{---} \\ \downarrow \\ X \end{array} \begin{array}{c} \text{---} \\ \downarrow \\ X \end{array},$$

including mirrors.

(iii) With respect to duality we have

$$(t_X)^* = t^{X^*} = \begin{array}{c} X \\ \downarrow \\ \text{---} \\ \downarrow \\ X \end{array}, \quad (t^X)^* = t_{X^*} = \begin{array}{c} X \\ \downarrow \\ \text{---} \\ \downarrow \\ X \end{array}.$$

(iv) All of the above maps are natural, i.e. they assemble into natural transformations.

Proof. (i) See [[TV17](#), Lemma 3.2].

(ii). Using (i) and Reidemeister moves we get

$$\begin{array}{c} \text{---} \\ \downarrow \\ X \end{array} \begin{array}{c} \text{---} \\ \downarrow \\ X \end{array} = \begin{array}{c} \text{---} \\ \downarrow \\ X \end{array} \begin{array}{c} \text{---} \\ \downarrow \\ X \end{array} = \begin{array}{c} \text{---} \\ \downarrow \\ X \end{array} \begin{array}{c} \text{---} \\ \downarrow \\ X \end{array}.$$

(iii). This is a direct application of sliding (ii) and zigzag.

(iv). The naturality of the twists is a direct consequence of the naturality of the braiding and the dualities. \square

[Lemma 5.35](#) immediately implies:

Proposition 5.36 For $\mathbf{C} \in \mathbf{BPCat}$ and all $X \in \mathbf{C}$ the equation (5-19) holds. \square

Remark 5.37 By definition and [Example 5.34](#) we have

Framed Reidemeister 1 \Leftarrow ribbon equation \Leftarrow Reidemeister 1,
 framed Reidemeister 1 $\not\Leftarrow$ ribbon equation $\not\Leftarrow$ Reidemeister 1.

Example 5.38 The (generic) oriented framed quantum Brauer category ofqBr is the braided pivotal category generated by one object \bullet with relations

(5-21) $R: \begin{array}{c} \uparrow \\ \downarrow \end{array} \begin{array}{c} \curvearrowright \\ \curvearrowleft \end{array} = \begin{array}{c} \curvearrowright \\ \curvearrowleft \end{array} \begin{array}{c} \uparrow \\ \downarrow \end{array},$ 

including mirrors, with structure maps

$$\begin{array}{c} \uparrow \\ \downarrow \end{array}: \bullet\bullet \rightarrow \bullet\bullet, \quad \curvearrowright: \bullet\bullet^* \rightarrow \mathbb{1}, \quad \curvearrowleft: (\bullet^*)\bullet \rightarrow \mathbb{1}, \quad \smile: \mathbb{1} \rightarrow \bullet\bullet^*, \quad \frown: \mathbb{1} \rightarrow (\bullet^*)\bullet.$$

Note that [Proposition 5.36](#) implies that [\(5-19\)](#) holds in ofqBr. In fact, a non-trivial argument shows that ofqBr is the free braided pivotal category generated by one object.

Example 5.39 Without further definition, there are of course also a non-oriented fqBr, non-quantum ofBr and only framed fBr versions of ofBr.

5H. Ribbon categories. We have seen that the Reidemeister 1 moves [\(5-17\)](#) are motivated from the topology of tangles in three space. As we will see, the framed Reidemeister 1 moves [\(5-19\)](#) are also related to topology, but only in the form as in [\(5-18\)](#). This motivates:

Definition 5.40 A category $\mathbf{C} \in \mathbf{BPCat}$ is called ribbon if [\(5-18\)](#) holds for all $X \in \mathbf{C}$.

Example 5.41 The two categories in [Example 5.34](#).(a) and (b) are ribbon, while [Example 5.34](#).(c) is not. It will also follow from [Lemma 5.43](#) that the non-spherical category from [Example 5.34](#).(c) can not be ribbon.

Example 5.42 Note that being ribbon is a property and not a structure. So we can let the category of ribbon categories RiCat be the corresponding full subcategory of \mathbf{BPCat} .

Lemma 5.43 Let $\mathbf{C} \in \mathbf{RiCat}$. Then \mathbf{C} is spherical.

Nice fact

Proof. Using the Reidemeister calculus and sliding this is the calculation

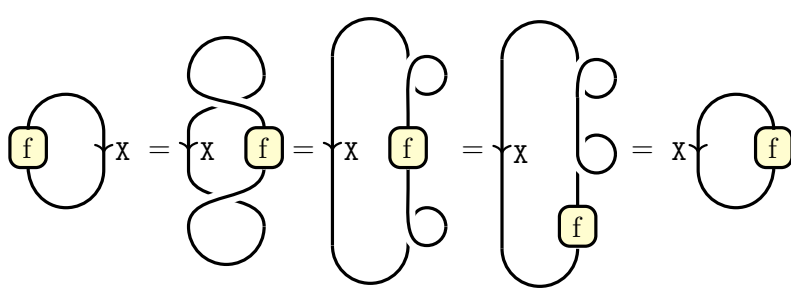

where the last step uses [\(5-18\)](#). \square

Remark 5.44 The name ribbon comes from the following. If one takes a strip of paper (a thin and long strip works best) and performs the following

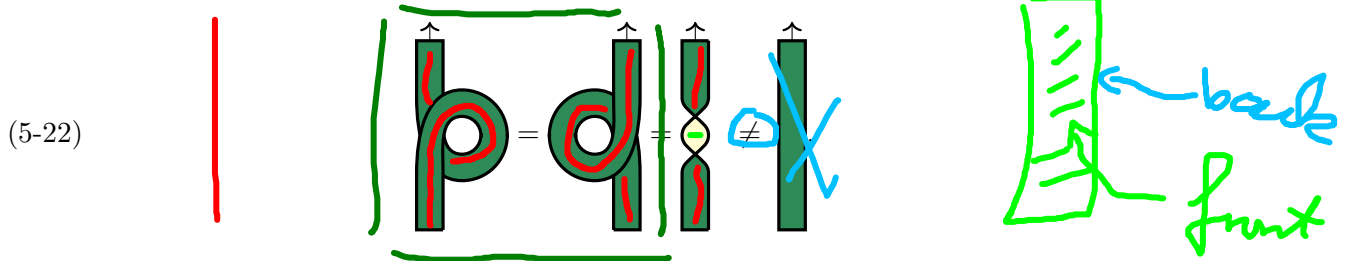

then we get the ribbon equation (5-18). However, the paper strip is twisted, so (5-17) does not hold. This motivates the definition of an important category in low-dimensional topology, called the **category of ribbons** (a.k.a. paper strips) 1Ribbon, which is, of course, a ribbon category. This category consists of oriented ribbons embedded in three space, e.g.



By making them arbitrary thin, these ribbons can be identified with the usual diagrams in the Reidemeister calculus with (5-22) being the difference between ribbons, which have two sides, say green and white colored, and strings, which do not have any sides.

Example 5.45 The (generic) oriented ribbon quantum Brauer category orqBr is the braided pivotal category generated by one object \bullet with relations

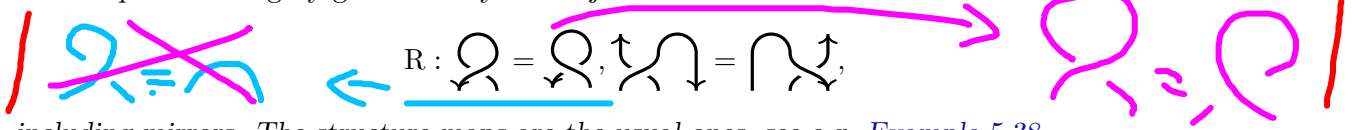

including mirrors. The structure maps are the usual ones, see e.g. Example 5.38.

The following is the point, but again non-trivial to prove.

Theorem 5.46 There exist a braided rigid functor

$$\text{orqR}: \text{orqBr} \xrightarrow{\sim} \mathbf{1Ribbon}, \bullet \mapsto \bullet,$$

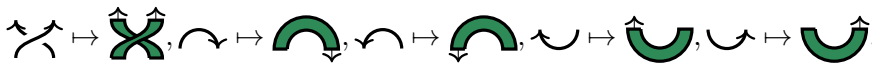

The functor is dense and fully faithful, thus, orqBr $\simeq_{\beta, \star}$ 1Ribbon.

Proof. A version of this theorem, which can be used to prove the formulation of it as above, is proven in [CP95, Section 5.3]. □

5I. Algebras in braided categories. Let us conclude this part with an continuation of Section 3E. A classical problem which we will address is to determine what condition on an algebra $A \in \mathbf{Vec}_k$ ensures that Mod_C(A) is monoidal. Two known answers are:

- The category $\mathbf{Mod}_C(A)$ is monoidal if A is commutative.
- The category $\mathbf{Mod}_C(A)$ is monoidal if A is a bialgebra.

We will now discuss the categorical versions of these facts.

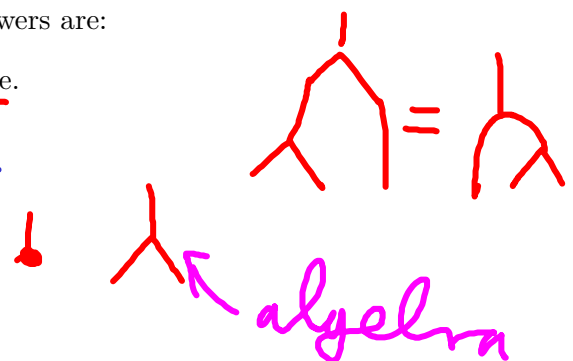

Definition 5.47 A commutative algebra $A = (A, m, i)$ in a braided category $\mathcal{C} \in \mathbf{BCat}$ is an algebra in \mathcal{C} such that

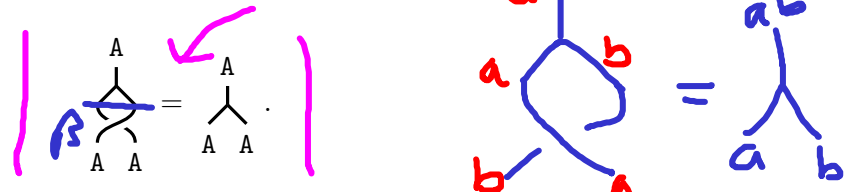
(5-23) 

A cocommutative coalgebra $C = (C, d, e)$ in a braided category \mathcal{C} is, by definition, a commutative algebra in \mathcal{C}^{op} .

By up-down symmetry, we can focus on algebras, since all constructions and statements for coalgebras are similar.

Example 5.48 Definition 5.47 generalizes the notions of (co)commutative (co)algebras, which can be recovered by taking $\mathcal{C} = \mathbf{Vec}_k$. More generally, as we will see later, commutative algebras in $(\mathbf{Vec}_k(\mathbb{Z}/2\mathbb{Z}), \beta_{1,1}^{su})$, see Example 5.10, are supercommutative algebras.

A classical result is that for commutative algebras the notions of left, right and bimodules agree. Categorically this is also the case:

Proposition 5.49 Let $A \in \mathcal{C}$ be a commutative algebra.

- (i) Every $M \in \mathbf{Mod}_{\mathcal{C}}(A)$ has the structure of a left A module.
- (ii) Every $N \in (A)\mathbf{Mod}_{\mathcal{C}}$ has the structure of a right A module.
- (iii) We have equivalences of categories

$$\underline{\mathbf{Mod}_{\mathcal{C}}(A) \simeq (A)\mathbf{Mod}_{\mathcal{C}} \simeq (A)\mathbf{Mod}_{\mathcal{C}}(A)}.$$



Consequently, $\mathbf{Mod}_{\mathcal{C}}(A)$ is a monoidal category with $\otimes = \otimes_A$ and $\mathbb{1} = A$.

Proof. (i). We can define a left action on M via

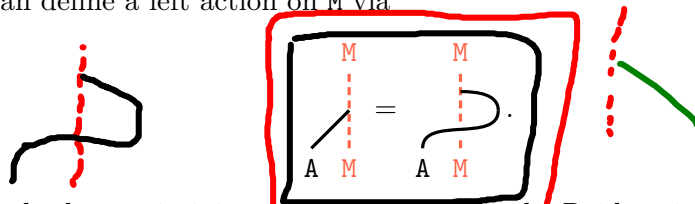

We now need to check associativity and unitality using the Reidemeister calculus as well as the diagrammatics for right actions:

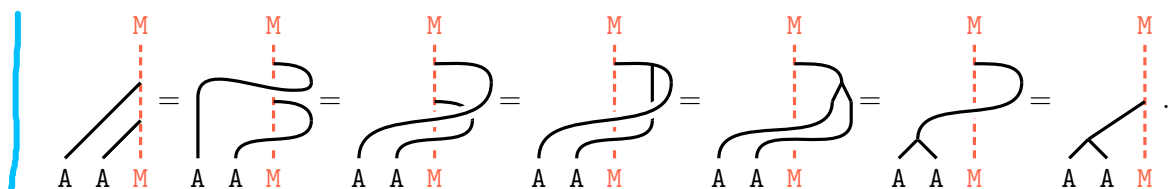

Note that the fourth equality uses commutativity (5-23). Similarly, we compute



This shows (i).

(ii). By symmetry.

(iii). The following verifies that right and left action commute:

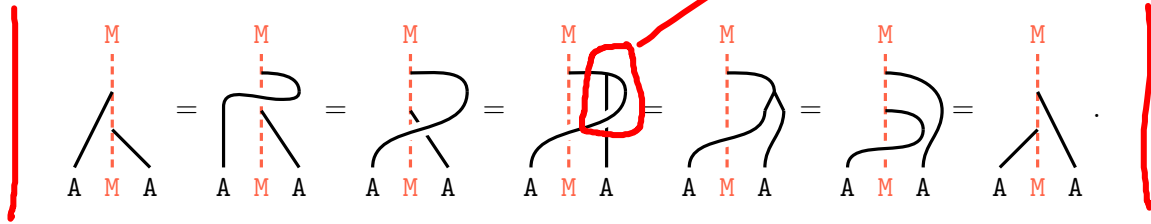

Thus, we can define a bimodule structure on $M \in \mathbf{Mod}_{\mathbf{C}}(A)$ and also, by symmetry, on $N \in (A)\mathbf{Mod}_{\mathbf{C}}$. Moreover, we can also match the equivariant morphisms, e.g.

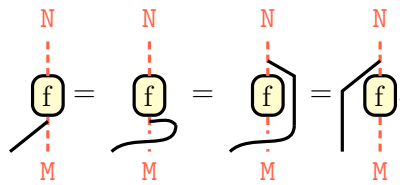

One then easily verifies that one gets the claimed equivalences of categories. □

We can also define the monoidal structure on $\mathbf{Mod}_{\mathbf{C}}(A)$ diagrammatically:

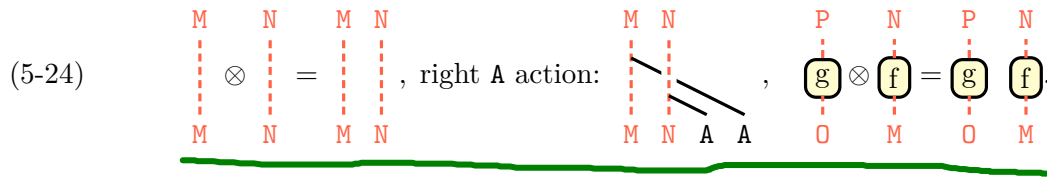

Thus, a good question would be whether $\mathbf{Mod}_{\mathbf{C}}(A)$ is also braided. This is not quite the case:

Definition 5.50 For any commutative algebra $A \in \mathbf{C}$ let $\mathbf{Mod}_{\mathbf{C}}^{\beta}(A) \subset \mathbf{Mod}_{\mathbf{C}}(A)$ denote the full subcategory with objects satisfying



The right A modules satisfying (5-25) are also sometimes called **braided** for the following reason.

Proposition 5.51 For any commutative algebra $A \in \mathbf{C}$ the category $\mathbf{Mod}_{\mathbf{C}}^{\beta}(A)$ is braided with braiding inherited from \mathbf{C} .

Proof. This is Exercise 5.64. □

Example 5.52 If $\mathbf{C} \in \mathbf{BCat}$ is symmetric, then, using Reidemeister calculus, we see that (5-25) becomes

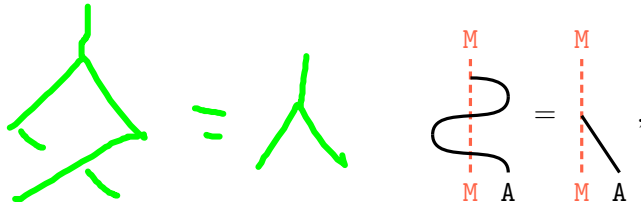

which holds for all objects, i.e. $\mathbf{Mod}_{\mathbf{C}}^{\beta}(A) = \mathbf{Mod}_{\mathbf{C}}(A)$. Furthermore, we have $\mathbf{Mod}_{\mathbf{C}}(A) \in \mathbf{BCat}$ is also symmetric. In particular, classically, the module categories of any commutative algebra in \mathbf{Vec}_k are symmetric.

Another answer is that $\mathbf{Mod}_{\mathbf{C}}(A)$ is monoidal if A is a bialgebra. We will see that the same is true categorically. Since this is important let us be precise:

Definition 5.53 A bialgebra $A = (A, m, i, d, e)$ in a category $\mathbf{C} \in \mathbf{BCat}$ consist of

- an algebra $A = (A, m, i) \in \mathbf{C}$;
- a coalgebra $A = (A, d, e) \in \mathbf{C}$;

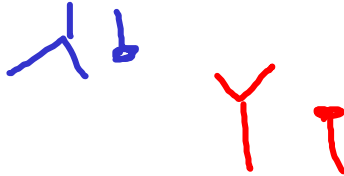

such that

(i) we have the unitality conditions

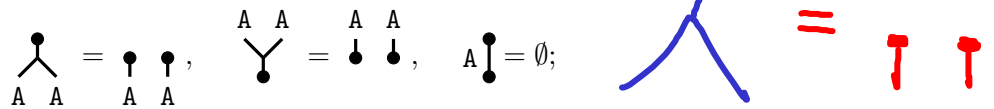

(ii) we have the compatibility condition

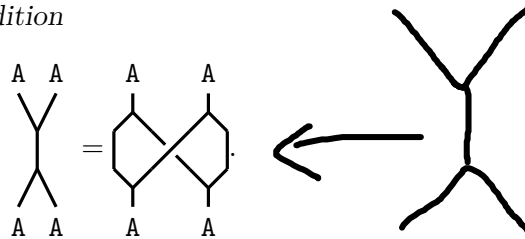

Proposition 5.54 For any bialgebra $A \in \mathbf{C}$ the assignment as in (5-24) but

(5-26)

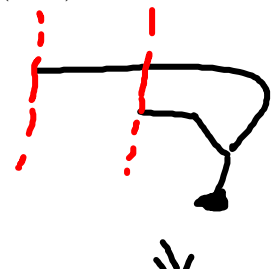
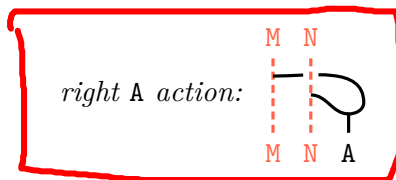

defines a monoidal structure on $\mathbf{Mod}_{\mathbf{C}}(A)$.

Proof. First note that (5-26) is a well-defined right A action. For example,

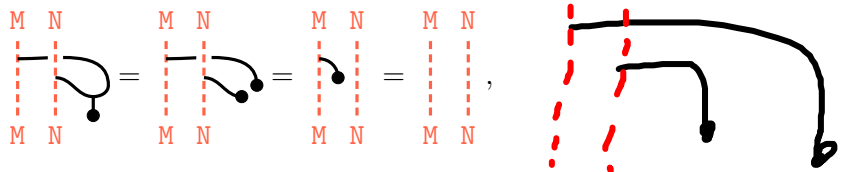

verifies unitality, where the first equality is using [Definition 5.53.\(i\)](#). Moreover,

$\text{Mod}(A) \otimes ?$

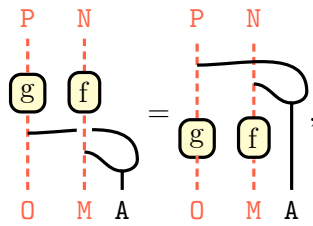

shows that A equivariant morphisms go to A equivariant morphisms under \otimes , showing that the assignment is well-defined, i.e. \otimes stays within $\text{Mod}_{\mathbf{C}}(A)$. Verifying that this assembles into a monoidal structure works then exactly in the same way as for any horizontal juxtaposition. \square

5J. **Hopf algebras in braided rigid categories.** To get our examples later on, we do some diagrammatics again.

Definition 5.55 A pre Hopf algebra $A = (A, m, i, d, e, s)$ in a category $\mathbf{C} \in \mathbf{BCat}$ consist of

- a bialgebra $A = (A, m, i, d, e) \in \mathbf{C}$;
- an antipode $(s: A \rightarrow A) \in \mathbf{C}$, illustrated by

$\text{Mod}(A)$
* ?



such that

(i) we have the antipode condition

(5-27)

If s is invertible, then we call A a Hopf algebra.

Hopf algebras kind of generalize commutative algebras, e.g. compare (5-23) to:

Lemma 5.56 For any pre Hopf algebra $A \in \mathbf{C}$ for $\mathbf{C} \in \mathbf{BCat}$ we have **sliding**, i.e.

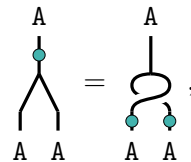

including its horizontal mirror.

Proof. Via the Reidemeister calculus and (5-27), see e.g. [Ma94, Lemma 2.3]. \square

Further, the following should be compared to [Proposition 5.49](#):

Proposition 5.57 Let $A \in \mathbf{C}$ for $\mathbf{C} \in \mathbf{BCat}$ be a pre Hopf algebra.

(i) Every $M \in \mathbf{Mod}_{\mathbf{C}}(\mathbf{A})$ has the structure of a left \mathbf{A} module.

(ii) Every $N \in (\mathbf{A})\mathbf{Mod}_{\mathbf{C}}$ has the structure of a right \mathbf{A} module.

Proof. Of course, (i) and (ii) are equivalent up to right-left symmetry, and it suffices to prove (i).

(i). We can define a left action on M via

(5-28) 

Using sliding Lemma 5.56, we see that (5-28) satisfies associativity:

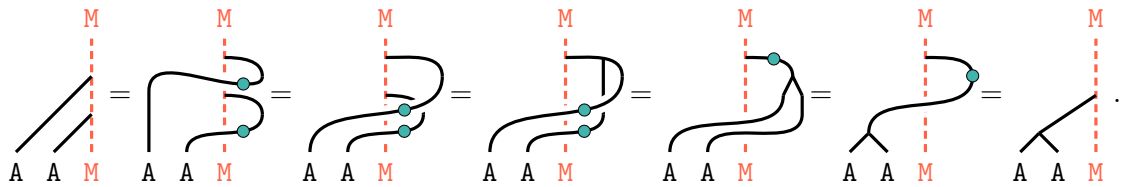

(Note that this is almost the same argument as in Proposition 5.49.) The easier proof that (5-28) also satisfies unitality is omitted. \square

Let us say **right rigid** and **left rigid** in case only the right respectively left duals need to exist.

Theorem 5.58 For any pre Hopf algebra $\mathbf{A} \in \mathbf{C}$ where $\mathbf{C} \in \mathbf{BRCat}$ we have:

(i) The category $\mathbf{Mod}_{\mathbf{C}}(\mathbf{A})$ is right rigid with duality inherited from \mathbf{C} .

(ii) The category $(\mathbf{A})\mathbf{Mod}_{\mathbf{C}}$ is left rigid with duality inherited from \mathbf{C} .

(iii) If \mathbf{A} is a Hopf algebra, then both, $\mathbf{Mod}_{\mathbf{C}}(\mathbf{A})$ and $(\mathbf{A})\mathbf{Mod}_{\mathbf{C}}$, are rigid with duality inherited from \mathbf{C} .

Proof. (i). First, Proposition 5.54 shows that we get a monoidal structure, and by Proposition 4.65 we then get that right duals, using this monoidal structure, have an action of \mathbf{A} , but from the wrong side. However, by Proposition 5.57 we can swap sides of the actions.

(ii) By (i) via symmetry.

(iii). To define a left action on the left dual ${}^*\mathbf{M}$ we first denote the inverse of the antipode by

$$s^{-1} \rightsquigarrow \begin{array}{c} \mathbf{A} \\ \uparrow \\ \circlearrowleft \\ \mathbf{A} \end{array}.$$

In order to define a right action on ${}^*\mathbf{M}$ recall from (5-28) that M has a left action. Thus, we can define a right action on ${}^*\mathbf{M}$ via

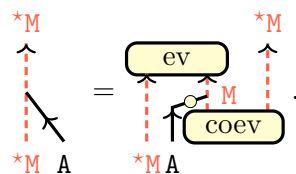

The invertibility comes into play since one needs e.g.

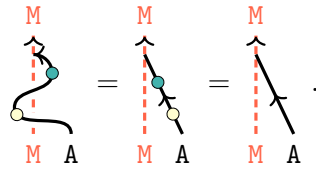

The second claim in (iii) follows again by symmetry. □

Example 5.59 Again, this generalizes several notions:

- (a) Hopf algebras in \mathbf{Vec}_k are classical Hopf algebras. A particular example is $k[G]$. Thus, we recover the classical result that $\mathbf{fdMod}(k[G])$ is rigid.
- (b) Hopf algebras in $\mathbf{Vec}_{\mathbb{C}}(\mathbb{Z}/2\mathbb{Z})$ with its super braiding could be called super Hopf algebras.

5K. **Summary of the interplay between topology and categorical algebra.** Some (the most important) Brauer categories we have seen are summarized in the following table.

	monoidal	braided	pivotal	symmetric	self-dual •	Reidemeister 1	topology
Br	Y	Y	Y	Y	Y	Y	1Cob
qBr	Y	Y	Y	N	Y	Y	1Tan
oqBr	Y	Y	Y	N	N	Y	1State
orqBr	Y	Y	Y	N	N	N	1Ribbon

We leave it to the reader to fill in all the various versions using the adjectives “oriented”, “quantum” and “ribbon”. Let us use the placeholder $_$, which can be filled in with these adjective.

The point is that they are all equivalent to their topological incarnations while “free XYZ with properties ABC”. Thus, we “define”:

A quantum invariant Q is a structure preserving functor

$$Q: _ \mathbf{Br} \rightarrow \mathbf{C},$$

where \mathbf{C} is “a linear algebra like category”.

← linear algebra

The aim of the following lectures is to make precise what “a linear algebra like category”, a.k.a. “a category where we can compute”, might mean, the guiding example being \mathbf{fdVec}_k .

5L. **Exercises.**

Exercise 5.60 Prove that $(\mathbf{Vec}_{\mathbb{C}}(\mathbb{Z}/2\mathbb{Z}), \beta_{1,1}^{st}) \not\cong_{\beta} (\mathbf{Vec}_{\mathbb{C}}(\mathbb{Z}/2\mathbb{Z}), \beta_{1,1}^{su})$, where the standard and super braidings are defined in Example 5.10.

Exercise 5.61 Verify the claims in Example 5.15 and Remark 5.16.

Exercise 5.62 For any $\mathbf{C} \in \mathbf{BCat}$ show that $\mathbf{C}^{op}, \mathbf{C}^{co}, \mathbf{C}^{coop} \in \mathbf{BCat}$ by defining braidings on them using the braiding of \mathbf{C} .

Exercise 5.63 With respect to [Remark 5.30](#), write down all only implicitly stated relations for \mathbf{qBr} and \mathbf{oqBr} . What about e.g.

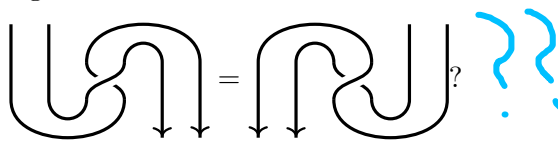

Exercise 5.64 Prove [Proposition 5.51](#) and verify the missing claims in [Proposition 5.54](#).

6. ADDITIVE, LINEAR AND ABELIAN CATEGORIES – DEFINITIONS AND EXAMPLES

A topological invariant should be computable, i.e. within the realm of linear or homological algebra. So:

What is the analog of linear or homological algebra in a categorical language?

6A. Conventions. We keep all conventions from before, including all abbreviations which we used. Let us stress one:

Convention 6.1 Similarly as in [Convention 2.3](#), we will write e.g. \oplus instead of $\oplus_{\mathbb{C}}$.

Convention 6.2 We will see a lot of objects defined via some universal property. By a very general type of argument, which we will call a **universality argument**, see [Section 6D](#), such objects are unique up to unique isomorphism. Since these arguments are very similar, we usually omit the corresponding proofs. Moreover, these objects usually are objects together with extra data such as a morphism, but we tend to treat them as objects if no confusion can arise.

Convention 6.3 Recall from [Section 3E](#) that a \mathbb{k} algebra is an algebra in $\mathbf{Vec}_{\mathbb{k}}$. Similarly, a **ring** for us is an algebra object in $\mathbf{Vec}_{\mathbb{Z}}$ (the category of abelian groups, see [Example 1.8](#)), in particular, associative and unital. Moreover, throughout, \mathbb{S} denotes commutative ring, i.e. a commutative algebra in $\mathbf{Vec}_{\mathbb{Z}}$.

field
ring $\mathbb{S} = \mathbb{Z}, \mathbb{K}, \mathbb{R}$

6B. A motivating example. As we have already seen, the “multiplication” $\otimes_{\mathbb{k}}$ of $\mathbf{Vec}_{\mathbb{k}}$ generalizes to the notion of monoidal categories. Let us now focus on the “addition” \oplus of $\mathbf{Vec}_{\mathbb{k}}$.



- First, we note that $\mathbf{Hom}_{\mathbf{Vec}_{\mathbb{k}}}(X, Y) \in \mathbf{Vec}_{\mathbb{k}}$. Or in words, hom spaces between \mathbb{k} vector spaces are, of course, \mathbb{k} vector spaces again. In particular, they are abelian groups, meaning that we can add and subtract morphisms $f, g \in \mathbf{Hom}_{\mathbf{Vec}_{\mathbb{k}}}(X, Y)$ and the results $f \pm g$ are still in $\mathbf{Hom}_{\mathbf{Vec}_{\mathbb{k}}}(X, Y)$. There is also an additive unit, the zero map 0, additive inverses and composition is biadditive.

\mathbb{Z} -mod

Remark 6.4 We can, of course, also use scalars from \mathbb{k} , and this property will below be called \mathbb{k} linear. However, for now the condition of being an abelian group or, equivalently, \mathbb{Z} linear is relevant for us.

- Second, we have a zero object, the zero \mathbb{k} vector spaces 0 , which satisfies:

(6-1) For all $X \in \mathbf{Vec}_{\mathbb{k}}$ there exist unique morphisms $0: X \rightarrow 0, 0: 0 \rightarrow X$.

The morphisms in (6-1) are called the zero morphisms and they are the zero maps.

- Finally, we consider the pair category (see Definition 1.12) $\mathbf{Vec}_k \times \mathbf{Vec}_k$ and we have a bifunctor

$$K \oplus K \simeq K^2$$

$$\oplus: \mathbf{Vec}_k \times \mathbf{Vec}_k \rightarrow \mathbf{Vec}_k, \quad \oplus((X, Y)) = X \oplus Y, \quad \oplus((f, g)) = f \oplus g,$$

called the direct sum, using again abbreviations of the form $X \oplus Y$ instead of $\oplus((X, Y))$.

We note that the object $X \oplus Y$ has a universal-type property, namely: there exist morphisms $i_X, i_Y, p_X, p_Y \in \mathbf{Vec}_k$ such that

$$(6-2) \quad \begin{array}{c} X \oplus Y \\ \swarrow i_X \quad \searrow i_Y \\ X \quad \quad Y \\ \swarrow p_X \quad \searrow p_Y \end{array}, \quad p_X i_X = \text{id}_X, \quad p_Y i_Y = \text{id}_Y, \quad i_X p_X + i_Y p_Y = \text{id}_{X \oplus Y}.$$

The two morphisms i_X and i_Y are called inclusions, the other two p_X and p_Y projections (of X and Y , respectively).

6C. An even more down to earth motivating example. Let us be completely explicit and consider the situation of \mathbf{Mat}_k . In this case the three observations above take the following form.

- Matrices can be added and this is bilinear with respect to multiplication \circ , e.g.

$$\left(s \cdot \begin{pmatrix} a & b \\ c & d \end{pmatrix} \right) \circ \left(t \cdot \begin{pmatrix} e & f \\ g & h \end{pmatrix} \right) = st \cdot \left(\begin{pmatrix} a & b \\ c & d \end{pmatrix} \circ \begin{pmatrix} e & f \\ g & h \end{pmatrix} \right).$$

- There exists a zero 0 and a zero matrix $0 = (0)$.

- We can add numbers and there exist block matrices and corresponding inclusions and projections of blocks, e.g.

$$2 \oplus 2 = 4, \quad i_2^{\leftarrow} = \begin{pmatrix} 1 & 0 \\ 0 & 1 \\ 0 & 0 \\ 0 & 0 \end{pmatrix}, \quad i_2^{\rightarrow} = \begin{pmatrix} 0 & 0 \\ 0 & 0 \\ 1 & 0 \\ 0 & 1 \end{pmatrix}, \quad p_2^{\leftarrow} = \begin{pmatrix} 1 & 0 & | & 0 & 0 \\ 0 & 1 & | & 0 & 0 \end{pmatrix}, \quad p_2^{\rightarrow} = \begin{pmatrix} 0 & 0 & | & 1 & 0 \\ 0 & 0 & | & 0 & 1 \end{pmatrix}.$$

6D. A brief reminder on universality. Let $F \in \mathbf{Hom}(\mathbf{C}, \mathbf{D})$ be a functor between categories $\mathbf{C}, \mathbf{D} \in \mathbf{Cat}$. Then a pair $(X, f: Y \rightarrow F(X))$ in \mathbf{D} satisfies a universal property for Y and F if for any $g: Y \rightarrow F(Z)$ there exist a unique $u: X \rightarrow Z$ making

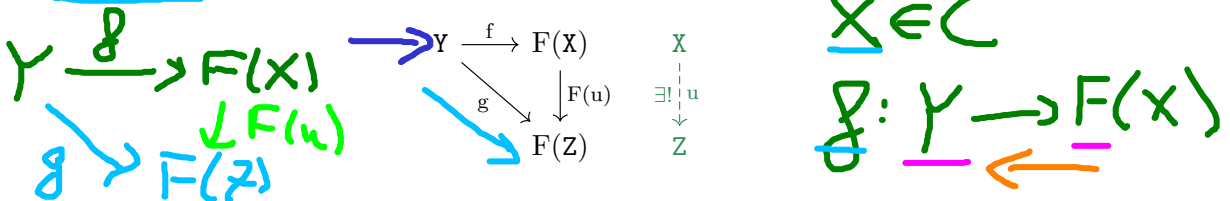

commutative. A universal property for F and Y is defined similarly, with \mathbf{C}^{op} and \mathbf{D}^{op} instead of \mathbf{C} and \mathbf{D} .

Example 6.5 Let $\mathbf{D} = \mathbf{Set}$. Then the product $X_1 \times X_2$ comes with the two coordinate projections p_1 and p_2 and satisfies a universal property. This universal property will take place in $\mathbf{Set} \times \mathbf{Set}$ (the pair category from Definition 1.12) can be formulated as follows. First, let $F: \mathbf{Set} \rightarrow \mathbf{Set} \times \mathbf{Set}$ be the diagonal functor. Then the pair $(X_1 \times X_2, (p_1, p_2))$ satisfies a universal property from F to

$$X \rightarrow X \times X$$

(X_1, X_2) , i.e. we have

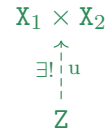
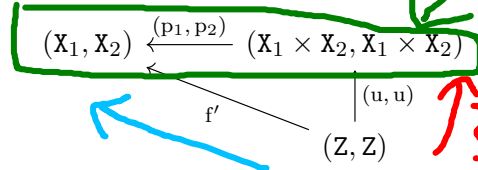

$X_1 \times X_2 \leftarrow F(X_1, X_2)$

critical $F(?)$

Lemma 6.6 A pair (X, f) satisfying a universal property for Y and F , if it exists, is unique up to unique isomorphism, i.e. if (X', f') is another pair, then there exists a unique isomorphism $h: X \xrightarrow{\cong} X'$ such that $f' = F(h)f$. Similarly for pairs F and Y .

Proof. It follows by substituting (X', f') into the definition for (X, f) that h exists uniquely, i.e.

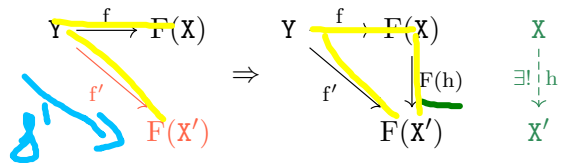

By symmetry, we also get a unique $h': X' \rightarrow X$, which we paste together with h :

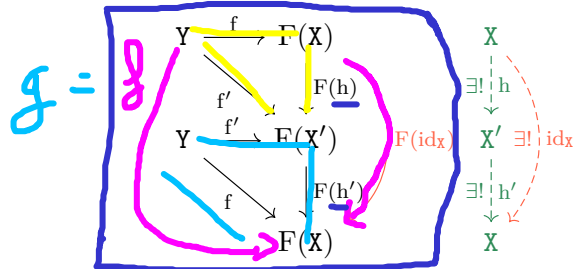

However, there already exists a morphisms $X \rightarrow X$ making the outer part above commutative, namely id_X . Thus, $h'h = id_X$ and, by symmetry, $hh' = id_{X'}$. \square

good δ bad δ

Notions defined by universal properties are unique if they exist, but they do not have to exist in general. Nevertheless, recall from Convention 3.4 that we do not write “assuming that XYZ exists” below, and these will be implicit assumption for e.g. statements such as the ones in Lemma 6.31 to make sense.

6E. **Linear algebra in categories.** We generalize the situations of **Vec_k** and **Mat_k**.

Definition 6.7 A category $C \in \mathbf{Cat}$ is called \mathbb{S} linear if the space $\text{Hom}_C(X, Y)$ is an \mathbb{S} module for all $X, Y \in \mathbf{Cat}$ and composition is \mathbb{S} bilinear.

Definition 6.8 A category $C \in \mathbf{Cat}$ is called additive if

- it is \mathbb{Z} linear;
- there exists a zero object $0 \in \mathbf{Cat}$ (meaning an object satisfying (6-1));
- for all $X, Y \in \mathbf{Cat}$ there exists an object $X \oplus Y$ called **direct sum**, which satisfies the universal property in (6-2).

Example 6.9 The properties of being \mathbb{S} linear and additive are parallel to each other: one asks for linearity of hom spaces, the other for existence of direct sums.

- (a) The category Set is neither \mathbb{S} linear nor additive.
- (b) The categories \mathbf{Vec}_k and \mathbf{fdVec}_k are k linear additive.
- (c) The categories of the form $\mathbf{Vec}_k^\omega(G)$ are k linear, but not additive.
- (d) The category $\mathbf{Vec}_\mathbb{Z}$ is additive, but not k linear (but, of course, \mathbb{Z} linear).

Example 6.10 Additive categories need to be closed under \oplus . For example, the full subcategory $\mathbf{evenVec}_k \subset \mathbf{fdVec}_k$ of even dimensional k vector spaces is k linear additive, while the full subcategory $\mathbf{oddVec}_k \subset \mathbf{fdVec}_k$ of odd dimensional k vector spaces is only k linear.

The following is (almost) immediate.

Lemma 6.11 Let $\mathbf{C} \in \mathbf{Cat}$ be additive. Then there exists a bifunctor $\oplus: \mathbf{Cat} \times \mathbf{Cat} \rightarrow \mathbf{Cat}$ called direct sum. \square

We again can say “the” direct sum, justified by the following lemma whose proof is a universality argument:

Lemma 6.12 Up to unique isomorphisms, $\mathbf{X} \oplus \mathbf{Y}$ is the only object in \mathbf{C} satisfying (6-2). \square

Definition 6.13 An \mathbb{S} linear functor $F \in \mathbf{Hom}(\mathbf{C}, \mathbf{D})$ between \mathbb{S} linear categories is a functor such that the induced map

$$\mathbf{Hom}_{\mathbf{C}}(\mathbf{X}, \mathbf{Y}) \rightarrow \mathbf{Hom}_{\mathbf{D}}(F(\mathbf{X}), F(\mathbf{Y}))$$

is \mathbb{S} linear for all $\mathbf{X}, \mathbf{Y} \in \mathbf{C}$.

On the first glance **Definition 6.13** looks like the “wrong definition” for additive categories since it does not involve the direct sums. However, the slogan is “linear implies additive”:

Lemma 6.14 Let $F \in \mathbf{Hom}(\mathbf{C}, \mathbf{D})$ be \mathbb{Z} linear, and let \mathbf{C} and \mathbf{D} be additive. Then there exists a natural isomorphism $F(\mathbf{X} \oplus \mathbf{Y}) \cong F(\mathbf{X}) \oplus F(\mathbf{Y})$.

Proof. Note that being \mathbb{Z} linear gives us the equality

$$F(f + g) = F(f) + F(g).$$

Thus, all of the equations in (6-2) are preserved by F which implies that $F(\mathbf{X} \oplus \mathbf{Y})$ is a direct sum of $F(\mathbf{X})$ and $F(\mathbf{Y})$, and the claim follows from **Lemma 6.12**. \square

The following is as usual not hard to see:

Lemma 6.15 The identity functor on an \mathbb{S} linear category is \mathbb{S} linear. Moreover, if F and G are \mathbb{S} linear functors, then so is GF . \square

Example 6.16 By **Lemma 6.14**, we get the categories of \mathbb{S} linear categories $\mathbf{Cat}_{\mathbb{S}}$ and the category of additive categories \mathbf{Cat}_{\oplus} at the same time, morphism being the appropriate linear functors. Also important is the category $\mathbf{Cat}_{\mathbb{S}\oplus}$ of \mathbb{S} linear additive categories, the

morphisms being \mathbb{S} linear functors, as well as the corresponding functor categories $\mathbf{Hom}_{\mathbb{S}}(\mathbf{C}, \mathbf{D})$, $\mathbf{Hom}_{\oplus}(\mathbf{C}, \mathbf{D})$ and $\mathbf{Hom}_{\mathbb{S}\oplus}(\mathbf{C}, \mathbf{D})$.

Definition 6.17 $\mathbf{C}, \mathbf{D} \in \mathbf{Cat}_{\mathbb{S}\oplus}$ are called equivalent as \mathbb{S} linear additive categories, denoted by $\mathbf{C} \simeq_{\mathbb{S}\oplus} \mathbf{D}$, if there exists an equivalence $F \in \mathbf{Hom}_{\mathbb{S}\oplus}(\mathbf{C}, \mathbf{D})$. Similarly in the \mathbb{S} linear and additive setup, using the appropriate linear functors.

6F. The linear extension and the additive closure. The following constructions allow us to perform linear algebra in almost all categories.

Definition 6.18 The \mathbb{S} linear extension of $\mathbf{C} \in \mathbf{Cat}$, denoted by $\mathbf{C}_{\mathbb{S}}$, is the category with $\text{Ob}(\mathbf{C}_{\mathbb{S}}) = \text{Ob}(\mathbf{C})$ and

$$\text{Hom}_{\mathbf{C}_{\mathbb{S}}}(\mathbf{x}, \mathbf{y}) = \mathbb{S}\{\text{Hom}_{\mathbf{C}}(\mathbf{x}, \mathbf{y})\},$$

and the composition being the evident \mathbb{S} linear extension of the composition in \mathbf{C} .

In words, the hom spaces of $\mathbf{C}_{\mathbb{S}}$ are the free \mathbb{S} modules with basis set being the corresponding hom space in \mathbf{C} .

Example 6.19 To match our previous conventions, let $\mathbb{S} = \mathbb{k}$.

(a) We have $\mathbf{Set}_{\mathbb{k}} \simeq_{\mathbb{k}} \mathbf{Vec}_{\mathbb{k}}$.

(b) We have $\mathbf{Vec}(G)_{\mathbb{k}} \simeq_{\mathbb{k}} \mathbf{Vec}_{\mathbb{k}}(G)$.



Example 6.20 For diagrammatic categories such as the Brauer category \mathbf{Br} , taking the \mathbb{S} linear extension amounts to taking formal sums of pictures with the same endpoints, e.g.

$$\frac{55}{12} \cdot \text{crossing} - \frac{2}{3} \cdot \text{cup} \in \mathbf{Br}_{\mathbb{Q}}, \quad \text{crossing} + \text{cup} \notin \mathbf{Br}_{\mathbb{Q}}.$$

Since each diagram is a basis element, by definition, simplification of scalars is only allowed if the diagrams are the same. Moreover, composition is bilinear, meaning e.g.

$$12 \cdot \text{cup} \circ (\frac{55}{12} \cdot \text{crossing} - \frac{2}{3} \cdot \text{cup}) = 55 \cdot \text{cup} - 8 \cdot \text{cup} = 55 \cdot \text{cup} - 8 \cdot \text{cup},$$

where we have used one of the Brauer relations (3-2) in the last step.

Recall our notation for free monoids from Section 3B.

Definition 6.21 The additive closure of $\mathbf{C} \in \mathbf{Cat}_{\mathbb{S}}$, denoted by \mathbf{C}_{\oplus} , is the category with $\text{Ob}(\mathbf{C}_{\oplus}) = \langle \text{Ob}(\mathbf{C}) \mid \emptyset \rangle$ (the composition is written \oplus) and

$$\text{Hom}_{\mathbf{C}_{\oplus}}(\mathbf{X}_1 \oplus \dots \oplus \mathbf{X}_c, \mathbf{Y}_1 \oplus \dots \oplus \mathbf{Y}_r) = \{(f_{ij})_{i=1, \dots, c}^{j=1, \dots, r} \mid f_{ij} \in \text{Hom}_{\mathbf{C}}(\mathbf{X}_j, \mathbf{Y}_i)\},$$

and the composition being matrix multiplication.

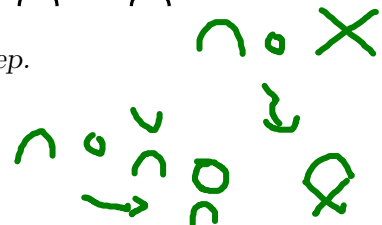

In words, the objects of \mathbf{C}_\oplus are formal (finite) direct sums of objects of \mathbf{C} and the hom spaces of \mathbf{C}_\oplus are matrices whose entries are morphisms of \mathbf{C} :

$$(f_{ij})_{i=1, \dots, r}^{j=1, \dots, c} \longleftrightarrow \begin{pmatrix} f_{11} & \dots & f_{1c} \\ \vdots & \ddots & \vdots \\ f_{r1} & \dots & f_{rc} \end{pmatrix}.$$

(Handwritten notes: $f: x \rightarrow c$, $g: y \rightarrow c$, (f_{ij}) , $x \oplus y \rightarrow z$)

In particular, the following is clear, saying that the additive closure is a closure:

Lemma 6.22 For all $\mathbf{C} \in \mathbf{Cat}_S$ we have $\mathbf{C}_\oplus \simeq_\oplus (\mathbf{C}_\oplus)_\oplus$. □

Example 6.23 With respect to $\mathbf{Vec}(G)$ we have interesting examples:

(a) In $\mathbf{Vec}_{\mathbb{k}\oplus}(G)$, which is defined as first taking the \mathbb{k} linear extension and then the additive closure of $\mathbf{Vec}(G)$, objects are formal direct sums of group elements, while morphisms are honest matrices with a restriction on entries coming from $\text{Hom}_{\mathbf{Vec}_{\mathbb{k}}(G)}(i, j) = 0$ if $i \neq j$.

(b) The category $\mathbf{Vec}_{\mathbb{k}\oplus}(G)$ is called the category of G -graded \mathbb{k} vector spaces. Important special cases are:

- For $G = 1$ we have $\mathbf{Vec}_{\mathbb{k}\oplus}(1) \simeq \mathbf{fdVec}_{\mathbb{k}}$. In particular, Theorem 5.26 implies that, after choosing the monoidal structure, $\mathbf{fdVec}_{\mathbb{k}}$ has only one structure of a braided category.
- For $G = \mathbb{Z}/2\mathbb{Z}$ another common name is the category of (finite dimensional) super vector spaces. This category has two braidings by Theorem 5.26, the non-symmetric one is called the super braiding.

As in Example 6.23 the notation $\mathbb{S}\oplus$ means taking first the \mathbb{S} linear extension, and then the additive closure.

Example 6.24 For diagrammatic categories we get a diagram calculus of matrices. For example

$$\left(\begin{array}{c} \text{---} \\ \text{---} \end{array} \right) \circ \left(\begin{array}{c} \text{---} \\ \text{---} \end{array} \right) = \text{---} + \text{---}, \quad \left(\begin{array}{c} \text{---} \\ \text{---} \end{array} \right) \circ \left(\begin{array}{c} \text{---} \\ \text{---} \end{array} \right) = \begin{pmatrix} \text{---} & \text{---} \\ \text{---} & \text{---} \end{pmatrix},$$

are computations in $\mathbf{oBr}_{\mathbb{S}\oplus}$.

Proposition 6.25 We have the following.

- (i) For any $\mathbf{C} \in \mathbf{Cat}$ we have $\mathbf{C}_S \in \mathbf{Cat}_S$.
- (ii) There is a dense and faithful functor $L: \mathbf{C} \hookrightarrow \mathbf{C}_S$ given by S linearization.
- (iii) If $\mathbf{C} \in \mathbf{Cat}$ is monoidal (or rigid or pivotal or braided etc.), then so is \mathbf{C}_S with its structure induced from \mathbf{C} .

Similarly for \mathbf{C}_\oplus , except that the corresponding functor in (ii) is fully faithful, but not dense.

Proof. This is Exercise 6.93. □

Here is the analog of Proposition 6.26.

Proposition 6.26 Let $F \in \text{Hom}(\mathbf{C}, \mathbf{D})$. Then there exists a unique $F_{\mathbb{S}} \in \text{Hom}_{\mathbb{S}}(\mathbf{C}_{\mathbb{S}}, \mathbf{D}_{\mathbb{S}})$ such that we have a commuting diagram

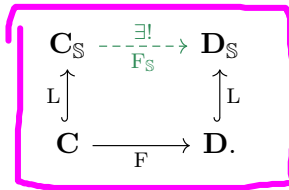

Similarly for additive closures.

Proof. The functor $F_{\mathbb{S}}$ is the \mathbb{S} linear extension of F .

free lunch theorem \square

Proposition 6.25 and **Proposition 6.26** in words say that we can do linear algebra in categories without losing our original category: one can check that “all properties we care about behave nicely with \mathbb{S} linear extensions and additive closures”, e.g. if F is monoidal, then so is $F_{\mathbb{S}}$.

6G. The first steps towards homological algebra in categories. First, the generalization of a kernel:

Definition 6.27 For a category $\mathbf{C} \in \text{Cat}_{\oplus}$ and $f \in \mathbf{C}$ we say $\text{Ker}(f) = (\text{Ker}(f), k: \text{Ker}(f) \rightarrow X)$ is a kernel of f if it has the universal property of the form

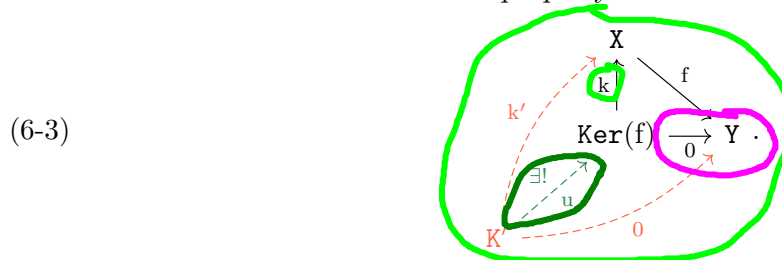

A cokernel of f , denoted by $\text{Coker}(f) = (\text{Coker}(f), c)$, is a kernel of f in \mathbf{C}^{op} .

Universality gives:

Lemma 6.28 Up to unique isomorphisms, $\text{Ker}(f)$ is the only object in \mathbf{C} satisfying (6-3). Similarly for the cokernel. \square

Example 6.29 As usual with universal objects, they might not exist:

- (a) In Vec_k and fdVec_k (co)kernels exist and are the usual (co)kernels.
- (b) The category evenVec_k does not have (co)kernels in general since the morphisms in evenVec_k might be of odd rank.
- (c) Diagrammatic categories such as Br_{k⊕} usually do not have (co)kernels.

The usual convention to identify kernels with their objects $\text{Ker}(f)$ is a bit misleading, in particular in skeletal categories:

Example 6.30 In $\text{Mat}_{\mathbb{Q}}$ (co)kernels exist and can be described as follows. Take e.g. the matrix $f = \begin{pmatrix} 1 & 2 \\ 2 & 4 \end{pmatrix}$. Then, for any $a \in \mathbb{Q}^*$, the pairs

$$\text{Ker}(f) = (1, \begin{pmatrix} 2a \\ -a \end{pmatrix}), \quad \text{Coker}(f) = (1, (2a \ -a)),$$

$$\begin{pmatrix} 1 & 2 \\ 2 & 4 \end{pmatrix} \begin{pmatrix} 2a \\ -a \end{pmatrix} = \begin{pmatrix} 0 \\ 0 \end{pmatrix}$$

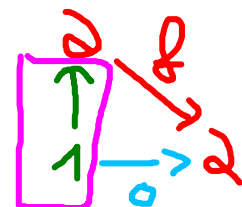

are kernels and cokernels of f , respectively. The unique isomorphism u in (6-3) for different scalars is the corresponding scaling map.

The following should remind the reader of a classical fact from linear algebra and gives us a good way to describe monic and epic morphisms, isomorphisms, subobjects, quotient objects etc. (Recall that these notions as defined in Section 1F.)

Lemma 6.31 *Let $f \in \mathbf{C}$ with $\mathbf{C} \in \mathbf{Cat}_\oplus$.*

(i) We have $\text{Ker}(\text{Ker}(f)) = 0$ and $\text{Coker}(\text{Coker}(f)) = 0$.

(ii) $\text{Ker}(f) = 0$, respectively $\text{Coker}(f) = 0$, if and only if f is monic, respectively epic.

(iii) The morphism k of $\text{Ker}(f)$ is monic, and the morphism c of $\text{Coker}(f)$ is epic.

(iv) $\text{Ker}(f) = 0 = \text{Coker}(f) = 0$ if and only if f is monic and epic if and only if f is an isomorphism.

(v) If f is monic, then $Y/X = \text{Coker}(f)$ is a quotient object of Y .

Proof. By symmetry, it suffices to prove the claims for the kernels.

(i). We write

$$\begin{array}{ccc} \text{Ker}(f) & & \\ \uparrow & \searrow k & \\ 0 & & X \\ 0 & \xrightarrow{0} & \end{array}$$

and observe that the zero object clearly satisfies the universal property of a kernel.

(ii). For $fh = fi$ we calculate $fh - fi = f(h - i) = 0$. Hence, letting $k' = h - i$, we see that $h - i = 0$ by (6.27). Conversely, if f is monic, then $fg = 0$ gives $g = 0$, which implies that the zero object is the kernel of f .

(iii). By combining (i) and (ii).

(iv). We already know by (ii) that the first two statements are equivalent, and one direction of the last statement is always true, see Lemma 1.32. So suppose that f monic and epic. Then $f = \text{Coker}(\text{Ker}(f)) = \text{Coker}(0)$, the latter always being an isomorphism.

(v). By the definition, we have a morphism $c: Y \rightarrow Y/X$, which is epic by (iii). \square

Note that we use the notation Y/X in Lemma 6.31.(v) for quotient objects since there is a natural choice for the epic morphisms in this case. The same notation will be used below, and we will also write $Y \subset X$ for subobjects, partially justified by Theorem 6.44.

Definition 6.32 *An epic-monic factorization (f, m, e) of $f \in \mathbf{C}$ with $\mathbf{C} \in \mathbf{Cat}_\oplus$ consists of*

- a kernel $(\text{ker}(f), k)$ and a cokernel $(\text{coker}(f), c)$ for f ;
- a kernel for c and a cokernel for k ;
- an object I and two morphisms $e: X \rightarrow I$ and $m: I \rightarrow Y$;

such that

(i) $f = me$;

Factor $f = \text{monic} \circ \text{epic}$

(ii) we have $(I, e) = \text{coker}(k)$ and $(I, m) = \text{ker}(c)$ giving a sequence

(6-4)

$$\text{ker}(f) \xrightarrow{k} X \xrightarrow{e} I \xrightarrow{m} Y \xrightarrow{c} \text{coker}(f) .$$

f (with arrow from X to Y)

Using Lemma 6.31 we get:

Lemma 6.33 In (6-4), the morphism e is epic and the morphism m is monic. □

Definition 6.34 For $f \in \mathbf{C}$ with $\mathbf{C} \in \mathbf{Cat}$ we say $\text{Im}(f) = (\text{Im}(f), m: \text{Im}(f) \hookrightarrow Y)$ (thus, we assume that m is monic) is an **image of f** if it has the universal property of the form



A **coimage** of f , denoted by $\text{Coim}(f) = (\text{Coim}(f), e: \text{Coim}(f) \rightarrow X)$, is an image of f in \mathbf{C}^{op} .

Example 6.35 Images in Vec_k (in its various incarnations) are the classical images of morphisms. To be completely explicit, take $f = \begin{pmatrix} 1 & 2 \\ 2 & 4 \end{pmatrix} \in \text{Mat}_{\mathbb{Q}}$. Then we can let

$$\text{Im}(f) = \left(1, \begin{pmatrix} 1 \\ 2 \end{pmatrix}\right), \quad e = (1 \ 2), \quad f = \begin{pmatrix} 1 \\ 2 \end{pmatrix} \circ (1 \ 2) = me.$$

An epic-monic factorization is also illustrated above.

$$\begin{pmatrix} 1 \\ 2 \end{pmatrix} \quad \begin{pmatrix} 1 & 2 \end{pmatrix}$$

Lemma 6.36 For $f \in \mathbf{C}$ with $\mathbf{C} \in \mathbf{Cat}_{\oplus}$ we have:

- (i) For an image $(\text{Im}(f), m)$ the morphism e is unique and epic. Similarly for coimages.
- (ii) $\text{Im}(f) \cong \text{Ker}(\text{Coker}(f))$ and $\text{Coim}(f) \cong \text{Coker}(\text{Ker}(f))$.
- (iii) If f has an epic-monic factorization, then $\text{Im}(f) \cong I$ in (6-4).

Proof. This is Exercise 6.94. □

Consequently, by universality:

Lemma 6.37 For $f \in \mathbf{C}$ with $\mathbf{C} \in \mathbf{Cat}_{\oplus}$ with an epic-monic factorization and an image, this factorization is unique up to unique isomorphism. □

Remark 6.38 Since we will later almost always work k linearly, let us stress that, clearly, all the statements above have analogs for $\mathbf{C} \in \mathbf{Cat}_{\mathbb{S}\oplus}$ instead of $\mathbf{C} \in \mathbf{Cat}_{\oplus}$. Similarly, all statements below can be (appropriately) linearized. For example, Theorem 6.44 holds verbatim with A then being a k algebra, called a **presenting algebra** of \mathbf{C} .

6H. Abelian categories. Most invariants of classical topology take place in the following type of categories.

Definition 6.39 A category $\mathbf{C} \in \mathbf{Cat}_\oplus$ is called abelian if every morphism $f \in \mathbf{C}$ has a epic-monic factorization.

Example 6.40 Abelian categories are in some sense “rare” as we will see in [Theorem 6.44](#).

(a) The names comes from the fact that $\mathbf{Vec}_\mathbb{Z}$, see [Example 1.8](#), is abelian.

(b) Of course, \mathbf{Vec}_k and \mathbf{fdVec}_k are abelian. ✓

(c) The categories $\mathbf{Vec}_{k^\oplus}(G)$ are all abelian. ✓

(d) ~~Diagrammatic categories such as \mathbf{Pr}_{k^\oplus} are usually not abelian.~~

Remark 6.41 In [Section 6F](#) we have seen linear and additive closures of categories, which allowed us to extend the power of linear algebra basically to any category. There are also several notions of an abelian envelope (one classical reference is [Fr65]). However, they always come with some form of catch: either they do not preserve structures one might care about, e.g. of being monoidal, or they do not exist in general. In words: we can not naively abelianize our favorite categories.

Definition 6.42 Let A be a ring, which we view as an algebra in $\mathbf{Vec}_\mathbb{Z}$. Then category of right A modules is defined to be $\mathbf{Mod}(A) = \mathbf{Mod}_{\mathbf{Vec}_\mathbb{Z}}(A)$, cf. [Section 3F](#).

The prototypical example of an abelian category is $\mathbf{Mod}(A)$ as well will see in [Theorem 6.44](#). !

Remark 6.43 Note that [Definition 6.39](#) implicitly assumes that kernels and cokernels exist. (This, by [Lemma 6.36](#), implies that images exist.) In fact, there are many equivalent definitions of abelian categories. However, all of these are meant to be intrinsic descriptions of the “definition” of the concrete abelian categories in [Theorem 6.44](#). cool!

The following, called the Freyd–Mitchell theorem, is the reason why all of the above looks very familiar. Note that some of the involved notions will be defined later, but we want to have the theorem stated as soon as possible: some A !

Theorem 6.44 We have the following.

(i) For every abelian category $\mathbf{C} \in \mathbf{Cat}_\oplus$ there exist a ring A such that

$$\mathbf{C} \xrightarrow{\text{exact}} \mathbf{Mod}(A),$$

i.e. \mathbf{C} is equivalent, as an abelian category, to a full subcategory of $\mathbf{Mod}(A)$. $\mathbf{C} \simeq \mathbf{Mod}(A)$

(ii) If \mathbf{C} is additionally finite, then one can find a finite dimensional A such that

$$\mathbf{C} \xrightarrow{\simeq_e} \mathbf{fdMod}(A),$$

i.e. \mathbf{C} is equivalent, as an abelian category, to $\mathbf{fdMod}(A)$. $\mathbf{C} \simeq \mathbf{fdMod}(A)$

Proof. We will sketch a proof later, for now see e.g. [Fr64, Theorem 7.34 and Exercice F]. \square

The ring A in Theorem 6.44 is called a presenting ring of C .

Remark 6.45 The psychologically useful statement in Theorem 6.44 in words says that we can think of objects of an abelian category as being A modules and of the notions we have seen above, such as e.g. kernels, as being the ones from linear algebra. However, the statement has two drawbacks: neither is A unique nor easy to compute in practice.

Example 6.46 For $\text{Vec}_{\mathbb{k}}$ one can let $A = \mathbb{k}$ in Theorem 6.44, but $A = M_{n \times n}(\mathbb{k})$, the \mathbb{k} algebra of $n \times n$ matrices with values in \mathbb{k} , works as well for any $n \in \mathbb{N}$. (This is a special case of **Morita equivalence**. Roughly, both, \mathbb{k} and $M_{n \times n}(\mathbb{k})$ have only one simple module, which is either \mathbb{k} or \mathbb{k}^n with the evident action.) In this case $\text{Vec}_{\mathbb{k}} \simeq_{\mathbb{k}\oplus} \text{Mod}(A)$ for any such A , and these are equivalences of abelian categories.

In order to define appropriate versions of functors between abelian categories (these are called exact in Theorem 6.44) we need to understand abelian categories better.

6I. **Exact sequences and functors.** Recall that in homological algebra one always has certain sequences satisfying exactness properties. Here is the analog:

Definition 6.47 A cohomologically written sequence, or sequence for short, in $C \in \text{Cat}_{\oplus}$ is a collection of objects X_i and morphisms $f_i: X_i \rightarrow X_{i+1}$ for $i \in \mathbb{Z}$. We write $(X_i, f_i)^{\bullet} \in C$ for such sequences, with zero objects being sometimes omitted. A homologically written sequence in $C \in \text{Cat}_{\oplus}$ is a cohomologically written sequence in C^{op} .

The usual way to illustrate these is

$$\dots \xrightarrow{f_{i-2}} X_{i-1} \xrightarrow{f_{i-1}} X_i \xrightarrow{f_i} X_{i+1} \xrightarrow{f_{i+1}} \dots, \quad \dots \xleftarrow{f_{i-2}} X_{i-1} \xleftarrow{f_{i-1}} X_i \xleftarrow{f_i} X_{i+1} \xleftarrow{f_{i+1}} \dots$$

By symmetry, we can focus on cohomologically written sequences from now on.

Definition 6.48 A sequence $(X_i, f_i)^{\bullet} \in C$ is called exact in i if $\text{Ker}(f_i) = \text{Im}(f_{i-1})$, and exact if its exact in i for all $i \in \mathbb{Z}$.

Example 6.49 A so-called short exact sequence (SES) is an exact sequence

$$0 \xrightarrow{i} X \xrightarrow{p} Y \xrightarrow{p} Z \xrightarrow{0} 0 \xrightarrow{0} 0 \xrightarrow{0} 0 \xrightarrow{0} \dots$$

where i is monic and p is epic by exactness and Lemma 6.31. Note also that $Z \cong Y/X$.

(a) To be completely explicit, here is a SES in $\text{Mat}_{\mathbb{Q}}$:

$$(6-5) \quad 2 \xrightarrow{i = \begin{pmatrix} 1 & 0 \\ 0 & 1 \end{pmatrix}} 3 \xrightarrow{p = (1 \ 2 \ 1)} 1, \quad 2 \xleftarrow{p' = \begin{pmatrix} 1 & 0 & 0 \\ 0 & 1 & 0 \end{pmatrix}} 3 \xleftarrow{i' = \begin{pmatrix} 0 \\ 1 \end{pmatrix}} 1$$

The right sequence is a so-called splitting of the left sequence, meaning that

$$(6-6) \quad p'i = \text{id}_2, \quad pi' = \text{id}_1, \quad ip' + i'p = \text{id}_3$$

By comparing (6-6) to (6-2) we thus, not surprisingly, get that $3 \cong 2 \oplus 1$.

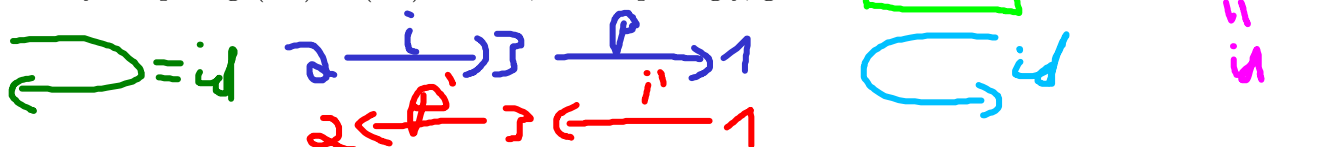

$$\mathbb{C}\{X\} \leftarrow \mathbb{C}\{1, X\} \rightarrow \mathbb{C}\{1\}$$

(b) A SES in $\text{Vec}_{\mathbb{C}}$ is

(6-7)

$$\begin{array}{ccc} \mathbb{C}\{X\} & \xleftarrow{X \mapsto X} & \mathbb{C}[X]/(X^2) \cong \mathbb{C}\{1, X\} \xrightarrow{1 \mapsto 1, X \mapsto 0} \mathbb{C}\{1\} \\ \mathbb{C}\{X\} & \xleftarrow{1 \mapsto 0, X \mapsto X} & \mathbb{C}[X]/(X^2) \cong \mathbb{C}\{1, X\} \xleftarrow{1 \mapsto 1} \mathbb{C}\{1\} \end{array}$$

$P \circ i = 0$

The bottom sequence is a splitting of the top, and thus $\mathbb{C}[X]/(X^2) \cong \mathbb{C}\{1\} \oplus \mathbb{C}\{X\}$.

There are a few things to check: First, we have to make sure that the used morphisms are in the correct category. (This sounds obvious, but is crucial: a lot of categories we will see are subcategories of $\text{Vec}_{\mathbb{k}}$, but not all \mathbb{k} linear maps are in general in such subcategories.) Second, we need to make sure that the left morphism is monic and the right morphisms epic. Third, we have to check $\text{Ker}(g) = \text{Im}(f)$. (All of this is easy to see for (6-5) and (6-7).)

Definition 6.50 A functor $F \in \text{Hom}_{\oplus}(\mathbb{C}, \mathbb{D})$ is called exact if

$$\left(X \xleftarrow{i} Y \xrightarrow{p} Z \text{ SES} \right) \Rightarrow \left(F(X) \xleftarrow{F(i)} F(Y) \xrightarrow{F(p)} F(Z) \text{ SES} \right)$$

As usual:

SES \rightarrow SES

Lemma 6.51 The identity functor on an additive category is exact. Moreover, if F and G are exact functors, then so is GF . \square

Example 6.52 We have a (non-dense, but full) subcategory $\text{Hom}_{\text{ex}}(\mathbb{C}, \mathbb{D}) \subset \text{Hom}_{\oplus}(\mathbb{C}, \mathbb{D})$, the category exact functors.

Exact functors are the correct functors between abelian categories:

Lemma 6.53 Let $F \in \text{Hom}_{\text{ex}}(\mathbb{C}, \mathbb{D})$ be a functor between abelian categories. Then:

Exact
good
for
ab.
cats!

(i) If $(X_i, f_i) \bullet \in \mathbb{C}$ is exact, then $(F(X_i), F(f_i)) \bullet \in \mathbb{D}$ is also exact.

(ii) If $(\text{Ker}(f), k) \in \mathbb{C}$ is a kernel, then $(F(\text{Ker}(f)), F(k)) \in \mathbb{D}$ is also a kernel. Similarly for cokernels.

(iii) If $(\text{Im}(f), m) \in \mathbb{C}$ is an image, then $(F(\text{Im}(f)), F(m)) \in \mathbb{D}$ is also an image. Similarly for coimages.

(iv) If f is monic, respectively epic, then $F(f)$ is monic, respectively epic.

(v) If

$$\text{ker}(f) \xrightarrow{k} X \xrightarrow{e} I \xrightarrow{m} Y \xrightarrow{c} \text{coker}(f)$$

\xrightarrow{f}

is an epic-monic factorization in \mathbb{C} , then

$$F(\text{ker}(f)) \xrightarrow{F(k)} F(X) \xrightarrow{F(e)} F(I) \xrightarrow{F(m)} F(Y) \xrightarrow{F(c)} F(\text{coker}(f))$$

$\xrightarrow{F(f)}$

is also an epic-monic factorization in \mathbb{D} .

Proof. (i). Note that being an exact sequence implies that we have

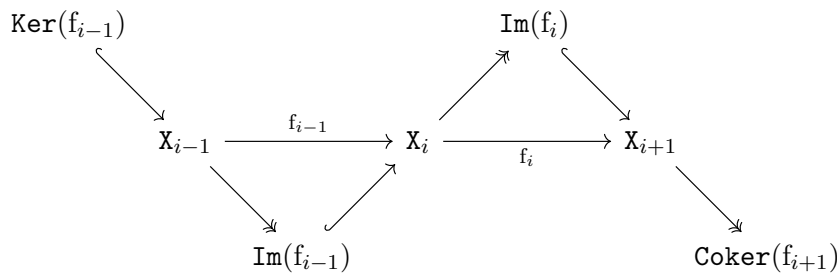

which commutes and has SES diagonals. Applying F yields a commuting diagram

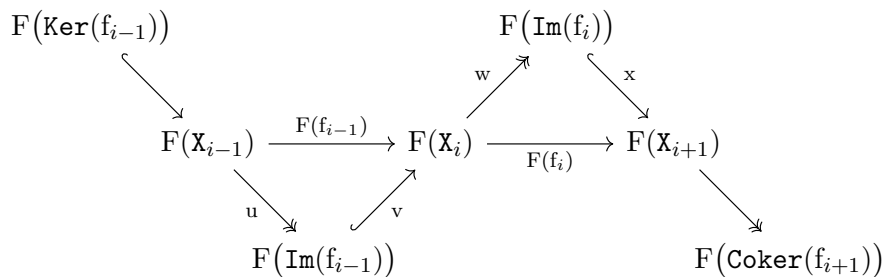

with still has SES diagonals. Then

$$\text{Im}(F(f_{i-1})) = \text{Im}(vu) = \text{Im}(v) = \text{Ker}(w) = \text{Ker}(xw) = \text{Ker}(F(f_i)),$$

shows the claim.

(ii). Kernels and cokernels are special cases of exact sequences.

(iii). We use (ii) and Lemma 6.36.(iii).

(iv). By (ii) and Lemma 6.31.(iii).

(v). Clear by the other statements. □

Example 6.54 We get a (non-full) subcategory $\text{Cat}_A \subset \text{Cat}_\oplus$, the category of abelian categories with morphisms being exact functors.

Definition 6.55 $C, D \in \text{Cat}_A$ are called equivalent as abelian categories, denoted by $C \simeq_e D$, if there exists an equivalence $F \in \text{Hom}_e(C, D)$.

Recall hom functors from Example 1.22, which will now again play a crucial role.

Example 6.56 As we have seen, any $C \in \text{Cat}_A$ is equivalent as an abelian category to some full subcategory of $\text{Mod}(A)$ for some appropriate ring A . The additive versions of the Yoneda embedding, cf. Proposition 1.56, almost do the job:

$$Y: C \rightarrow \text{Hom}_\oplus(C^{op}, \text{Vec}_{\mathbb{Z}}), \quad Y^{op}: C^{op} \rightarrow \text{Hom}_\oplus(C, \text{Vec}_{\mathbb{Z}})$$

is fully faithful, and thus, C is equivalent as an additive category to a full subcategory of right C modules. (Here we think of $\text{Hom}_\oplus(C^{op}, \text{Vec}_{\mathbb{Z}})$ as right C modules.) However, an SES is in

general not preserved since

$$(6-8) \quad \begin{aligned} \text{Hom}_{\mathbf{C}}(-, X) &\xrightarrow{\text{Hom}_{\mathbf{C}}(-, i)} \text{Hom}_{\mathbf{C}}(-, Y) \xrightarrow{\text{Hom}_{\mathbf{C}}(-, p)} \text{Hom}_{\mathbf{C}}(-, Z), \\ \text{Hom}_{\mathbf{C}}(X, -) &\xleftarrow{\text{Hom}_{\mathbf{C}}(i, -)} \text{Hom}_{\mathbf{C}}(Y, -) \xrightarrow{\text{Hom}_{\mathbf{C}}(p, -)} \text{Hom}_{\mathbf{C}}(Z, -), \end{aligned}$$

are not exact in the rightmost, respectively leftmost, position, even if one starts with an SES.

So the Yoneda embedding is not exact and does not prove [Theorem 6.44](#), at least not directly:

Proof. (Sketch of a proof of [Theorem 6.44](#).(i).) It is easy to see that $\text{Hom}_{\mathbf{C}}(-, X)$ is an additive and **right exact functor**, meaning that it sends a SES to a sequence as in the first row of (6-8), which is exact except at the far left. Such functors form a category $\mathbf{Hom}_{re}(\mathbf{C}^{op}, \mathbf{Vec}_{\mathbb{Z}})$, and one shows the following (non-trivial) statements:

- The category $\mathbf{Hom}_{re}(\mathbf{C}^{op}, \mathbf{Vec}_{\mathbb{Z}})$ is abelian.
- The adjusted Yoneda embedding $Y^{re}: \mathbf{C} \rightarrow \mathbf{Hom}_{re}(\mathbf{C}^{op}, \mathbf{Vec}_{\mathbb{Z}})$ with $X \mapsto \text{Hom}_{\mathbf{C}}(-, X)$ is additive exact and fully faithful.
- There exists an object $I \in \mathbf{Hom}_{re}(\mathbf{C}^{op}, \mathbf{Vec}_{\mathbb{Z}})$ whose endomorphism ring

$$A = \text{End}_{\mathbf{Hom}_{re}(\mathbf{C}^{op}, \mathbf{Vec}_{\mathbb{Z}})^{op}}(I)$$

provides an abelian category $\mathbf{Mod}(A)$ equivalent to $\mathbf{Hom}_{re}(\mathbf{C}^{op}, \mathbf{Vec}_{\mathbb{Z}})$ as an abelian category. \square

The projective, respectively injective, objects correct the “failure” in (6-8) (in fact, the object I from the above sketch of proof is a certain nice injective object called a **cogenerator**):

Definition 6.57 Let $\mathbf{C} \in \mathbf{Cat}_{\oplus}$.

(i) $P \in \mathbf{C}$ is called projective if we have

$$\text{Hom}_{\mathbf{C}}(P, -) \in \mathbf{Hom}_{ex}(\mathbf{C}, \mathbf{Vec}_{\mathbb{Z}}).$$

exact

(ii) $I \in \mathbf{C}$ is called injective if we have

$$\text{Hom}_{\mathbf{C}}(-, I) \in \mathbf{Hom}_{in}(\mathbf{C}^{op}, \mathbf{Vec}_{\mathbb{Z}}).$$

The following are (almost) immediate.



Lemma 6.58 If $\mathbf{C} \in \mathbf{Cat}_A$, then $P \in \mathbf{C}$ is projective if and only if it has the universal property of the form

$$\begin{array}{ccc} & P & \\ \exists! \swarrow u & \downarrow p & \\ Y & \xrightarrow{f} & X \end{array}$$

for any epic morphism p . Similarly for injective objects in abelian categories. \square

Lemma 6.59 Being projective is an additive property: two objects $P, P' \in \mathbf{C}$ are projective if and only if $P \oplus P'$ is projective. Similarly for injective objects. \square

Example 6.60 By Lemma 6.59 we have two additive full subcategories Proj(C), the category of projective objects, and Inj(C) the category of injective objects, for all $C \in \text{Cat}_A$.

Note also that we can define the same notions (projective, injective and their categories) for any $C \in \text{Cat}_\oplus$.

Definition 6.61 Let $C \in \text{Cat}_A$ and $X \in C$. We say $P(X) = (P(X), f: P(X) \twoheadrightarrow X)$ is a projective cover of X if $P(X)$ is projective and has the universal property of the form

$$(6-9) \quad \begin{array}{ccc} & P & \\ \exists! \swarrow u & \downarrow p & \\ P(X) & \dashrightarrow_f & X \end{array}, \quad \text{where } P \text{ is projective.}$$

An injective hull of f , denoted by $I(X) = (I(X), i: X \hookrightarrow I)$, is a projective cover of X in C^{op} .

The philosophy is a bit that every object is a quotient of a projective object and a subobject of an injective object, and the projective cover and the injective envelope are the universal objects achieving that. Thus, not surprisingly:

Lemma 6.62 Up to unique isomorphisms, $P(X)$ is the only object in C satisfying (6-9). Similarly for the injective hull. □

6J. The “elements” of additive and abelian categories. There are (at least) two competing ways to define “elements”: Either these are objects without substructure, called simple (the words “simple” is meant in the sense that they are “as simple as possible”, and not meaning they are easy). Or these are objects that can not be decomposed further, called indecomposable.

Definition 6.63 Let $C \in \text{Cat}_\oplus$.

(i) A non-zero object $L \in C$ is called simple if

$$(X \subset L) \Rightarrow (X = 0 \text{ or } X \cong L).$$

(ii) A non-zero object $Z \in C$ is called indecomposable if

$$Z \cong X \oplus Y \Rightarrow (X = 0 \text{ or } Y = 0).$$

We also say a decomposition $X' \cong X \oplus Y$ is non-trivial if neither X nor Y are zero. Similarly, a subobject $Y \subset X$ is non-trivial if it is neither 0 nor (isomorphic to) X .

Remark 6.64 Note that indecomposable means that an object has no non-trivial decomposition, while simple means that an object has no non-trivial subobjects.

The following lemma is clear and it enables us to define the set of simples $\text{Si}(C) \subset \text{Ob}(C)/\cong$ respectively indecomposables $\text{In}(C) \subset \text{Ob}(C)/\cong$ (up to isomorphism). We, abusing notation, write e.g. $L \in \text{Si}(C)$ for simplicity.

Lemma 6.65 The properties of being indecomposable or simple are preserved under isomorphisms. □

Note that being projective or injective is also preserved under isomorphism. Hence, by Lemma 6.59 we also have the sets of projective indecomposables $\text{Pi}(\mathbf{C}) \subset \text{Ob}(\mathbf{C})/\cong$ and injective indecomposables $\text{Ii}(\mathbf{C}) \subset \text{Ob}(\mathbf{C})/\cong$, respectively.

Lemma 6.66 Every simple object $L \in \mathbf{C}$ is indecomposable.

Proof. Clearly, any non-trivial decomposition $L \cong X \oplus Y$ gives non-trivial subobjects X and Y . \square

Example 6.67 Being simple or indecomposable depends on the ambient category, compare (6-10) and (6-12):

(a) For $\text{Vec}_{\mathbb{k}}$ it is easy to see that $\text{Si}(\text{Vec}_{\mathbb{k}}) = \text{In}(\text{Vec}_{\mathbb{k}}) = \text{Pi}(\text{Vec}_{\mathbb{k}}) = \text{Ii}(\text{Vec}_{\mathbb{k}}) = \{\mathbb{k}\}$. Thus, $A = \mathbb{C}[X]/(X^2) \in \text{Vec}_{\mathbb{C}}$ is neither simple nor indecomposable and we have

$$(6-10) \quad A \cong \mathbb{C} \oplus \mathbb{C}, \quad (\text{in } \text{Vec}_{\mathbb{C}}),$$

cf. (6-7). Moreover, every object in $\text{Vec}_{\mathbb{k}}$ is projective and injective.

(b) Consider now $A = \mathbb{C}[X]/(X^2)$ as a \mathbb{C} algebra. Then A acts on itself by multiplication, thus A can be seen as an object A of (the \mathbb{C} linear abelian category) $\text{Mod}(A)$. The \mathbb{C} algebra A also acts on \mathbb{C} via evaluation, and we hence have two objects $\mathbb{C}, A \in \text{Mod}(A)$. Choose $\{1, X\}$ as a basis of A . Looking at the action matrices on this basis gives

$$(6-11) \quad 1 \mapsto \begin{pmatrix} \boxed{1} & 0 \\ 0 & \boxed{1} \end{pmatrix}, \quad X \mapsto \begin{pmatrix} \boxed{0} & 0 \\ \boxed{1} & \boxed{0} \end{pmatrix}, \quad \begin{array}{l} \text{lower right block entry} \rightsquigarrow \mathbb{C}, \\ \text{upper left block entry} \rightsquigarrow \mathbb{C}. \end{array}$$

This shows that \mathbb{C} is a subobject of A (indicated in (6-11)), and hence A is not simple. However, the very same action matrices show that the complement space $\mathbb{C}\{1\}$ is not a subobject (the entry 1 in the lower left ruins this). However, one easily sees that A is (projective injective) indecomposable and

$$(6-12) \quad \underbrace{0 \subset \mathbb{C} = \mathbb{C} \subset A}_{\substack{\boxed{\mathbb{C}} \quad \boxed{\mathbb{C}}} } \not\cong \mathbb{C} \oplus \mathbb{C}, \quad (\text{in } \text{Mod}(A)),$$

$$\begin{array}{l} \text{Si} = \{\mathbb{C}\} \\ \text{Pi} = \{A\} = \text{Ii} \end{array}$$

with the right copy of \mathbb{C} being the upper left block entry and the left copy of \mathbb{C} being the lower right block entry in (6-11).

The difference between $\text{Vec}_{\mathbb{k}}$ and $\text{Mod}(A)$ is that the maps defining the decomposition from (6-10) are not A equivariant, i.e. they are not morphisms in $\text{Mod}(A)$. Precisely, we still have

$$\boxed{\mathbb{C}} \cong \mathbb{C}\{X\} \xleftarrow{X \mapsto X} \mathbb{C}[X]/(X^2) \xrightarrow{1 \mapsto 1, X \mapsto 0} \mathbb{C}\{1\} \cong \boxed{\mathbb{C}} \quad \text{SES},$$

but it does not split in contrast to (6-7).

Thus, Lemma 6.66 and Example 6.67 give:

indecomposable \Leftarrow simple,
indecomposable $\not\Leftarrow$ simple.

The following is known as Schur's lemma (or at least (i) of it).

Lemma 6.68 Let $C \in \text{Cat}_{\oplus}$.

(i) If \mathbf{C} has kernels and cokernels, then, for any $L, L' \in \text{Si}(\mathbf{C})$ with $L \not\cong L'$:

$\text{End}_{\mathbf{C}}(L)$ is a division ring, $\text{Hom}_{\mathbf{C}}(L, L') = 0.$

$f: L \rightarrow L'$
 $\left\{ \begin{array}{l} \text{is } L \cong L' \\ 0 \quad L \not\cong L' \end{array} \right.$

(ii) For any $Z \in \text{In}(\mathbf{C})$ we have

$\text{End}_{\mathbf{C}}(Z)$ is a local ring.

Proof. This is Exercise 6.96. □

Schur's lemma, part II:

Lemma 6.69 Let $\mathbf{C} \in \text{Cat}_{\mathbb{K}A}$ with \mathbb{K} being algebraically closed. Then, for any $L, L' \in \text{Si}(\mathbf{C})$ with $L \not\cong L'$, we have

(6-13) $\text{End}_{\mathbf{C}}(L) \cong \mathbb{K}, \text{Hom}_{\mathbf{C}}(L, L') = 0.$

Proof. This is also Exercise 6.96. □

Example 6.70 With respect to Example 6.67 we have

$A = \mathbb{C}[X]/X^2$

$\text{End}_{\text{Vec}_{\mathbb{C}}}(\mathbb{C}) \cong \mathbb{C} \cong \text{End}_{\text{Mod}(A)}(\mathbb{C}),$

$\text{End}_{\text{Vec}_{\mathbb{C}}}(\mathbb{C}[X]/(X^2)) \cong \text{Mat}_{2 \times 2}(\mathbb{C}), \text{End}_{\text{Mod}(A)}(\mathbb{C}[X]/(X^2)) \cong \mathbb{C}[X]/(X^2),$

and the idempotents $\begin{pmatrix} 1 & 0 \\ 0 & 0 \end{pmatrix}, \begin{pmatrix} 0 & 0 \\ 0 & 1 \end{pmatrix} \in \text{Mat}_{2 \times 2}(\mathbb{C})$ give the decomposition in (6-10).

Note that any ("finite") $X \in \mathbf{C}$ with $\mathbf{C} \in \text{Cat}_{\oplus}$, by definition, decomposes additively into indecomposables. However, Example 6.67 shows that it is too much to hope that X decomposes additively into simples. We rather need the analog of (6-12):

Definition 6.71 Assume that $\mathbf{C} \in \text{Cat}_{\oplus}$ has kernels and cokernels. For a non-zero $X \in \mathbf{C}$ a sequence of subobjects of the form

(6-14) $0 = X_0 \subset X_1 \subset \dots \subset X_{n-1} \subset X_n = X$

is called a filtration by simples or a composition series if $X_i/X_{i-1} \cong L_i \in \text{Si}(\mathbf{C})$. A non-zero $X \in \mathbf{C}$ is called of finite length if it has such a filtration, and in this case the appearing L_i are called the simple factors of X .

We stress that the main point in (6-14) is that successive quotients are simple:

$0 = \underbrace{X_0 \subset X_1}_{L_1} \subset \dots \subset \underbrace{X_{n-1} \subset X_n}_{L_n} = X.$

Definition 6.72 For a non-zero $X \in \mathbf{C}$ with $\mathbf{C} \in \text{Cat}_{\oplus}$ a decomposition of the form

(6-15) $X \cong Z_1 \oplus \dots \oplus Z_n$

is called a decomposition by indecomposables if $Z_i \in \text{In}(\mathbf{C})$. A non-zero $X \in \mathbf{C}$ is called of finite decomposition length if it has such a decomposition, and in this case the appearing Z_i are called the indecomposable summands of X .

Example 6.73 In Vec_k an object is of finite length if and only if it is finite dimensional. Moreover, for finite dimensional k vector spaces (6-14) and (6-15) agree.

The following theorem is our justification for using the analogy to elements in chemistry, where **Theorem 6.74**.(i) is known as the Jordan–Hölder theorem, and (ii) as the Krull–Schmidt theorem.

Simple

inde.

Theorem 6.74 Let $\mathbf{C} \in \text{Cat}_\oplus$.

- (i) Assume that $\mathbf{C} \in \text{Cat}_\oplus$ has kernels and cokernels. Let $X \in \mathbf{C}$ be of finite length. Then a filtration as in (6-14) is unique up to reordering and isomorphisms of subobjects.
- (ii) Let $X \in \mathbf{C}$ be of finite decomposition length. Then a decomposition as in (6-15) is unique up to reordering and isomorphisms of summands.

In particular, we can define the following numerical invariants of such X .

- The length $\ell(X)$ of X can be defined to be n in (6-14), and the decomposition length $d(X)$ of X can be defined to be n in (6-15).
- The multiplicities of L (simple) respectively Z (indecomposable) in X denoted by

$$[X : L] = \#\{i \mid X_i/X_{i-1} \cong L\}, \quad (X : Z) = \#\{i \mid Z_i \cong I\}.$$

- The sets

$$\left\{ \begin{array}{l} \{L, m \mid L \text{ is a simple factor of } X \text{ with multiplicity } m\}, \\ \{Z, m \mid Z \text{ is an indecomposable summand of } X \text{ with multiplicity } m\}. \end{array} \right.$$

Remark 6.75 We will use the notion “numerical” quite often and this is to be understood as reducing notions from categorical algebra to “something easier” such as classical algebra, combinatorics, linear algebra etc. Thus, a “numerical invariant” for us is not necessarily a number, but simply something that is “easier” than the problem at hand.

Proof. We only prove (i), the arguments for (ii) are similar. The proof works by induction over $n \geq 1$, with n being the smallest possible length of a filtration by simples. For $n = 1$ there is nothing to show since X is then itself simple. So assume that $n > 1$ and that we have two filtrations

$$\begin{aligned} 0 = X_0 \subset X_1 \subset \dots \subset X_{n-1} \subset X_n = X, & \quad \text{simple factors } L_1, \dots, L_n, \\ 0 = X'_0 \subset X'_1 \subset \dots \subset X'_{n'-1} \subset X'_{n'} = X, & \quad \text{simple factors } L'_1, \dots, L'_{n'}, \end{aligned}$$

with n being minimal. There are now two cases. First, if $X_1 \cong X'_1 \cong L_1 \cong L'_1$ we are done by induction since $X/X_1 \cong X/X'_1$ has a shorter filtration with simple factors being either L_i for $i = 2, \dots, n$, or L'_j for $j = 2, \dots, n'$, and we can use the induction hypothesis to see that these simples agree up to reordering and isomorphisms. Otherwise, $X_1 \not\cong X'_1$ and Schur’s lemma implies that $X_1 \oplus X'_1$ is a subobject of X and we can consider $Y = X/(X_1 \oplus X'_1)$. It is easy to see that Y has a filtration by simples, say with simple factors L_k^Y , for $k = 1, \dots, r < n$. We then observe that:

- X/X_1 has a filtration with simple factors X'_1, L_k^Y for $k = 1, \dots, r$, but also one with the original simple factors L_i except $X_1 \cong L_1$.

- X/X'_1 has a filtration with simple factors X_1, L_k^Y for $k = 1, \dots, r$, but also one with the original simple factors L'_j except $X'_1 \cong L'_1$.

By the induction assumption, this means that the collection of simples X_1, X'_1 and L_i^Y for $i = 1, \dots, r$ coincides (up to reordering and isomorphisms) on the one hand with L_i for $i = 1, \dots, n$ and on the other hand with the L'_j for $j = 1, \dots, n'$. \square

6K. Finiteness assumptions. For what will follow we need and want to go to the finite dimensional world:

Definition 6.76 Let $\mathbf{fdVec}_{\mathbb{Z}} \subset \mathbf{Vec}_{\mathbb{Z}}$ be the full subcategory of torsion free abelian groups of finite rank.

Without harm we can think of Definition 6.76 as being the \mathbb{Z} linear version of $\mathbf{fdVec}_{\mathbb{k}} \subset \mathbf{Vec}_{\mathbb{k}}$, and the “fd” refers to finite dimensional: having always an underlying field in mind, we say “finite dimensional” instead of the mouthful “torsion free of finite rank”.

Definition 6.77 Let $\mathbf{C} \in \mathbf{Cat}_{\oplus}$, and assume that $\mathbf{Hom}_{\mathbf{C}}(X, Y) \in \mathbf{fdVec}_{\mathbb{Z}}$ for all $X, Y \in \mathbf{C}$.

- (i) If \mathbf{C} is abelian and any $X \in \mathbf{C}$ is of finite length, then we call \mathbf{C} locally (abelian) finite.
- (ii) If any $X \in \mathbf{C}$ has a decomposition as in (6-15) satisfying the Krull-Schmidt theorem Theorem 6.74.(ii), then we say that \mathbf{C} is locally additively finite.

Example 6.78 Here are some prototypical examples:

- (a) Not all objects in $\mathbf{Vec}_{\mathbb{k}}$ have finite length and hom spaces are not finite dimensional, thus $\mathbf{Vec}_{\mathbb{k}}$ is not locally finite. ~~X~~
- (b) The full subcategory $\mathbf{fdVec}_{\mathbb{k}} \subset \mathbf{Vec}_{\mathbb{k}}$ is locally finite. ✓
- (c) For any group (it may be infinite) G and any ω , the category $\mathbf{Vec}_{\mathbb{k} \oplus}^{\omega}(G)$ is locally finite, because in the additive closure we only allow finite direct sums. ✓

Note that we have

$$\begin{aligned} & \left. \begin{aligned} & \text{locally additively finite} \Leftarrow \text{locally (abelian) finite,} \\ & \text{locally additively finite} \not\Leftarrow \text{locally (abelian) finite,} \end{aligned} \right\} \end{aligned}$$

the latter being justified by Example 6.81. Before we can state it, we need the analog of Definition 6.42 in this finite setting:

Definition 6.79 An algebra A in $\mathbf{fdVec}_{\mathbb{Z}}$ is called a finite dimensional algebra. The category of finite dimensional right A modules for such an algebra is defined to be $\mathbf{fdMod}(A) = \mathbf{Mod}_{\mathbf{fdVec}_{\mathbb{Z}}}(A)$. We also have full subcategories $\mathbf{fdProj}(A) \subset \mathbf{fdMod}(A)$ and $\mathbf{fdInj}(A) \subset \mathbf{fdMod}(A)$ of finite dimensional projectives and finite dimensional injectives, respectively.

Definition 6.80 For any algebra $A \in \mathbf{Vec}_{\mathbb{Z}}$ let $\mathbf{fdMod}(A) = \mathbf{Mod}_{\mathbf{fdVec}_{\mathbb{Z}}}(A) \subset \mathbf{Mod}_{\mathbf{Vec}_{\mathbb{Z}}}(A)$ denote the corresponding full subcategory of **finite dimensional modules**. Similarly for finite dimensional projective and injective modules.

$$A = \mathbb{C}[x] / x^2$$

Example 6.81 Let us come back to [Example 6.67](#). The $\mathbb{C}, A \in \mathbf{fdMod}(A)$, and $\mathbf{fdMod}(A)$ is locally finite. However, \mathbb{C} is neither projective nor injective. Hence, A does not have any composition series in terms of projectives or injectives. Thus, neither $\mathbf{fdProj}(A)$ nor $\mathbf{fdInj}(A)$ are locally finite, but one can show that both are locally additively finite.

The following are the abelian categories which we will use most of the time.

Definition 6.82 A category $\mathbf{C} \in \mathbf{Cat}_A$ is called (abelian) **finite** if

- \mathbf{C} is locally finite;
- the set $\text{Si}(\mathbf{C})$ is finite;
- every simple $L \in \mathbf{C}$ has a projective cover.

For any such \mathbf{C} we have the full subcategories $\mathbf{fProj}(\mathbf{C})$ and $\mathbf{fInj}(\mathbf{C})$ of **finite projective** respectively **finite injective objects**. We also have the **category of finite abelian categories** being the corresponding full subcategory $\mathbf{Cat}_{fA} \subset \mathbf{Cat}_A$.

Example 6.83 Back to [Example 6.78](#):

- (a) The abelian category $\mathbf{fdVec}_{\mathbb{k}}$ is finite.
- (b) For any group G and any ω , the abelian category $\mathbf{Vec}_{\mathbb{k} \oplus}^{\omega}(G)$ is finite if and only if G is finite.

We have already seen the explicit description of finite abelian categories, see [Theorem 6.44](#).(ii). We now sketch a proof.

Proof. (Sketch of a proof of [Theorem 6.44](#).(ii).) Since $\text{Si}(\mathbf{C})$ is finite by assumption, we can number the simples therein L_i for $i = 1, \dots, n$. Also by assumption, they have projective covers $P_i = P(L_i)$. Take

$$A = \text{End}_{\mathbf{C}}\left(\bigoplus_{i=1}^n P_i\right),$$

with $\bigoplus_{i=1}^n P_i$ usually called a **projective generator**. Note that A is finite dimensional because the hom spaces are, again by assumption, finite dimensional. Also $\mathbf{fdMod}(A)$ is finite abelian, by classical representation theory. It is then not hard to see that this is the category we need, i.e.

$$\text{Hom}_{\mathbf{C}}\left(\bigoplus_{i=1}^n P_i, -\right): \mathbf{C} \xrightarrow{\simeq} \mathbf{fdMod}(A) .$$

Note hereby that the hom functor is exact since $\bigoplus_{i=1}^n P_i$ is projective. Finally, $\text{Hom}_{\mathbf{C}}\left(\bigoplus_{i=1}^n P_i, X\right)$ for all $X \in \mathbf{C}$ is a right A module via precomposition. \square

Remark 6.84 Let $\mathbf{C} \subset \mathbf{Cat}_{fA}$. Note that the indecomposable projectives in $\mathbf{fProj}(\mathbf{C})$ are the projective covers of the simples in \mathbf{C} , while the indecomposable injectives in $\mathbf{fInj}(\mathbf{C})$ are their

injective hulls. In particular,

$$\#Si(\mathbf{C}) = \#Pi(\mathbf{C}) = \#Ii(\mathbf{C}).$$

In fact, in view of the Freyd–Mitchell theorem [Theorem 6.44\(ii\)](#), as a right A module

$$(6-16) \quad A \cong \bigoplus_{i=1}^n \dim(L_i)P_i$$

Example 6.85 Let us discuss the above proof in two examples.

(a) In $\mathbf{fdVec}_{\mathbb{k}}$ a projective generator is for example \mathbb{k} and $\text{End}_{\mathbf{fdVec}_{\mathbb{k}}}(\mathbb{k}) \cong \mathbb{k}$, so that $\mathbf{fdVec}_{\mathbb{k}} \simeq_e \mathbf{fdMod}(\mathbb{k})$. However, $\mathbb{k} \oplus \mathbb{k}$ is also a projective generator and in this case one gets $\mathbf{fdVec}_{\mathbb{k}} \simeq_e \mathbf{fdMod}(\text{Mat}_{2 \times 2}(\mathbb{k}))$.

(b) In [Example 6.67](#) the only simple object is \mathbb{C} itself, and $P(\mathbf{C}) = A$. Clearly the corresponding algebra $A = \text{End}_{\mathbf{fdMod}(\mathbb{C}[X]/(X^2))}(P(\mathbf{C}))$ is isomorphic to $\mathbb{C}[X]/(X^2)$.

These are, of course, rather boring examples as the abelian categories already are of the form $\mathbf{fdMod}(A)$. However, what we want to stress is that the above proof is a generalization of the fact that every monoid M is isomorphic to the monoid $\text{End}_{\mathbf{M}}(M)$, which we have already seen in the proof of [Theorem 2.32](#).

Finally, recall the Grothendieck classes, see [Definition 1.44](#).

Definition 6.86 Let $\mathbf{C} \in \mathbf{Cat}_{fA}$, and let $\mathbf{D} = \mathbf{C}$ or $\mathbf{D} \in \{\mathbf{fProj}(\mathbf{C}), \mathbf{fInj}(\mathbf{C})\}$.

(i) We endow $K_0(\mathbf{C})$ with the structure of an abelian group via

$$([Y] = [X] + [Z]) \Leftrightarrow (\exists X \xrightarrow{i} Y \xrightarrow{p} Z \text{ SES}).$$

(ii) We endow $K_0(\mathbf{D})$ with the structure of an abelian group via

$$([Y] = [X] + [Z]) \Leftrightarrow (Y \cong X \oplus Z).$$

In order to distinguish the two structures we write $K_0^e(-)$ for the one involving SES and $K_0^\oplus(-)$ for the additive version.

The following are easy and omitted.

Lemma 6.87 Let $\mathbf{C} \in \mathbf{Cat}_{fA}$, and let $\mathbf{D} \in \{\mathbf{Cat}_{fA}, \mathbf{fProj}(\mathbf{C}), \mathbf{fInj}(\mathbf{C})\}$. Enumerate the simples in \mathbf{C} or \mathbf{D} by L_i for $i = 1, \dots, n$, and let P_i and I_i for $i = 1, \dots, n$ be their respective projective covers or injective hulls. Then:

(i) [Definition 6.86](#) endows $K_0^e(\mathbf{C})$ and $K_0^\oplus(\mathbf{D})$ with the structures of finite dimensional abelian groups.

(ii) The set $Si(\mathbf{C})$ is a basis of $K_0^e(\mathbf{C})$. We have

$$[X] = \sum_{i=1}^n [X : L_i] \cdot [L_i] \in K_0^e(\mathbf{C}).$$

(iii) The sets $Pi(\mathbf{D})$ and $Ii(\mathbf{D})$ are bases of $K_0^\oplus(\mathbf{D})$. We have

$$[X] = \sum_{i=1}^n (X : P_i) \cdot [P_i] \in K_0^\oplus(\mathbf{D}),$$

and similarly with injectives. □

Lemma 6.88 Let $\mathbf{C}, \mathbf{C}' \in \mathbf{Cat}_{fA}$, and let $\mathbf{D}, \mathbf{D}' \in \{\mathbf{Cat}_{fA}, \mathbf{fProj}(\mathbf{C}), \mathbf{fInj}(\mathbf{C})\}$.

(i) Any functor $F \in \mathbf{Hom}_e(\mathbf{C}, \mathbf{C}')$ induces a group homomorphism

$$K_0^e(F): K_0^e(\mathbf{C}) \rightarrow K_0^e(\mathbf{C}').$$

Further, if F is an equivalence, then $K_0^e(F)$ is an isomorphism.

(ii) Any functor $F \in \mathbf{Hom}_\oplus(\mathbf{D}, \mathbf{D}')$ induces a group homomorphism

$$K_0^\oplus(F): K_0^\oplus(\mathbf{D}) \rightarrow K_0^\oplus(\mathbf{D}').$$

Further, if F is an equivalence, then $K_0^\oplus(F)$ is an isomorphism. □

The final definition in this section which is well-defined by Lemma 6.87.

Definition 6.89 Keeping the notation from Lemma 6.87, the **projective and injective Cartan matrices** are the $n \times n$ matrices

$$C_p(\mathbf{C}) = ([P_i : L_j])_{i,j=1}^n, \quad C_i(\mathbf{C}) = ([I_i : L_j])_{i,j=1}^n.$$

Let us finish this subsection with a bigger example. Before that, let us recall:

Remark 6.90 Let $p' \in \mathbb{N}$ be a prime and $n \in \mathbb{N}_{>0}$. Recall that there exist a unique, up to isomorphism, finite field \mathbb{F}_q of order $q = (p')^n$ explicitly constructed by:

- If $n = 1$, then $\mathbb{F}_{p'} = \mathbb{Z}/p'\mathbb{Z}$;
- if $n > 1$, then $\mathbb{F}_q = \mathbb{F}_{p'}[X]/(X^q - X)$.

The algebraic closure of \mathbb{F}_q is $\overline{\mathbb{F}}_q = \bigcup_{m \in \mathbb{N}_{>0}} \mathbb{F}_{q^m}$. (Finite fields can not be algebraically closed by the folk argument: "If $\mathbb{F} = \{z_1, \dots, z_r\}$, then $p(X) = 1 + \prod_{i=1}^r (X - z_i)$ has no root in \mathbb{F} ".)

Let further $m \in \mathbb{N}_{>0}$ and consider the polynomial $p(X) = X^m - 1$. Then:

(6-17) $p(X)$ has $\gcd(m, q - 1)$ roots in \mathbb{F}_q .

In particular, if $m = p$ is itself a prime, then there are primitive m th root of unity in $\overline{\mathbb{F}}_{p'}$ if and only if $p \neq p'$. Explicitly, and easy to generalize, if $p = 5$, $k \in \mathbb{N}_{>0}$ and $p' = 5$ or $p' = 7$, then

$$\gcd(5, 5^k - 1) = 1, \quad \gcd(5, 7^k - 1) = \begin{cases} 5 & \text{if } k \equiv 0 \pmod{p-1}, \\ 1 & \text{else.} \end{cases}$$

\mathbb{F}_5 $[\mathbb{F}_5]$

Example 6.91 Let us consider $A = \overline{\mathbb{F}}_5[\mathbb{Z}/5\mathbb{Z}]$ and let $\mathbf{C} = \mathbf{fdMod}(A)$.

As already stated, see Remark 6.84, the sets $\mathbf{Si}(\mathbf{C})$, $\mathbf{Pi}(\mathbf{C})$ and $\mathbf{Ii}(\mathbf{C})$ have all the same size in general, while $\mathbf{In}(\mathbf{C})$ might be bigger. Let us see this explicitly.

For A we can determine a module structure on a $\overline{\mathbb{F}}_5$ vector space by specifying the action of the generator $1 \in \mathbb{Z}/5\mathbb{Z}$ since $\mathbb{Z}/5\mathbb{Z} \cong \langle s \mid s^5 = 1 \rangle$ and the isomorphism is given by sending 1 to s .

We define five modules

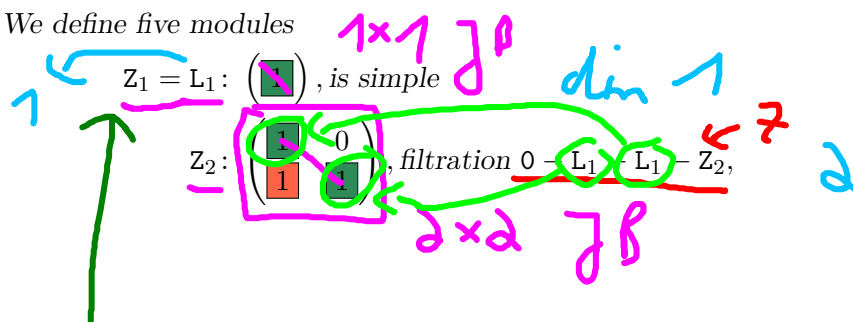

$Z_3: \begin{pmatrix} 1 & 0 & 0 \\ 1 & 1 & 0 \\ 0 & 1 & 1 \end{pmatrix}, \text{filtration } 0 - L_1 - L_1 - L_1 - Z_3,$
 $Z_4: \begin{pmatrix} 1 & 0 & 0 & 0 \\ 1 & 1 & 0 & 0 \\ 0 & 1 & 1 & 0 \\ 0 & 0 & 1 & 1 \end{pmatrix}, \text{filtration } 0 - L_1 - L_1 - L_1 - L_1 - Z_4,$
 $Z_5 = P_1: \begin{pmatrix} 1 & 0 & 0 & 0 & 0 \\ 1 & 1 & 0 & 0 & 0 \\ 0 & 1 & 1 & 0 & 0 \\ 0 & 0 & 1 & 1 & 0 \\ 0 & 0 & 0 & 1 & 1 \end{pmatrix}, \text{filtration } 0 - L_1 - L_1 - L_1 - L_1 - L_1 - Z_5,$

$\text{Si}(\mathbf{C}) = \{L_1\}, \text{Pi}(\mathbf{C}) = \{P_1\} = \text{Ii}(\mathbf{C}), \text{In}(\mathbf{C}) = \{Z_1, Z_2, Z_3, Z_4, Z_5\},$
 $K_0^e(\mathbf{C}) \cong K_0^\oplus(\mathbf{fProj}(\mathbf{C})) \cong K_0^\oplus(\mathbf{fInj}(\mathbf{C})) \cong \mathbb{Z}.$

$P_1 \cong \#_5 [Z/5]$

where we gave the action matrices of 1 and the filtrations by simples, where we give the successive simple quotients. In this case the characteristic 5 version of the Jordan theorem gives

$$\text{Si}(\mathbf{C}) = \{L_1\}, \text{Pi}(\mathbf{C}) = \{P_1\} = \text{Ii}(\mathbf{C}), \text{In}(\mathbf{C}) = \{Z_1, Z_2, Z_3, Z_4, Z_5\},$$

$$K_0^e(\mathbf{C}) \cong K_0^\oplus(\mathbf{fProj}(\mathbf{C})) \cong K_0^\oplus(\mathbf{fInj}(\mathbf{C})) \cong \mathbb{Z}.$$

However, the evident group homomorphism

$$K_0^\oplus(\mathbf{fProj}(\mathbf{C})) \rightarrow K_0^e(\mathbf{C}), [X] \mapsto [X] \leftrightarrow \mathbb{Z} \rightarrow \mathbb{Z}, 1 \mapsto 5,$$

is not a group isomorphism since $[P_1] = 5[L_1]$ in $K_0^e(\mathbf{C})$, and it corresponds, as indicated, to multiplication by 5. We also have $C_p(\mathbf{C}) = (5)$. Similarly for the injectives.

6L. Exercises.

Exercise 6.92 Show that the two morphisms

$$e_+ = \frac{1}{2} \cdot \left(\begin{array}{c|c} | & + \times \end{array} \right), \quad e_- = \frac{1}{2} \cdot \left(\begin{array}{c|c} | & - \times \end{array} \right),$$

are orthogonal idempotents in $\mathbf{Br}_{\mathbb{Q}^\oplus}$, meaning that $e_\pm^2 = e_\pm$ and $e_+e_- = 0$.

Exercise 6.93 Prove Proposition 6.25 and Lemma 6.36.

Exercise 6.94 Describe (co)kernels, images, the epic-monic factorizations, simples, projective and injectives in $\mathbf{Vec}_{\mathbb{k}^\oplus}(G)$. Moreover, find a presenting algebra A, cf. Theorem 6.44.

Exercise 6.95 Prove Schur's lemma(s) Lemma 6.68 and Lemma 6.69, and find an example for $\mathbb{k} = \mathbb{Q}$ where (6-13) does not hold.

Exercise 6.96 For $a, b, c \in \mathbb{C}$ let $A = \mathbb{C}[X]/(X - a)(X - b)(X - c)$. Consider the cases (a) $a = b = c = 0$, (b) $a = b = 0, c = 2$ and (c) $a = 0, b = 1, c = 2$ and show (e.g. via the Chinese remainder theorem) that

$$A \cong \begin{cases} \mathbb{C}[X]/(X^3) & \text{case (a),} \\ \mathbb{C}[X]/(X^2) \oplus \mathbb{C}[X]/(X - 2) & \text{case (b),} \\ \mathbb{C}[X]/(X) \oplus \mathbb{C}[X]/(X - 1) \oplus \mathbb{C}[X]/(X - 2) & \text{case (c),} \end{cases}$$

(What could the general statement for $\mathbb{C}[X]/\prod_{i=1}^n (X - a_i)$ be?) Then compute the Cartan matrix of $\text{fdMod}(A)$ in the above cases.

7. FIAT AND TENSOR CATEGORIES – ENRICH THE CONCEPTS FROM BEFORE

Recall that the Grothendieck classes of an additive or abelian category have an addition. So, in some sense, they categorify abelian groups. Thus, a natural question would be:

What are suitable categorifications of ring or algebras?

7A. **A word about conventions.** We keep the previous conventions and use additionally:

Convention 7.1 From now on we have categories with several structures, and we “stack” the notation; being careful with the hierarchy of the notions. For example, $\mathbf{C} \in \mathbf{RCat}_{\mathbb{k}A}$ means that \mathbf{C} is a rigid (for which \mathbf{C} needs to be monoidal) \mathbb{k} linear abelian (for which \mathbf{C} needs to be additive) category.

Convention 7.2 Note that “topological properties” of categories are usually written in front e.g. \mathbf{RCat} means rigid categories, while “algebraic properties” are usually in subscripts, e.g. \mathbf{Cat}_{lA} means locally finite abelian categories.

Convention 7.3 We tend to drop the “up to isomorphism” if no confusion can arise. For example, “has one simple” is to be read as “has one simple up to isomorphism”.

Convention 7.4 We write $k \cdot X$ short for $X \oplus \dots \oplus X$ (k summands). We also use the symbol $X \in Y$ for “ X is isomorphic to a direct summand of Y ”.

7B. **“The philosophy of idempotents.”** Before we can answer the main question of this section, we want to be able to take Grothendieck classes of a bigger class of categories. To this end, here is some motivation.

First, let us come back to (6-2), say for $\mathbf{Vec}_{\mathbb{k}}$. We write $e_X = i_X p_X$ and $e_Y = i_Y p_Y$. Let us also write $Z = X \oplus Y$. There are now several crucial observations:

- We have $e_Y = \text{id}_Z - e_X$, and $\text{Im}(e_X) \cong X$ and $\text{Im}(\text{id}_Z - e_X) \cong Y$.
- We have idempotency, i.e.

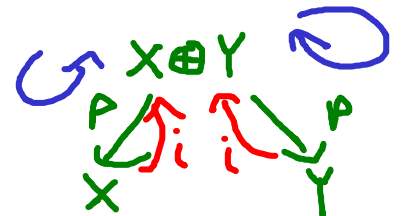

(7-1) $e_X^2 = e_X, \quad (\text{id}_Z - e_X)^2 = \text{id}_Z^2 - 2e_X + e_X^2 = \text{id}_Z - e_X.$

The property in (7-1) means that e_X is an idempotent. We also have

(7-2) $e_X(\text{id}_Z - e_X) = e_X - e_X^2 = 0 = e_X - e_X^2 = (\text{id}_Z - e_X)e_X, \quad \leftarrow e_X e_Y = 0$

(7-3) $e_X + (\text{id}_Z - e_X) = \text{id}_Z, \quad e_X + e_Y = 1$

with (7-2) and (7-3) being called orthogonality and completeness, respectively.

- We calculate that we have a commuting diagram

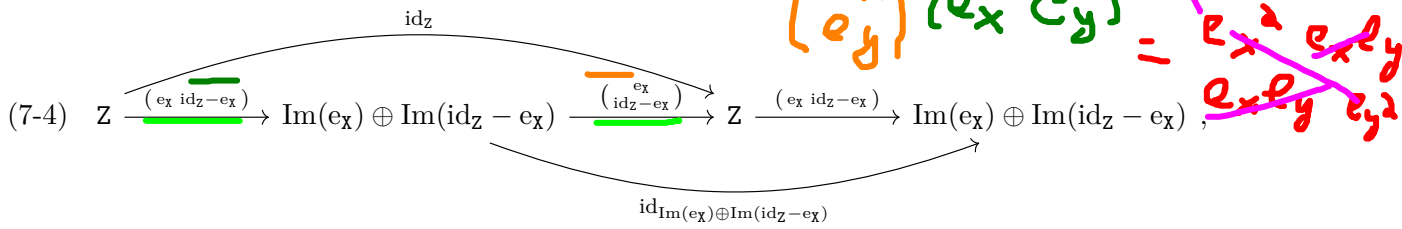

which implies that $Z \cong \text{Im}(e_x) \oplus \text{Im}(\text{id}_Z - e_x)$. The isomorphisms, in the corresponding directions, are the two matrices in (7-4).

- Note also that the above works both ways: Having a decomposition $Z \cong X \oplus Y$ we get the idempotent e_x satisfying all the above properties. Conversely, having an idempotent $e: Z \rightarrow Z$ we get a diagram as in (7-4).
- The algebra above is very basic and only uses the existence of images and no other specific properties of Vec_k . *Good*

All of this together is called “The philosophy of idempotents,” i.e. idempotents decompose objects into direct sums. This is, of course, most useful if the object one might care about does not come directly as $X \oplus Y$, but rather in some disguise. Here we do not want to take the trivial idempotents 0 and id_Z , and idempotents not of this form are called non-trivial.

Example 7.5 Let $A = \mathbb{C}[X]/(X^2)$ and $B = \mathbb{C}[X]/(X^2 - 1)$. We claim that these are quite different algebras in the following sense. An element in either A or B is of the form $a + bX = a \cdot 1 + b \cdot X$, where $a, b \in \mathbb{C}$. We calculate that

$$(a + bX)^2 = a^2 + 2abX + b^2X^2 = \begin{cases} a^2 + 2abX & \text{in A,} \\ a^2 + b^2 + 2abX & \text{in B.} \end{cases}$$

Thus, trying to solve the equation $(a + bX)^2 = a + bX$ for A gives only the trivial solutions $a = b = 0$ and $a = 1, b = 0$, and hence there is no non-trivial idempotent in A. In contrast, in B we get two non-trivial solutions

$$e_+ = \frac{1}{2}(1 + X), \quad e_- = \frac{1}{2}(1 - X),$$

$$e^2 = e$$

which satisfy (7-1), (7-2) and (7-3). Thus, as \mathbb{C} algebras, we get:

$$\mathbb{C}[X]/(X^2 - 1) \cong \text{Im}(e_+) \oplus \text{Im}(e_-) \cong \mathbb{C}[X]/(1 + X) \oplus \mathbb{C}[X]/(1 - X) \cong \mathbb{C} \oplus \mathbb{C}.$$

for any C

7C. The idempotent closure. The above says that we might want images, but we only need them for idempotents.

Definition 7.6 The idempotent closure of $\mathbb{C} \in \text{Cat}$, denoted by \mathbb{C}_ϵ is the category with

- objects being pairs

$$\text{Ob}(\mathbb{C}_\epsilon) = \{(X, e) \mid X \in \mathbb{C}, e: X \rightarrow X \text{ idempotent}\};$$

(X, e)

- morphisms being $f: (X, e) \rightarrow (Y, e')$ with $(f: X \rightarrow Y) \in \mathbf{C}$ such that we have a commuting diagram

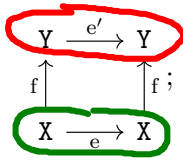

- the identities are $\text{id}_{(X,e)} = e$;
- composition is composition in \mathbf{C} .

Good news, this works well:

Proposition 7.7 Let $\mathbf{C} \in \mathbf{Cat}$. Then we have:

(i) \mathbf{C}_ϵ is a category. ✓

(ii) There exists a well-defined fully faithful functor

$$K: \mathbf{C} \rightarrow \mathbf{C}_\epsilon, X \mapsto (X, \text{id}_X), f \mapsto f.$$

$$X \mapsto (X, \text{id}_X)$$

(iii) If $e \in \mathbf{C}$ is an idempotent, then it has an image $\text{Im}(e) \cong (X, e)$ in \mathbf{C}_ϵ .

(iv) We have $\mathbf{C}_\epsilon \simeq (\mathbf{C}_\epsilon)_\epsilon$ and one can find an equivalence preserving images of idempotents.

(v) If $\mathbf{C} \in \mathbf{Cat}$ is \mathbb{S} linear (or additive or monoidal or rigid or pivotal or braided etc.), then so is \mathbf{C}_ϵ with its structure induced from \mathbf{C} .

(The notation K comes from the alternative name of \mathbf{C}_ϵ : it is sometimes called **Karoubi completion**.)

Proof. We only prove (iii), the rest is [Exercise 7.58](#). To see that $\text{Im}(e) \cong (X, e)$ we just observe that

$$\begin{array}{ccc}
 (X, e) & & \\
 e \downarrow & \searrow e & \\
 (X, e) & \xrightarrow{e} & (X, e)
 \end{array}$$

commutes, since e is an idempotent and $e = \text{id}_{(X,e)}$. □

We use [Proposition 7.7](#).(iii) to write $\text{Im}(e)$ for the objects of \mathbf{C}_ϵ , and we also write X instead of (X, id_X) . Moreover, we call a category \mathbf{C} **idempotent complete** if $\mathbf{C} \simeq \mathbf{C}_\epsilon$. Let us also write $\mathbf{C}_{\mathbb{k}\epsilon} = (\mathbf{C}_{\mathbb{k}})_\epsilon$ etc.

Example 7.8 The idempotent closures is a technology for non-module-like categories:

- (a) We have $\mathbf{Vec}_{\mathbb{k}} \simeq_e \mathbf{Vec}_{\mathbb{k}\epsilon}$, which is thus idempotent complete. The same is true for any abelian category, or any category having images.
- (b) Categories of the form $\mathbf{fdMod}(A)$, $\mathbf{fProj}(\mathbf{Mod}(A))$ or $\mathbf{fInj}(\mathbf{Mod}(A))$ for a finite dimensional algebra A are idempotent complete.

(c) Categories of the form $\mathbf{Vec}_{\mathbb{k} \oplus}^\omega(G)$ are idempotent complete.

Example 7.9 Diagrammatic categories are almost never idempotent complete and we like to think about the idempotent completion of them as **coloring with idempotents**: Recall the category **Sym**, see [Example 3.21](#), and let us make it \mathbb{Q} linear additive. Then

$$e_+ = \frac{1}{2} \cdot \left(\begin{array}{c} | \\ | \\ + \\ \times \end{array} \right), \quad e_- = \begin{array}{c} | \\ | \\ - \\ e_+ \end{array} = \frac{1}{2} \cdot \left(\begin{array}{c} | \\ | \\ - \\ \times \end{array} \right),$$



are orthogonal and complete idempotents in $\mathbf{Sym}_{\mathbb{Q} \oplus}$, see also [Exercise 6.92](#). Thus,

$$(7-5) \quad \bullet \bullet \cong \text{Im}(e_+) \oplus \text{Im}(e_-), \quad (\text{in } \mathbf{Sym}_{\mathbb{Q} \oplus \epsilon}).$$

We can think of this as coloring the diagrams with the idempotents e_+ and e_- , illustrated say red (and dashed) and green, and (7-5) becomes

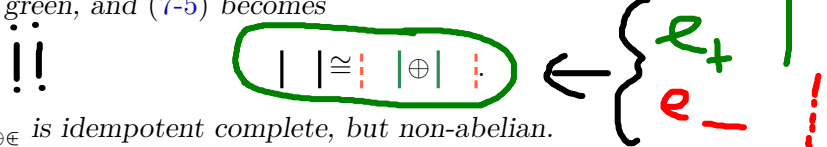

Note that $\mathbf{Sym}_{\mathbb{Q} \oplus \epsilon}$ is idempotent complete, but non-abelian.

Remark 7.10 [Example 7.8\(a\)](#) and [Example 7.9](#) show that, for additive categories,

idempotent complete \Leftarrow abelian,
 idempotent complete $\not\Rightarrow$ abelian.

Here is the analog of [Proposition 6.26](#).

Proposition 7.11 Let $F \in \mathbf{Hom}(C, D)$. Then there exists a unique $F_\epsilon \in \mathbf{Hom}(C_\epsilon, D_\epsilon)$ such that we have a commuting diagram

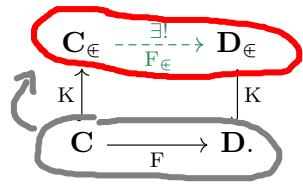

\oplus good

Proof. The functor F_ϵ is defined by

$$F_\epsilon: C_\epsilon \rightarrow D_\epsilon \quad (X, e) \mapsto (F(X), F(e)), f \mapsto F(f),$$

which satisfies all required properties. □

As for \mathbb{S} linear extensions and additive closures, as one can check, “all properties we care about behave nicely with idempotent closures”, e.g. if $F \in \mathbf{Hom}_\otimes(C, D)$, then so is $F_\epsilon \in \mathbf{Hom}_\otimes(C_\epsilon, D_\epsilon)$. In particular, we basically get direct sum decompositions for free:

Lemma 7.12 Let $C \in \mathbf{Cat}_\oplus$. Then

$$X \cong \text{Im}(e) \oplus \text{Im}(\text{id}_X - e)$$

holds in C_ϵ .

Proof. The proof is verbatim (7-4). □

Example 7.13 Being idempotent complete is a property, and thus, additive functors are the correct maps between additive idempotent complete categories. Hence, we have the category of additive idempotent complete categories $\text{Cat}_{\oplus \epsilon}$.

\oplus

7D. Tensor and fiat categories. Before going on, we need the additive analog of Definition 6.82:

Definition 7.14 A category $\mathbf{C} \in \text{Cat}_{\oplus}$ is called (additively) finite if

- \mathbf{C} is locally additively finite;
- the set $\text{In}(\mathbf{C})$ is finite. fiat

Si tensor

We have the category of additively finite categories being the corresponding full subcategory $\text{Cat}_{f\oplus} \subset \text{Cat}_{\oplus}$.

The following are either additive or abelian categorifications of \mathbb{S} algebras, as we will see below. (The rigidity is strictly speaking not needed to categorify algebras, but it makes life easier.) Here “w=weakly”, “m=multi” and “l=locally”.

Definition 7.15 A category $\mathbf{C} \in \text{Cat}$ is called wml fiat (over \mathbb{S}) if

- $\mathbf{C} \in \text{RCat}_{\mathbb{S} \oplus \epsilon}$; rigid \mathbb{S} \oplus \oplus
- \mathbf{C} is locally additively finite in the sense of Definition 6.77.(b);
- The bifunctor \otimes is \mathbb{S} bilinear. $\otimes \cap \cup$

If additionally

- $\mathbf{C} \in \text{PCat}$, then we drop the “weakly”;
- $\text{End}_{\mathbf{C}}(\mathbb{1}) \cong \mathbb{S}$, then we drop the “multi”;
- \mathbf{C} is finite in the sense of Definition 7.14, then we drop the “locally”.

Definition 7.16 A category $\mathbf{C} \in \text{Cat}$ is called a wml tensor category (over \mathbb{S}) if

- $\mathbf{C} \in \text{RCat}_{\mathbb{S}A}$; rigid \mathbb{S} abelian
- \mathbf{C} is locally finite in the sense of Definition 6.77.(b);
- The bifunctor \otimes is \mathbb{S} bilinear.

$\otimes \cap \cup$

If additionally

- $\mathbf{C} \in \text{PCat}$, then we drop the “weakly”;
- $\text{End}_{\mathbf{C}}(\mathbb{1}) \cong \mathbb{S}$, then we drop the “multi”;
- \mathbf{C} is finite in the sense of Definition 6.82, then we drop the “locally”.

fiat $\leftrightarrow \mathbb{I}_n$

tensor \leftrightarrow simples

Remark 7.17 The above terminology is not linearly ordered. For example, a *wm fiat category* can not directly compared to an *l tensor category*. However, we clearly have e.g. that *w fiat* is a stronger notion than *wl fiat*.

Example 7.18 We have already seen plenty of examples:

- (a) The category \mathbf{fdVec}_k is a tensor category. More generally, the categories of the form $\mathbf{Vec}_{k\oplus}^\omega(G)$ are *l tensor categories*, where we can drop the *l* if and only if *G* is finite.
- (b) Closures of diagrammatic categories such as $\mathbf{Br}_{k\in}$ can be made into l fiat categories, see Section 7E, but not tensor categories.

Example 7.19 All of these should be thought of as generalizing $\mathbf{Mod}(A)$ for certain “nice” algebras *A*. “Nice” means roughly:

- Bialgebras, see Section 5I, endow $\mathbf{Mod}(A)$ with a monoidal structure; \otimes
- Hopf algebras, see Section 5J, provide the duality; $\cap \cup$
- finite dimensional algebras and finite dimensional modules provide the various finiteness conditions, see Section 7G. *finite*

Example 7.19 in words says that fiat and tensor categories should be thought of as generalizations of $\mathbf{fdMod}(k[G])$ for *G* being a finite group. Explicitly:

Example 7.20 Back to Example 6.91, the category $\mathbf{C} = \mathbf{fdMod}(\mathbb{F}_5[\mathbb{Z}/5\mathbb{Z}])$ is actually pivotal, which we will see completely explicitly in (7-14) below. Moreover, we have $\mathbb{Z}_5 = P_1$

(7-6) $\underline{Z_1 P_1} \cong \underline{P_1}, \quad \underline{Z_2 P_1} \cong \underline{2 \cdot P_1}, \quad \underline{Z_3 P_1} \cong \underline{3 \cdot P_1}, \quad \underline{Z_4 P_1} \cong \underline{4 \cdot P_1}, \quad \underline{Z_5 P_1} \cong \underline{5 \cdot P_1}, \quad \underline{(P_1)^*} \cong \underline{P_1},$

so $\mathbf{C}' = \mathbf{fdProj}(\mathbb{F}_5[\mathbb{Z}/5\mathbb{Z}])$ is also pivotal (without monoidal unit). The category \mathbf{C} is a tensor category with one simple and five indecomposables. In contrast, the category \mathbf{C}' is a fiat category without monoidal unit but with a pseudo idempotent instead:

$$P_1 P_1 \cong 5 \cdot P_1 \quad (\iff e^2 = 5e),$$

and with one indecomposable. Finally, \mathbf{C} itself is also a fiat category (by which we mean that we care about indecomposables rather than simples) with five indecomposables.

Note that we already know the right functors between fiat respectively tensor categories: such functors should be \mathbb{S} linear additive rigid respectively \mathbb{S} linear exact rigid. Hence:

Example 7.21 We have the category of fiat categories Fiat, objects being fiat categories and morphisms being \mathbb{S} linear additive rigid functors. We also have the category of tensor categories Ten, objects being fiat categories and morphisms being \mathbb{S} linear exact rigid functors. Finally, we also have the various versions adding the adjectives “weakly”, “multi” or “locally”.

For a *wm fiat category* \mathbf{C} , by definition, we know that the set $\text{In}(\mathbf{C})$ is finite, so we can enumerate and denote the indecomposables by $\underline{Z_i}$ for $i = 1, \dots, n$. Similarly, we let $\underline{L_i}$ for $i = 1, \dots, n$ denote the simples of a *wm tensor category*. $\int_n \int_i$

Lemma 7.22 *Let $\mathbf{C} \in \mathbf{wmlFiat}$. Then:*

(i) *The functors \otimes , $-^*$ and ${}^*_-$ are \mathbb{S} linear additive.*

(ii) *If $\mathbf{C} \in \mathbf{wlFiat}$ is \mathbb{k} linear, then $\mathbb{1} \in \text{In}(\mathbf{C})$.*

(iii) *If $\mathbf{C} \in \mathbf{wmFiat}$, then the functor $-^*$ induces a bijection*

(7-7)
$$\underbrace{-^* : \text{In}(\mathbf{C}) \xrightarrow{\cong} \text{In}(\mathbf{C})}_{\text{red circle}} \quad Z_i \mapsto Z_i^* = Z_j$$

*Similarly for ${}^*_-$.*

Proof. (i). Since \mathbb{k} linear implies additive, see Lemma 6.14, the claim is immediate.

(ii). Note that $\text{End}_{\mathbf{C}}(\mathbb{1}) \cong \mathbb{k}$ implies that $\mathbb{1}$ is indecomposable as its endomorphism \mathbb{k} algebra does not have any non-trivial idempotents.

(iii). This follows since the dualities are \mathbb{S} linear additive monoidal functors by (i), so the property of being indecomposable is preserved by them. Moreover, by Proposition 4.24, they are invertible, thus, induce bijections. □

Proposition 7.23 *Let $\mathbf{C} \in \mathbf{wmfFiat}$ or $\mathbf{C} \in \mathbf{wmfTen}$ and $\mathbf{X} \in \mathbf{C}$. Then $(\mathbf{X} \otimes -), (- \otimes \mathbf{X}) \in \text{End}_e(\mathbf{C})$.*

Proof. Since we have duals, we can use Theorem 4.16 to see that both functors have right and left adjoints (in the sense of Example 4.10). It is then not hard to see that such functors preserve the property of being a SES. □

Here is an interesting fact: projective and injective objects form a monoidal ideal (cf. (7-6) for an example – tensoring with a projective gives a projective) in the following sense.

Proposition 7.24 *Let $\mathbf{C} \in \mathbf{wmfFiat}$ or $\mathbf{C} \in \mathbf{wmfTen}$. Let further $\mathbf{P} \in \text{Proj}(\mathbf{C})$ and $\mathbf{X} \in \mathbf{C}$. Then $\mathbf{PX}, \mathbf{XP} \in \text{Proj}(\mathbf{C})$. Similarly for injective objects.*

Proof. Using Theorem 4.16 we get e.g.

$$\text{Hom}_{\mathbf{C}}(\mathbf{PX}, \mathbf{Y}) \cong \text{Hom}_{\mathbf{C}}(\mathbf{P}, \mathbf{Y}(\mathbf{X}^*)),$$

which shows, using Proposition 7.23, that the hom functor for \mathbf{PX} is exact. All other cases follow by symmetry. □

7E. Semisimplicity. Recall that the elements of, say, an abelian category, are the simples, cf. Section 6J. The simplest compounds are:

Definition 7.25 *An object $\mathbf{X} \in \mathbf{C}$ with $\mathbf{C} \in \text{Cat}_{\oplus \mathbb{E}}$ is called semisimple if*

$$\mathbf{X} \cong \mathbf{L}_1 \oplus \dots \oplus \mathbf{L}_r, \quad \text{where } \mathbf{L}_i \in \text{Si}(\mathbf{C}).$$

Definition 7.26 *A category $\mathbf{C} \in \text{Cat}_{\oplus \mathbb{E}}$ is called semisimple if all of its objects are semisimple.*

Example 7.27 *Again, we already know several (non-)examples:*

- (a) The archetypical example is fdVec_k, since every finite dimensional vector space X is isomorphic to $r \cdot k$ for some $r \in \mathbb{N}$. SS
- (b) Let G be a finite group. Clearly, all categories of the form Vec_{k⊕}^ω(G) are semisimple since all objects are direct sums of simple objects, by definition. SS
- (c) Non-examples are the categories fdMod(A) and fdMod($\overline{\mathbb{F}}_5[\mathbb{Z}/5\mathbb{Z}]$) from [Example 6.67.\(b\)](#) and [Example 6.91](#), respectively. In both cases there is only one simple and its projective cover is not simple, but indecomposable. L → SS Z₂ ≠ ⊕ L₁

Recalling Schur’s lemma [Lemma 6.69](#), the following says that semisimple categories have controllable hom spaces:

Proposition 7.28 *Let \mathbb{K} be algebraically closed, and $\mathbf{C} \in \mathbf{Cat}_{\oplus \in}$ be locally additively finite. Then \mathbf{C} is semisimple if and only if, for any $X, Y \in \mathbf{C}$, we have an isomorphism*

$$(7-8) \quad \bigoplus_{L \in \text{Si}(\mathbf{C})} (\text{Hom}_{\mathbf{C}}(X, L) \times \text{Hom}_{\mathbf{C}}(L, Y)) \xrightarrow{\cong} \text{Hom}_{\mathbf{C}}(X, Y), \quad (f, g) \mapsto gf.$$

Proof. By decomposing X and Y into their simple components, one direction is a direct consequence of [Lemma 6.69](#). To see the converse, note that (7-8) is equivalent to saying that the finite dimensional \mathbb{K} vector spaces $Z = \text{Hom}_{\mathbf{C}}(X, L)$ and $Z^* = \text{Hom}_{\mathbf{C}}(L, X)$ are duals. In particular, if these are non-zero, then the evaluation and coevaluation from [Example 4.11](#) provide the idempotent $\text{coev}^Z \text{ev}_Z \in ZZ^* \cong \text{End}_{\mathbf{C}}(X)$, showing that $L \in X$. Finally, since $\text{End}_{\mathbf{C}}(X)$ is finite, there are only finitely many $L \in \text{Si}(\mathbf{C})$ for which $\text{Hom}_{\mathbf{C}}(X, L)$ and $\text{Hom}_{\mathbf{C}}(L, X)$ are non-zero. \square

Lemma 7.29 *Let $\mathbf{C} \in \mathbf{Cat}_{\oplus \in}$ be locally additively finite.*

- (i) *If \mathbf{C} is semisimple, then $\text{Si}(\mathbf{C}) \subset \text{Pi}(\mathbf{C})$.*
- (ii) *If $\text{Si}(\mathbf{C}) \subset \text{Pi}(\mathbf{C})$, then \mathbf{C} is semisimple.*
- (iii) *If \mathbf{C} is semisimple, then $\text{Si}(\mathbf{C}) \subset \text{Ii}(\mathbf{C})$.*
- (iv) *If $\text{Si}(\mathbf{C}) \subset \text{Ii}(\mathbf{C})$, then \mathbf{C} is semisimple.*

Proof. (i). Using Schur’s lemma [Lemma 6.68](#) and semisimplicity, we can fill in the universal diagram as follows. We can only have an epic morphism $p: L \rightarrow X$ from a simple L to a non-zero X if $L \in X$. Similarly, we can only have an epic morphism $f: Y \rightarrow X$ from a non-zero Y to X if $X \in Y$. In particular, $L \in Y$, and we can define the required $u: L \rightarrow Y$ by the universal property of the direct sum.

(ii). Assume that $X \cong Z_1 \oplus \dots \oplus Z_n$ is a Krull–Schmidt decomposition and that $f: X \rightarrow L$ is a epic morphism to a simple L . Since L is projective we can use its universal property and get

$$\begin{array}{ccc}
 & L & \\
 \exists! \swarrow u & & \downarrow \text{id}_L \\
 X & \dashrightarrow & L
 \end{array}$$

The morphism fu is an idempotent since $fufu = \text{id}_L u$, so $L \in X$. This implies that $L \cong Z_i$ for some i . Now proceed inductively.

(iii)+(iv). From (i) respectively (ii), by symmetry. \square

In particular, we get:

$S_{in} = Proj$

Lemma 7.30 A locally additively finite category $\mathbf{C} \in \mathbf{Cat}_{\oplus \epsilon}$ is semisimple if and only if $S_i(\mathbf{C}) = P_i(\mathbf{C})$ if and only if $S_i(\mathbf{C}) = I_i(\mathbf{C})$. \square

Clearly, we have the *category of semisimple categories* $\mathbf{Cat}_S \subset \mathbf{Cat}_{\oplus \epsilon}$ being the corresponding full subcategory. More surprisingly:

Theorem 7.31 We have $\mathbf{Cat}_S \subset \mathbf{Cat}_{lA}$.

$SS \Rightarrow$ fiat
tensor

In words, semisimple implies locally finite abelian.

Proof. For $\mathbf{C} \in \mathbf{Cat}_S$ take $P = \bigoplus_{L \in S_i(\mathbf{C})} L$, which is a projective object by Lemma 7.30. We consider

$$A = \text{End}_{\mathbf{C}}(P).$$

Then we get an exact equivalence

$$\text{Hom}_{\mathbf{C}}(P, -): \mathbf{C} \xrightarrow{\simeq_e} \mathbf{Mod}(A).$$

Thus, \mathbf{C} is abelian. That it is also locally finite is a direct consequence of the definition of semisimplicity and Schur's lemma Lemma 6.69, since each object of \mathbf{C} is a finite direct sum of simples. \square

Example 7.32 Example 7.27 and Theorem 7.31 immediately imply that $\mathbf{Vec}_{\mathbb{k} \oplus}^{\omega}(G)$ are all abelian (for G being a finite group).

Definition 7.33 An algebra $A \in \mathbf{fdVec}_{\mathbb{k}}$ is called semisimple if $\mathbf{fdMod}(A)$ is semisimple.

Example 7.34 The classical Artin–Wedderburn theorem, see e.g. [Be91, Theorem 1.3], says that a \mathbb{k} algebra $A \in \mathbf{fdVec}_{\mathbb{k}}$ is semisimple if and only if $\mathbf{fdMod}(A) \cong \bigoplus_{i=1}^r \mathbf{fdVec}_{\mathbb{k}}$. Thus, the prototypical examples of semisimple algebras are \mathbb{k} and direct sums of it.

Proposition 7.35 A category $\mathbf{C} \in \mathbf{Cat}_{\mathbb{k}fA}$ is semisimple if and only if $\mathbf{C} \simeq_e \bigoplus_{i=1}^r \mathbf{fdVec}_{\mathbb{k}}$ for some $r \in \mathbb{N}$.

Proof. That $\bigoplus_{i=1}^r \mathbf{fdVec}_{\mathbb{k}}$ is semisimple is clear. The converse follows from Theorem 6.44.(ii) and Example 7.34. \square

In words, Proposition 7.35 says that semisimple categories are categorically boring. However, this is not taking e.g. the monoidal structure into account. (The analogy on the Grothendieck classes is that whenever one has a ring, one should not forget the multiplication.) Thus, let us come back to fiat and tensor categories. The following is the categorical version of Maschke's theorem:

Theorem 7.36 Let $\mathbf{C} \in \mathbf{wmlFiat}$ or $\mathbf{C} \in \mathbf{wmlTen}$. Then \mathbf{C} is semisimple if and only if $\mathbb{1} \in \mathbf{Proj}(\mathbf{C})$ if and only if $\mathbb{1} \in \mathbf{Inj}(\mathbf{C})$.

Proof. By combining Proposition 7.24 and Lemma 7.30. \square

Example 7.37 The classical formulation of Maschke's theorem is the following: "Let G be a finite group of order $m = \#G$ and \mathbb{K} be algebraically closed. Then $\mathbf{fdMod}(G)$ is semisimple if and only if $\text{char}(\mathbb{K}) \nmid m$. The original proof of Maschke uses [Theorem 7.36](#) in the following incarnation: First, observe that $\mathbb{K}[G] \in \mathbf{fdMod}(G)$ is projective, and so are its direct summands. Further, the sum of all group elements

$$x = \sum_{i=1}^m g_i \in \mathbb{K}[G] \cong \text{End}_{\mathbf{fdMod}(G)}(\mathbb{K}[G]), \quad G = \{g_1, \dots, g_m\},$$

spans a copy of the trivial G module $\mathbb{1}$, which is the monoidal unit in $\mathbf{fdMod}(G)$. Now the crucial calculation:

$$x^2 = m \cdot x.$$

m = |G|

Thus, if $m \neq 0$ in \mathbb{K} , then we get an idempotent $\frac{1}{m} \cdot x$ showing that $\mathbb{1} \in \mathbb{K}[G]$. Hence, $\mathbb{1}$ is projective.

Lemma 7.38 For any \mathbb{k} linear $\mathbf{C} \in \mathbf{wmfTen}$ the \mathbb{k} algebra $\text{End}_{\mathbf{C}}(\mathbb{1})$ is semisimple.

Proof. We already know that $\text{End}_{\mathbf{C}}(\mathbb{1})$ is a commutative \mathbb{k} algebra, cf. [Proposition 2.36](#), which is also finite dimensional. By Artin–Wedderburn, it thus remains to show that $f^2 = 0$ implies $f = 0$ for all $f \in \text{End}_{\mathbf{C}}(\mathbb{1})$. So assume that we have such a morphism. We observe that

$$\text{Im}(f)\text{Im}(f) \cong \text{Im}(f^2) \cong \text{Im}(0) \cong 0, \quad \text{Im}(f)\text{Ker}(f) \cong \text{Ker}(f)\text{Im}(f) \cong 0.$$

Thus, \otimes multiplying

$$\text{Ker}(f) \xleftarrow{i} \mathbb{1} \xrightarrow{p} \text{Im}(f) \text{ SES}$$

with $\text{Im}(f)$ shows, by [Proposition 7.23](#), that $\text{Im}(f) \cong 0$ and we are done. □

7F. A bit more diagrammatics. Let us revised the categories \mathbf{TL} , see [Example 3.23](#), and \mathbf{Br} , see [Example 3.24](#).

Definition 7.39 Let $q^{1/2} \in \mathbb{S}^*$. The Rumer–Teller–Weyl category $\mathbf{TL}_{\mathbb{S} \oplus \mathbb{E}}^q$ is the quotient of $\mathbf{TL}_{\mathbb{S} \oplus \mathbb{E}}$ by the circle removal

(7-9) $\bigcirc = -(q + q^{-1}).$

We further endow $\mathbf{TL}_{\mathbb{S} \oplus \mathbb{E}}^q$ with the structure of a braided category by

(7-10) $\begin{matrix} \diagdown & \diagup \\ \diagup & \diagdown \end{matrix} = q^{1/2} \cdot \begin{matrix} | & | \\ | & | \end{matrix} + q^{-1/2} \cdot \begin{matrix} \diagup & \diagdown \\ \diagdown & \diagup \end{matrix}, \quad \begin{matrix} \diagdown & \diagup \\ \diagdown & \diagup \end{matrix} = q^{-1/2} \cdot \begin{matrix} | & | \\ | & | \end{matrix} + q^{1/2} \cdot \begin{matrix} \diagup & \diagdown \\ \diagup & \diagdown \end{matrix}.$

Clearly, (7-10) implies the so-called Kauffman skein relation

(7-11) $\begin{matrix} \diagdown & \diagup \\ \diagdown & \diagup \end{matrix} - \begin{matrix} \diagdown & \diagup \\ \diagup & \diagdown \end{matrix} = (q^{1/2} - q^{-1/2}) \left(\begin{matrix} | & | \\ | & | \end{matrix} - \begin{matrix} \diagdown & \diagup \\ \diagdown & \diagup \end{matrix} \right).$

Lemma 7.40 The category $\mathbf{TL}_{\mathbb{S} \oplus \mathbb{E}}^q$ is braided with the braiding in (7-10) fiat category.

Proof. First note that (7-9) and isotopy invariance shows that the hom spaces of $\mathbf{TL}_{\mathbb{S} \oplus \mathbb{E}}^q$ are finite dimensional. To see this we first observe that diagram bending [Theorem 4.16](#) shows that it is

enough to verify that endomorphism spaces are finite dimensional. For endomorphism spaces we have the defining relations

$$u_i = \bigcap_i, \quad u_i^2 = -(q + q^{-1})u_i, \quad u_i u_j u_i = u_i \text{ if } |i - j| = 1, \quad u_i u_j = u_j u_i \text{ if } |i - j| > 1,$$

which we wrote in algebraic notation, where the subscript indicates the position, reading left-to-right, of the left strand. The above implies that

$$\text{End}_{\mathbf{TL}_{\mathbb{S} \oplus \mathbb{E}}^q}(\mathbb{1}) \cong \mathbb{S},$$

(this follows because the Skein relations imply that every link can be reduced to a linear combination of circles) showing that we can drop the “multi”. The claim that (7-10) is a braiding is Exercise 7.61. \square

A calculation shows that

$$\bigcap = -q^{-3/2} \bigcup,$$

$$\bigcap = -\frac{3/2}{q} \bigcup$$

holds in $\mathbf{TL}_{\mathbb{S} \oplus \mathbb{E}}^q$, and thus, $\mathbf{TL}_{\mathbb{S} \oplus \mathbb{E}}^q$ satisfies (5-18). Hence, we get our first quantum invariant, which is ribbon:

Proposition 7.41 *There exists a well-defined functor*

$$\mathbf{RT}_{r=2}^A : \mathbf{1rTan} \rightarrow \mathbf{TL}_{\mathbb{S} \oplus \mathbb{E}}^q, \quad \bullet \mapsto \bullet, \quad \bigcap \mapsto \bigcap, \quad \bigcup \mapsto \bigcup, \quad \cup \mapsto \cup,$$

of braided pivotal categories. *links*

Proof. By construction, there is almost nothing to show: $\mathbf{1rTan}$ is the free braided pivotal category generated by one self-dual object, and thus there exists the claimed functor by Lemma 7.40. \square

Example 7.42 *The value $\mathbf{RT}_{r=2}^A(l)$ of a link l , which, by definition, is a morphism $l \in \text{End}_{\mathbf{1rTan}}(\mathbb{1})$, is an element of \mathbb{S} , and an invariant of the link. To be completely explicit, take $\mathbb{S} = \mathbb{Z}[q^{1/2}, q^{-1/2}]$ and q being the corresponding formal variable. Then $\mathbf{RT}_{r=2}^A(l)$ is a (Laurent) polynomial, which is (up to normalization) the so-called Jones polynomial. For instance, take l to be the Hopf link:*

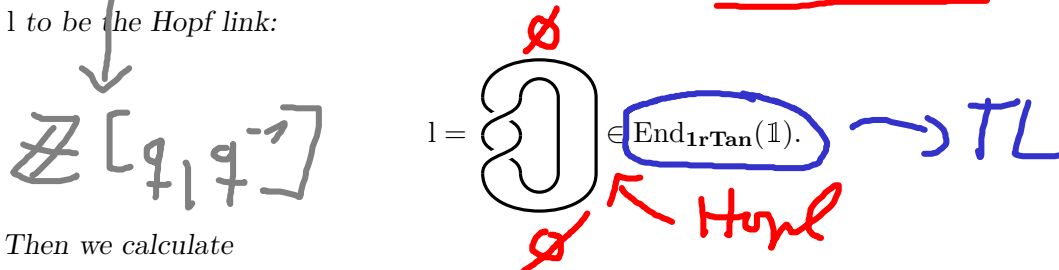

Then we calculate

$$\begin{aligned} \mathbf{RT}_{r=2}^A(l) &= \text{[Diagram of Hopf link with green and blue strands]} \\ &= q \cdot \text{[Diagram 1]} + \text{[Diagram 2]} + \text{[Diagram 3]} + q^{-1} \cdot \text{[Diagram 4]} \\ &= q(q + q^{-1})^2 - 2(q + q^{-1}) + q^{-1}(q + q^{-1})^2 = q^3 + q + q^{-1} + q^{-3}, \end{aligned}$$

which, up to normalization, is the Jones polynomial of the Hopf link.

Similarly:

Definition 7.43 Let $q, a \in \mathbb{S}^*$, with $q \neq q^{-1}$. The quantum Brauer category $\mathbf{rqBr}_{\mathbb{S} \oplus \mathbb{E}}^{a,q}$ is the quotient of $\mathbf{qBr}_{\mathbb{S} \oplus \mathbb{E}}$ by the circle removal

$$(7-12) \quad \bigcirc = \left(\frac{a-a^{-1}}{q-q^{-1}} + 1 \right),$$

and the Kauffman skein and twist relations

$$(7-13) \quad \begin{array}{c} \diagdown \diagup - \diagup \diagdown = (q - q^{-1}) (\big| \big| - \diagdown \diagup) \\ \bigcirc = a^{-1} \cdot \curvearrowright, \quad \bigcirc = a \cdot \curvearrowleft \end{array}$$

The following can be proven analogously as Lemma 7.40 and omitted for the time being.

Lemma 7.44 The category $\mathbf{rqBr}_{\mathbb{S} \oplus \mathbb{E}}^q$ is a braided (with the braiding in (7-13)) l fiat category. \square

Note that we have

$$\big| \rho = a \cdot \big| \leftarrow \begin{array}{c} \cup \\ \text{apply to the left} \end{array} \bigcirc = a \cdot \curvearrowright \begin{array}{c} \cup \\ \text{apply to the right} \end{array} \big| \rho = a \cdot \big| \big|$$

This implies that $\mathbf{rqBr}_{\mathbb{S} \oplus \mathbb{E}}^q$ is indeed ribbon since it satisfies (5-18). Hence, we get another quantum invariant, the proof being the same as before:

Proposition 7.45 There exists a well-defined functor

$$\mathbf{RT}_{\infty}^{BCD} : \mathbf{1rTan} \rightarrow \mathbf{rqBr}_{\mathbb{S} \oplus \mathbb{E}}^{a,q}, \quad \bullet \mapsto \bullet, \quad \diagdown \diagup \mapsto \diagdown \diagup, \quad \curvearrowright \mapsto \curvearrowright, \quad \cup \mapsto \cup,$$

of braided pivotal categories. \square

Example 7.46 For the Hopf link as in Example 7.42 we get

$$\begin{aligned} \mathbf{RT}_{r=\infty}^{BCD}(1) &= \text{Hopf link} = \text{Hopf link} + (q - q^{-1}) (\text{Hopf link} - \text{Hopf link}) \\ &= \left(\frac{a-a^{-1}}{q-q^{-1}} + 1 \right)^2 + (q - q^{-1})(a - a^{-1}) \left(\frac{a-a^{-1}}{q-q^{-1}} + 1 \right) \\ &\stackrel{a=q^2}{=} (q + q^{-1})(q^3 + 1 + q^{-3}), \end{aligned}$$

where we substituted $a = q^2$ in the last equation to get a nice and short formula.

Remark 7.47 Actually, adding orientations would give quantum invariants of **1Ribbon**. Moreover, one can normalize the two invariants above and similar invariants to get a quantum invariant of **1State**, i.e. with honest Reidemeister 1 moves (5-17).

7G. Multiplicative structures on Grothendieck classes. Let us come back to Definition 6.86.

Definition 7.48 Let $\mathbf{C} \in \mathbf{Fiat}$ and $\mathbf{D} \in \mathbf{Ten}$. Then we define the additive Grothendieck classes $K_0^\oplus(\mathbf{C})$ of \mathbf{C} respectively the SES Grothendieck classes $K_0^e(\mathbf{D})$ of \mathbf{D} verbatim as in [Definition 6.86](#).

Clearly, we have the analogs of [Proposition 4.27](#) and [Lemma 6.87](#):

Proposition 7.49 Let $\mathbf{C} \in \mathbf{Fiat}$ and $\mathbf{D} \in \mathbf{Ten}$. Then:

(i) [Definition 7.48](#) endows $K_0^\oplus(\mathbf{C})$ and $K_0^e(\mathbf{D})$ with the structures of finite dimensional abelian groups.

(ii) The set $\text{In}(\mathbf{C})$ is a basis of $K_0^\oplus(\mathbf{C})$. We have

$$[\mathbf{X}] = \sum_{i=1}^n (\mathbf{X} : \mathbf{Z}_i) \cdot [\mathbf{Z}_i] \in K_0^\oplus(\mathbf{C}).$$

(iii) The set $\text{Si}(\mathbf{D})$ is a basis of $K_0^e(\mathbf{D})$. We have

$$[\mathbf{X}] = \sum_{i=1}^n [\mathbf{X} : \mathbf{L}_i] \cdot [\mathbf{L}_i] \in K_0^e(\mathbf{D}).$$

(iv) For both, $K_0^\oplus(\mathbf{C})$ and $K_0^e(\mathbf{D})$, the additional structures in [Proposition 4.27](#) are compatible with the \mathbb{S} linear and additive structures. In particular, $K_0^\oplus(\mathbf{C})$ and $K_0^e(\mathbf{D})$ are finite dimensional \mathbb{Z} algebras. \square

By [Lemma 2.28](#) and [Lemma 6.88](#) we also have:

Proposition 7.50 Let $\mathbf{C}, \mathbf{C}' \in \mathbf{Fiat}$, and let $\mathbf{D}, \mathbf{D}' \in \mathbf{Ten}$.

(i) Any functor $\mathbf{F} \in \mathbf{Hom}_{\mathbf{k} \oplus \star}(\mathbf{C}, \mathbf{C}')$ induces a \mathbb{Z} algebra homomorphism

$$K_0^\oplus(\mathbf{F}): K_0^\oplus(\mathbf{C}) \rightarrow K_0^\oplus(\mathbf{C}'), [\mathbf{X}] \mapsto [\mathbf{F}(\mathbf{X})].$$

Further, if \mathbf{F} is an equivalence, then $K_0^\oplus(\mathbf{F})$ is an isomorphism.

(ii) Any functor $\mathbf{F} \in \mathbf{Hom}_{\mathbf{k}e\star}(\mathbf{D}, \mathbf{D}')$ induces a \mathbb{Z} algebra homomorphism

$$K_0^e(\mathbf{F}): K_0^e(\mathbf{D}) \rightarrow K_0^e(\mathbf{D}'), [\mathbf{X}] \mapsto [\mathbf{F}(\mathbf{X})].$$

Further, if \mathbf{F} is an equivalence, then $K_0^e(\mathbf{F})$ is an isomorphism. \square

This gives a (coarse) numerical invariant:

Proposition 7.51 Let $\mathbf{C} \in \mathbf{Fiat}$, and let $\mathbf{D} \in \mathbf{Ten}$. The the ranks $\text{rk}(\mathbf{C})$ and $\text{rk}(\mathbf{D})$, i.e. the dimensions of $K_0^\oplus(\mathbf{C})$ and $K_0^e(\mathbf{D})$, respectively, are invariants of \mathbf{C} respectively \mathbf{D} \square

Remark 7.52 All of the above finiteness condition prevent that we run into the **Eilenberg swindle**: If $\mathbf{X} \cong \mathbf{Y} \oplus \mathbf{Y} \oplus \mathbf{Y} \oplus \mathbf{Y} \oplus \dots$ would be an allowed object, then $\mathbf{X} \oplus \mathbf{Y} \cong \mathbf{X}$ which gives $[\mathbf{Y}] = 0$. This would then hold for any object, as \mathbf{Y} was arbitrary.

Example 7.53 In [Example 7.20](#), we have isomorphisms of rings

$$[\mathbf{P}_1] \mapsto 5 \rightsquigarrow K_0^\oplus(\mathbf{C}') \xrightarrow{\cong} 5\mathbb{Z} \subset \mathbb{Z} \xleftarrow{\cong} K_0^e(\mathbf{C}) \leftarrow 1 \leftarrow [\mathbf{L}_1].$$

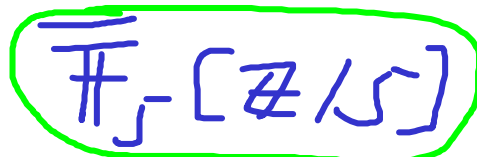

$\overline{\mathbb{F}}_5[\mathbb{Z}/5\mathbb{Z}]$

Further, the endofunctor $- \otimes P_1 : \mathbf{C} \rightarrow \mathbf{C}$ gives

$$[- \otimes P_1] : \mathbb{Z} \rightarrow \mathbb{Z}, \quad 1 \mapsto 5.$$

Moreover, $Z_1 = \mathbb{1}$ is the monoidal unit of \mathbf{C} , $P_1 = Z_5$ a “big pseudo idempotent” and

(7-14)

\otimes	Z_1	Z_2	Z_3	Z_4	Z_5
Z_1	Z_1	Z_2	Z_3	Z_4	Z_5
Z_2	Z_2	$Z_1 \oplus Z_3$	$Z_2 \oplus Z_4$	$Z_3 \oplus Z_5$	$2 \cdot Z_5$
Z_3	Z_3	$Z_2 \oplus Z_4$	$Z_1 \oplus Z_3 \oplus Z_5$	$Z_2 \oplus Z_5 \oplus Z_5$	$3 \cdot Z_5$
Z_4	Z_4	$Z_3 \oplus Z_5$	$Z_2 \oplus Z_5 \oplus Z_5$	$Z_1 \oplus Z_5 \oplus Z_5 \oplus Z_5$	$4 \cdot Z_5$
Z_5	Z_5	$2 \cdot Z_5$	$3 \cdot Z_5$	$4 \cdot Z_5$	$5 \cdot Z_5$

$K_0(\mathbf{C})$

(One can check this using the Jordan decomposition over $\overline{\mathbb{F}}_5$.) Thus, we have an isomorphism of rings

$$K_0^\oplus(\mathbf{C}) \cong \mathbb{Z}, \quad [Z_i] \mapsto i.$$

Finally, note that (7-14) also shows clearly the pivotal structure, since $Z_1 = \mathbb{1} \in Z_i Z_j$ if and only if $i = j$ and $i < 5$. This shows that all indecomposables are self-dual (since Z_5 is the projective cover of Z_1 , the monoidal product $Z_5 Z_5$ has a map to Z_1 regardless whether Z_1 appears as a summand of it).

Remark 7.54 All of the above have appropriate versions in the “weakly” and “multi” setup.

7H. **Finite dimensional algebras in vector spaces.** Here is the main source of examples of tensor categories:

Theorem 7.55 Let $A \in \mathbf{fdVec}_\mathbb{k}$ be a Hopf algebra. Then $\mathbf{fdMod}(A) \in \mathbf{mTen}$.

Proof. Combining Theorem 6.44.(ii), showing that $\mathbf{fdMod}(A)$ is finite abelian, and Theorem 5.58, showing that $\mathbf{fdMod}(A)$ is rigid, and observing that everything is compatible with the \mathbb{k} linear structure. □

So Hopf algebras play a crucial role in the construction of quantum invariants. As an aside, another nice fact about Hopf algebras is that they are “group-like”. Let us make this precise. To this end, let \mathbf{SAlg} denote the category of \mathbb{S} algebras, objects being \mathbb{S} algebras and morphisms \mathbb{S} algebra homomorphisms. Further, let $\mathbf{Gr} \subset \mathbf{Mon}$ (recall \mathbf{Mon} being the category of monoids, cf. Example 1.6.(a)) denote the full subcategory whose objects are groups, i.e. the category of groups.

Definition 7.56 We call $F \in \mathbf{Hom}(\mathbf{SAlg}, \mathbf{Gr})$ representable if $\mathbf{Forget} \circ F \in \mathbf{Hom}(\mathbf{SAlg}, \mathbf{Set})$ is representable in the sense of Example 1.37.

Proposition 7.57 Let $F \in \mathbf{Hom}(\mathbf{SAlg}, \mathbf{Gr})$ be represented by $A \in \mathbf{SAlg}$. Then:

- (i) For all $A \in \mathbf{SAlg}$, the set $\mathbf{Hom}_{\mathbf{SAlg}}(A, A)$ has a group structure.
- (ii) The multiplication and unit in (i) come from a comultiplication and an antipode on A , making A into a Hopf algebra.

For this reason one can say that Hopf algebras are *cogroup objects in SAlg*.

Proof. This is [Exercise 7.62](#). □

7I. Exercises.

Exercise 7.58 Prove the missing points in [Proposition 7.7](#).

Exercise 7.59 Try to make [Remark 7.17](#) precise by drawing a hierarchy chart and by giving examples whenever *Notion A* $\not\approx$ *Notion B*.

Exercise 7.60 Understand [Example 7.20](#) and make all claims made in that example precise, e.g. the monoidal structure.

Exercise 7.61 Show that (7-10) defines the structure of a braided category on $\mathbf{TL}_{\mathbb{S} \oplus \mathbb{E}}^q$. Compute the quantum invariant $RT_{r=2}^A(-)$ for

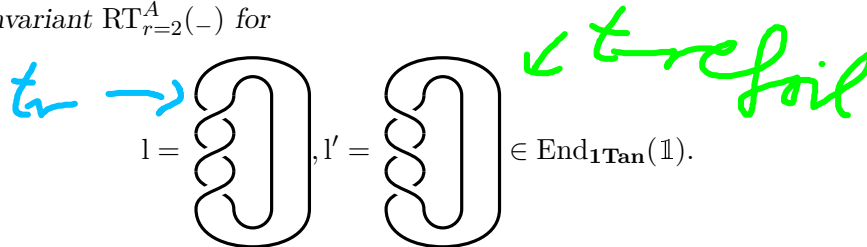

This is the trefoil knot and its mirror image. Deduce that they are not equivalent.

Exercise 7.62 Prove [Proposition 7.57](#). Hint: Yoneda.

8. FIAT, TENSOR AND FUSION CATEGORIES – DEFINITIONS AND CLASSIFICATIONS

Fiat and tensor categories categorify algebras, and, in some sense, as we will see, when they are semisimple they categorify finite groups. A first thing one would try when studying finite groups is to classify them, maybe after fixing some numerical invariant such as the size of the group. (A statement of the form “All finite groups of prime order are cyclic.” comes to mind.) So:

Can one hope to classify (semisimple) fiat and tensor categories, maybe after fixing some numerical invariant?

The answer will turn out to be “Yes and no.”

8A. A word about conventions. Of course, we keep the previous conventions.

Convention 8.1 We will identify directed graphs Γ and their adjacency matrices M , which we see as matrices with values in \mathbb{N} , and we will write Γ for both if no confusion can arise. The translation between these two notions is best illustrated in an example:

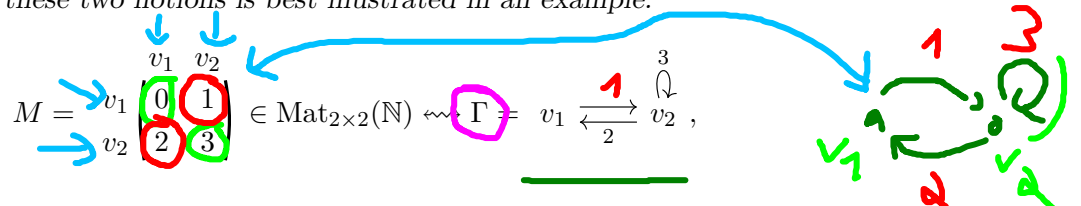

where labels mean parallel edges, with the label 1 being omitted from illustrations.



Convention 8.2 Out notation convention for objects is:

$X \leftrightarrow$ general object, $L \leftrightarrow$ simple object, $P \leftrightarrow$ projective inde. object,
 $I \leftrightarrow$ injective inde. object, $Z \leftrightarrow$ indecomposable object,

(We also tend to use projectives instead of the dual notion of injectives.) Recall also that for semisimple categories

X is simple $\Leftrightarrow X$ is projective inde. $\Leftrightarrow X$ is injective inde. $\Leftrightarrow X$ is indecomposable.

Although we are mostly concerned about indecomposables, we will use the notation L in the semisimple case to stress that this case is easier than the general situation.

8B. Representations of groups and Hopf algebras. We start by discussing a very nicely behaved case in details: Let G be a finite group of order $\#G = m$, and let p be the characteristic of the algebraically closed ground field \mathbb{K} . Recall that $k[G] = (\mathbb{K}[G], \text{m.i.d.e.s})$ is a Hopf algebra in $\text{Vec}_{\mathbb{K}}$. The explicit structure maps are the multiplication and unit in $\mathbb{K}[G]$, and

$$d(g) = g \otimes g, \quad e(g) = 1, \quad s(g) = g^{-1}.$$

Thus, $\text{fdMod}(\mathbb{K}[G])$ is \mathbb{K} linear abelian rigid (actually, it is even pivotal). Moreover, by (6-16) we have

$$(8-1) \quad \sum_{i=1}^n \dim(L_i)^2 \leq \sum_{i=1}^n \dim(L_i)\dim(P_i) = \dim(k[G]) = m.$$

We also know by Lemma 7.29 that equality holds in (8-1) if and only if $\text{fdMod}(\mathbb{K}[G])$ is semisimple. The latter, by Maschke's theorem Example 7.37, happens if and only if $p \nmid m$.

Remark 8.3 In fact, (8-1) holds for any finite dimensional k algebra A , i.e.

$$\sum_{i=1}^n \dim(L_i)^2 \leq \sum_{i=1}^n \dim(L_i)\dim(P_i) = \dim(A),$$

with equality if and only if A is semisimple.

Example 8.4 Let us perform the calculation

$$(X - 1)^5 = X^5 - 5X^4 + 10X^3 - 10X^2 + 5X - 1 \stackrel{p=5}{=} X^5 - 1,$$

which is called **Freshman's dream**. Hence, in characteristic 5 there is only the trivial 5th root of unity $\zeta = 1$. In all other cases there are five primitive roots of unity $\{1 = \zeta^0, \zeta^1, \zeta^2, \zeta^3, \zeta^4\}$, e.g. for $\mathbb{K} = \mathbb{C}$ we could let $\zeta = \exp(2\pi i/5)$. (See also (6-17) and the text below.) Let us now come back to $G = \mathbb{Z}/5\mathbb{Z}$, see also Example 6.91, where

$$\begin{pmatrix} \zeta^0 & 0 & 0 & 0 & 0 \\ 0 & \zeta^1 & 0 & 0 & 0 \\ 0 & 0 & \zeta^2 & 0 & 0 \\ 0 & 0 & 0 & \zeta^3 & 0 \\ 0 & 0 & 0 & 0 & \zeta^4 \end{pmatrix} \xrightarrow{p \neq 5} \begin{pmatrix} 0 & 0 & 0 & 0 & 1 \\ 1 & 0 & 0 & 0 & 0 \\ 0 & 1 & 0 & 0 & 0 \\ 0 & 0 & 1 & 0 & 0 \\ 0 & 0 & 0 & 1 & 0 \end{pmatrix} \xrightarrow{p=5} \begin{pmatrix} 1 & 0 & 0 & 0 & 0 \\ 1 & 1 & 0 & 0 & 0 \\ 0 & 1 & 1 & 0 & 0 \\ 0 & 0 & 1 & 1 & 0 \\ 0 & 0 & 0 & 1 & 1 \end{pmatrix}$$

is the matrix for the multiplication action of 1 on $\mathbb{K}[\mathbb{Z}/5\mathbb{Z}]$, which has the characteristic polynomial $X^5 - 1$. We also gave the corresponding Jordan decompositions. Thus, we get two different cases:

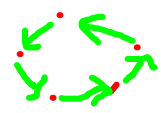

$1 \in \mathbb{Z}/5\mathbb{Z}$

- If \mathbb{K} is not of characteristic 5, then

$\mathbb{K} \rightarrow L_1 = \mathbb{1}: \begin{pmatrix} \zeta^0 \end{pmatrix}, L_2: \begin{pmatrix} \zeta^1 \end{pmatrix}, L_3: \begin{pmatrix} \zeta^2 \end{pmatrix}, L_4: \begin{pmatrix} \zeta^3 \end{pmatrix}, L_5: \begin{pmatrix} \zeta^4 \end{pmatrix},$

defines five simples, all of dimension 1. (They, of course, correspond to the five elements of $\mathbb{Z}/5\mathbb{Z}$, as indicated by ζ^i .) They are also projective, the idempotents splitting them from $\mathbb{K}[\mathbb{Z}/5\mathbb{Z}]$ can be obtained by using the change-of-basis matrices from the action matrix to its Jordan decomposition. Hence, formula (8-1) takes the form

$1^2 + 1^2 + 1^2 + 1^2 + 1^2 = 5. = \dim \mathbb{Z}/5\mathbb{Z} = 5$

- We have already seen the case where \mathbb{K} is of characteristic 5, say $\mathbb{K} = \overline{\mathbb{F}}_5$, in detail, see e.g. Example 6.91. In this case we have one simple $L_1 = \mathbb{1}$ and its projective cover $P_1 \cong \overline{\mathbb{F}}_5[\mathbb{Z}/5\mathbb{Z}]$. Thus, (8-1) takes the form

$1 = 1^2 \leq 1 \cdot 5 = 5.$

abelian

⊕

Note that (8-1) implies that the set of simples $\text{Si}(\mathbf{fdMod}(\mathbb{K}[G]))$ (or of projectives indecomposables or of injectives indecomposables) of $\mathbf{fdMod}(\mathbb{K}[G])$ is always finite. What about the additive version, i.e. what about the set of indecomposables $\text{In}(\mathbf{fdMod}(\mathbb{K}[G]))$? We have already seen in the case $G = \mathbb{Z}/5\mathbb{Z}$ that $\#\text{Si}(\mathbf{fdMod}(\mathbb{K}[G])) \leq \#\text{In}(\mathbf{fdMod}(\mathbb{K}[G]))$ with equality if and only if we are in the semisimple situation. Actually, the difference can get arbitrary big:

Example 8.5 Klein's group of order four is $V_4 = \mathbb{Z}/2\mathbb{Z} \times \mathbb{Z}/2\mathbb{Z} = \langle s, t \mid s^2 = t^2 = 1, st = ts \rangle$, with its defining action on the complex plane $\mathbb{C}^2 = \{a + ib \mid a, b \in \mathbb{R}\}$ given by reflections:

$4 \cdot 1^2 = 4$

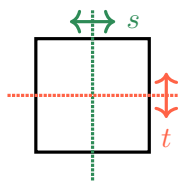

$s \cdot (a + ib) = -a + ib,$
 $t \cdot (a + ib) = a - ib.$

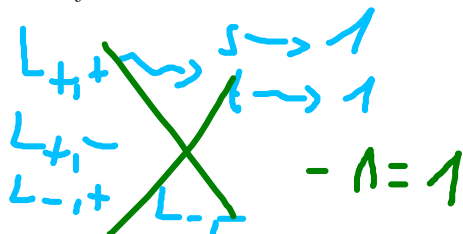

For \mathbb{K} not of characteristic 2 the category $\mathbf{fdMod}(\mathbb{K}[V_4])$ is semisimple with four simples of dimension one. The case $\mathbb{K} = \overline{\mathbb{F}}_2$ is very different, and we will discuss it now. In this case we have

$\overline{\mathbb{F}}_2[V_4] \xrightarrow{\cong} A = \overline{\mathbb{F}}_2[X, Y]/(X^2, Y^2),$ $s \mapsto X + 1, t \mapsto Y + 1,$

by Freshman's dream.

Let us first discuss the simples and projectives of A. It is easy to see that A has one simple L_1 whose projective cover P_1 is A itself:

(8-2) $1^2 \leq 4$

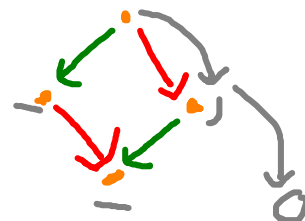
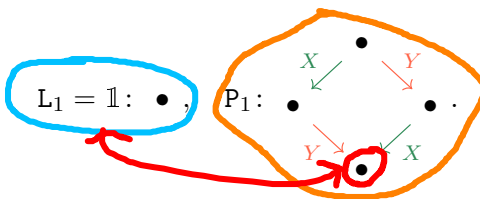

Here we use a graph to indicate the modules. This is to be read as follows: the vertices correspond to basis elements while the arrows indicate the non-zero actions of X and Y.

In contrast, there are infinitely many indecomposables, which are not projective. Here is the list of all of them, using the same notation as in (8-2):

- For all $2l + 3$, where $l \in \mathbb{N}$ (thus, $2 \cdot 0 + 3 = 3$ is the smallest case), there are two indecomposables Z_{2l+1} and Z_{2l+1}^* , which are duals:

X

$$Z_{2l+1}: \bullet \xleftarrow{X} \bullet \xrightarrow{Y} \bullet \xleftarrow{X} \bullet \xrightarrow{Y} \bullet \xleftarrow{X} \dots \xrightarrow{Y} \bullet ,$$

$$Z_{2l+1}^*: \bullet \xrightarrow{Y} \bullet \xleftarrow{X} \bullet \xrightarrow{Y} \bullet \xleftarrow{X} \bullet \xrightarrow{Y} \dots \xleftarrow{X} \bullet .$$

Here and below, the subscript indicates the dimension, i.e. the number of vertices.

- X |**
- For all $2l + 2$, where $l \in \mathbb{N}$, there is a self-dual indecomposable Z_{2l} :

$$Z_{2l}: \bullet \xleftarrow{X} \bullet \xrightarrow{Y} \bullet \xleftarrow{X} \bullet \xrightarrow{Y} \bullet \xleftarrow{X} \dots \xrightarrow{Y} \bullet \xleftarrow{X} \bullet .$$

- For $j, l \in \mathbb{N}$ with $j|l$, and an irreducible polynomial $f \in \mathbb{F}_2[Z]$ of degree l/j , let $\Theta_{f,j,l} = \sum_{i=0}^n \Theta_i Z^i = f(Z)^j$ with $\Theta_n = 1$. For all $2l + 2$, where $l \in \mathbb{N}$, and any $\Theta = \Theta_{f,j,l}$ there is another self-dual indecomposable Z_{2l}^Θ :

X

$$Z_{2l}^\Theta: \begin{matrix} \bullet & \xleftarrow{X} & \bullet & \xrightarrow{Y} & \bullet & \xleftarrow{X} & \bullet & \xrightarrow{Y} & \bullet & \xleftarrow{X} & \dots & \xrightarrow{Y} & \bullet & \xleftarrow{X} & \bullet & \xrightarrow{Y} & \bullet \\ 0 & & l+1 & & 1 & & l+2 & & 2 & & \dots & & l & & 2l+1 & & \Theta \end{matrix} ,$$

where at one end, as indicated, Y acts by $Y(2l + 1) = \sum_{i=0}^n \Theta_i i$.

(An explicit example of this family of modules is the case $f(Z) = 1 + Z + Z^2$, $j = 1$ and $l = 3$. Then Z_6^Θ is six dimensional, of the form

$$Z_6^\Theta: \begin{matrix} \bullet & \xleftarrow{X} & \bullet & \xrightarrow{Y} & \bullet & \xleftarrow{X} & \bullet & \xrightarrow{Y} & \bullet & \xleftarrow{X} & \bullet & \xrightarrow{Y} & \bullet \\ 0 & & 3 & & 1 & & 4 & & 2 & & 5 & & \Theta \end{matrix} ,$$

and Y acts on the vertex 5 as $Y(5) = 1 \cdot 0 + 1 \cdot 1 + 1 \cdot 2$.)

The above discussion summarized is:

Proposition 8.6 Let G be a finite group of order $\#G = m$, and let p be the characteristic of the algebraically closed ground field \mathbb{K} . Then:

- (i) We have $\text{fdMod}(\mathbb{K}[G]) \in \text{Cat}_S$ if and only if $p \nmid m$.
- (ii) We have $\text{fdMod}(\mathbb{K}[G]) \in \text{Ten}$.
- (iii) We have $\text{fdMod}(\mathbb{K}[G]) \in \text{Fiat}$ if and only if $p \nmid m$ or the p Sylow subgroup of G is cyclic.

$$\sum \dim L_j^2 \leq m$$

Proof. The only things we have not addressed above are: First, whether $\text{End}_{\text{fdMod}(\mathbb{K}[G])}(\mathbb{1}) \cong \mathbb{K}$. However, since $\mathbb{1}$ is the trivial module, Schur's lemma Lemma 6.69 provides the result. And second, the if and only if condition in (iii) which follow from a classical result giving an if and only if condition for whether $\#\text{In}(\mathbb{K}[G]) < \infty$, see [Hi53]. \square

Remark 8.7 The proof in [Hi53] is effective: Let H be a p -Sylow subgroup of G . Then Higman shows that every indecomposable $\mathbb{K}[G]$ module Z can be obtained as a direct summands $Z \in \mathbb{K}[G] \otimes_{\mathbb{K}[H]} Z'$ for some indecomposable $\mathbb{K}[H]$ module Z' . Because the dimension of $\mathbb{K}[G] \otimes_{\mathbb{K}[H]} Z'$ is $|G/H| \dim(Z')$ there can thus only be finitely many indecomposables if $\mathbb{K}[H]$ has only finitely many indecomposables.

Example 8.8 The two cases of G being either $\mathbb{Z}/4\mathbb{Z}$ or Klein's four group V_4 in characteristic 2 are fundamentally different: For $\mathbb{Z}/4\mathbb{Z}$ the 2-Sylow subgroup is cyclic and the representation

cyclic $\rightarrow \mathbb{Z}/4\mathbb{Z}$ vs. $V_4 = \mathbb{Z}/2 \times \mathbb{Z}/2$ $p=2$ not cyclic

theory of $\overline{\mathbb{F}}_2[\mathbb{Z}/4\mathbb{Z}]$ can be treated verbatim as for $\overline{\mathbb{F}}_5[\mathbb{Z}/5\mathbb{Z}]$, see [Example 6.91](#). For V_4 the 2-Sylow subgroup not cyclic and $\overline{\mathbb{F}}_2[V_4]$ has infinitely many indecomposables as listed in [Example 8.5](#).

Recall that a finite dimensional Hopf algebra A is, by definition, a Hopf algebra $A = (A, m, i, d, e, s)$ in $\mathbf{fdVec}_{\mathbb{S}}$, and $\mathbf{fdMod}(A)$ is its module category in $\mathbf{fdVec}_{\mathbb{S}}$. The version for Hopf algebras, where finite representation type means that $\#\mathbf{In}(\mathbf{fdMod}(A)) < \infty$, is:

Proposition 8.9 *Let A be a finite dimensional Hopf algebra. Then:*

- (a) We have $\mathbf{fdMod}(A) \in \mathbf{wTen}$. { dir L; $\leq m$ abelian
- (b) We have $\mathbf{fdMod}(A) \in \mathbf{wFiat}$ if and only if A is of finite representation type. ⊕

Proof. All discussion above works for finite dimensional Hopf algebras in general, not just for finite groups: By [Theorem 5.58](#) we know that $\mathbf{fdMod}(A)$ is rigid, and its also clearly \mathbb{S} linear and abelian with \mathbb{S} bilinear \otimes . Moreover, (8-1) holds for any finite dimensional algebra, so $\mathbf{fdMod}(A)$ is always finite, and additively finite if and only if A is of finite representation type, by definition. Moreover, A has a trivial module $\mathbb{1}$ obtained by using the counit $e: A \rightarrow \mathbb{S}$, and $\mathbb{1}$ is the monoidal unit of $\mathbf{fdMod}(A)$ giving $\mathbf{End}_{\mathbf{fdMod}(A)}(\mathbb{1}) \cong \mathbb{S}$. □

Thus, fiat and tensor categories can be seen as generalizations of Hopf algebras.

8C. Non-negative integral matrices. The arguably most important numerical invariant associated to a fiat (or tensor category) \mathbf{C} are integral matrices.

Definition 8.10 *Let $\mathbf{C} \in \mathbf{wmFiat}$. Then, for $i, j, k \in \{1, \dots, n\}$, the fusion rules and the fusion coefficients $N_{i,j}^k \in \mathbb{N}$ are*

$$Z_i Z_j \cong \bigoplus_{k=1}^n N_{i,j}^k Z_k, \text{ where } Z_l \in \mathbf{In}(\mathbf{C}).$$

Thus, the fusion coefficients are the structure constants of the \mathbb{Z} algebra $K_0^\oplus(\mathbf{C})$. These are most conveniently collected in the fusion matrices:

$$K_0^\oplus(- \otimes Z_j) = M(j) = (N_{i,j}^k)_{i,k=1}^n = \begin{matrix} & \begin{matrix} Z_1 & \dots & Z_i & \dots & Z_n \end{matrix} \\ \begin{matrix} Z_1 \\ \vdots \\ Z_k \\ \vdots \\ Z_n \end{matrix} & \left(\begin{array}{c} \text{---} \\ \text{---} \\ \text{---} \\ \text{---} \\ \text{---} \end{array} \right) & \in \mathbf{Mat}_{n \times n}(\mathbb{N}). \end{matrix}$$

$Z_i Z_j$

$Z_i Z_j \rightarrow$

$\Gamma_i \rightarrow \bigoplus Z_i$

In words, the fusion matrix $M(j)$ captures the right \otimes action of Z_j on \mathbf{C} . Recall further that we can associate a graph $\Gamma(M)$ with n vertices to each matrix $M \in \mathbf{Mat}_{n \times n}(\mathbb{N})$, see [Convention 8.1](#), which we identify with M . Thus, we have another numerical invariant of fiat categories which captures all the fusion rules:

Definition 8.11 *Let $\mathbf{C} \in \mathbf{wmFiat}$. Then, for $i \in \{1, \dots, n\}$, the fusion graphs are the directed graphs $\Gamma_i = \Gamma(M(i))$, i.e. the graphs associated to the fusion matrices.*

Similarly, the fusion graph of $X \in \mathbf{C}$ is the directed graph Γ_X associated to the right \otimes action of X on \mathbf{C} .

The following is evident, where the sum of graphs is the graph one gets summing the corresponding matrices, using the identification of these, cf. [Convention 8.1](#).

Lemma 8.12 *Let $\mathbf{C} \in \mathbf{wmFiat}$. If $X \in \mathbf{C}$ decomposes as $X \cong \bigoplus_{i=1}^n (X : Z_i) \cdot Z_i$, then $\Gamma_X = \sum_{i=1}^n (X : Z_i) \cdot \Gamma_i$. □*

The fusion graphs are invariants:

Proposition 8.13 *Let $F \in \mathbf{Hom}_{k \oplus \star}(\mathbf{C}, \mathbf{D})$ be an equivalence of categories $\mathbf{C}, \mathbf{D} \in \mathbf{wmFiat}$. Then, up to reordering, the fusion graphs of \mathbf{C} and \mathbf{D} are isomorphic as graphs.*

Proof. By [Proposition 7.50](#). □

Note that the fusion graph $\Gamma_{\mathbb{1}}$ associated to the monoidal unit $\mathbb{1}$ is always a completely disconnected graph with one loop per vertex, e.g.

$$\Gamma_{\mathbb{1}} = \begin{pmatrix} 1 & 0 & 0 & 0 \\ 0 & 1 & 0 & 0 \\ 0 & 0 & 1 & 0 \\ 0 & 0 & 0 & 1 \end{pmatrix} = \begin{matrix} \underbrace{\quad}_{Z_1} & \underbrace{\quad}_{Z_2} \\ \underbrace{\quad}_{Z_4} & \underbrace{\quad}_{Z_3} \end{matrix} \cdot$$

We call these the trivial fusion graphs, and all the others non-trivial. Moreover, in tables we omit the row and column for the fusion rules of $\mathbb{1}$ as they are trivial, see (8-3).

Example 8.14 *Let us consider two examples of semisimple fiat categories and their fusion graphs:*

(a) The category $\mathbf{fdMod}(\mathbb{C}[\mathbb{Z}/4\mathbb{Z}])$ has simples

$$L_1 = \mathbb{1} : \begin{pmatrix} 1 \\ \vdots \end{pmatrix}, \quad L_2 : \begin{pmatrix} i \\ \vdots \end{pmatrix}, \quad L_3 : \begin{pmatrix} -1 \\ \vdots \end{pmatrix}, \quad L_4 : \begin{pmatrix} -i \\ \vdots \end{pmatrix},$$

which act on $\mathbf{fdMod}(\mathbb{C}[\mathbb{Z}/4\mathbb{Z}])$ as the elements, in order, 0, 1, 2 and 3 in $\mathbb{Z}/4\mathbb{Z}$. Hence, the non-trivial fusion graphs are

$$\Gamma_1 = \begin{matrix} \mathbb{1} & \xrightarrow{\quad} & L_2 \\ \uparrow & & \downarrow \\ L_4 & \xleftarrow{\quad} & L_3 \end{matrix}, \quad \Gamma_2 = \begin{matrix} \mathbb{1} & \xrightarrow{\quad} & L_2 \\ \uparrow & \times & \downarrow \\ L_4 & \xleftarrow{\quad} & L_3 \end{matrix}, \quad \Gamma_3 = \begin{matrix} \mathbb{1} & \xrightarrow{\quad} & L_2 \\ \uparrow & & \downarrow \\ L_4 & \xrightarrow{\quad} & L_3 \end{matrix}.$$

(b) The category $\mathbf{fdMod}(\mathbb{C}[V_4])$ (Klein's four group, see [Example 8.5](#)) has simples also corresponding to the elements 1, s , t and $st = ts$ in V_4 . Hence, the non-trivial fusion graphs are

$$\Gamma_s = \begin{matrix} \mathbb{1} & \xrightarrow{\quad} & L_s \\ \uparrow & \times & \downarrow \\ L_t & \xrightarrow{\quad} & L_{ts} \end{matrix}, \quad \Gamma_t = \begin{matrix} \mathbb{1} & \xrightarrow{\quad} & L_s \\ \uparrow & & \downarrow \\ L_t & \xrightarrow{\quad} & L_{ts} \end{matrix}, \quad \Gamma_{st} = \begin{matrix} \mathbb{1} & \xrightarrow{\quad} & L_s \\ \uparrow & \times & \downarrow \\ L_t & \xrightarrow{\quad} & L_{ts} \end{matrix}.$$

Thus, although $\mathbf{fdMod}(\mathbb{C}[\mathbb{Z}/4\mathbb{Z}])$ and $\mathbf{fdMod}(\mathbb{C}[V_4])$ are equivalent as categories, they are not equivalent as fiat categories.

Example 8.15 Let S_3 be the symmetric group in three letters, which is of order 6. The category $\mathbf{fdMod}(\mathbb{C}[S_3])$ is a semisimple fiat category with simples $L_1 = \mathbb{1}$, L_s and L_{-1} satisfying the following fusion rules:

$$(8-3) \quad \begin{array}{c|c|c} \otimes & L_s & L_{1'} \\ \hline L_s & L_1 \oplus L_s \oplus L_{1'} & L_s \\ \hline L_{1'} & L_s & L_1 \end{array} \left(= \begin{array}{c|c|c|c} \otimes & L_1 & L_s & L_{1'} \\ \hline L_1 & L_1 & L_s & L_{1'} \\ \hline L_s & L_s & L_1 \oplus L_s \oplus L_{1'} & L_s \\ \hline L_{1'} & L_{1'} & L_s & L_1 \end{array} \right).$$

Thus, we get the non-trivial fusion graphs

$$\Gamma_s = \begin{pmatrix} \mathbb{1} & 1 & 1 \\ 1 & 1 & 1 \\ 0 & 1 & 1 \end{pmatrix} = \mathbb{1} \begin{array}{c} \xrightarrow{\text{blue}} L_s \xrightarrow{\text{orange}} L_{1'} \\ \xleftarrow{\text{green}} L_s \xleftarrow{\text{red}} L_{1'} \\ \uparrow \downarrow \end{array}, \quad \Gamma_{1'} = \begin{pmatrix} 0 & 0 & 1 \\ 0 & 1 & 0 \\ 1 & 0 & 0 \end{pmatrix} = \mathbb{1} \begin{array}{c} \xleftrightarrow{\text{blue}} L_s \xleftrightarrow{\text{orange}} L_{1'} \\ \xleftarrow{\text{green}} L_s \xleftarrow{\text{red}} L_{1'} \\ \uparrow \downarrow \end{array}.$$

Example 8.16 The fusion graphs are certainly not a complete invariant of fiat categories as they do not involve the morphisms in any way. To be completely explicit, the categories of the form $\mathbf{Vec}_{\mathbb{K} \oplus}^\omega(G)$, for G being a finite group, are fiat categories with the same fusion graphs, independent of ω .

Recall that strongly connected for graphs means connected as a directed graph.

Definition 8.17 Let $\mathbf{C} \in \mathbf{wmFiat}$. We call $X \in \mathbf{C}$ a fusion generator of \mathbf{C} if Γ_X is strongly connected. In case $\mathbf{C} \in \mathbf{wmFiat}$ has a fusion generator, we call \mathbf{C} transitive.

Example 8.18 In Example 8.14.(a) both, L_1 and L_3 , are fusion generators, but L_2 is not a fusion generator. In Example 8.14.(b) none of the simples are fusion generators, but

$$L_s \oplus L_t \rightsquigarrow \Gamma_{L_s \oplus L_t} = \begin{pmatrix} 0 & 1 & 1 & 0 \\ 1 & 0 & 0 & 1 \\ 1 & 0 & 0 & 1 \\ 0 & 1 & 1 & 0 \end{pmatrix} = \begin{array}{ccc} \mathbb{1} & \xleftrightarrow{\text{blue}} & L_s \\ \uparrow & & \uparrow \\ L_t & \xleftrightarrow{\text{orange}} & L_{ts} \end{array} \quad \checkmark$$

is a fusion generator.

The term “generator” is to be understood in this sense:

Lemma 8.19 Let $\mathbf{C} \in \mathbf{wmFiat}$ be transitive, $X \in \mathbf{C}$ be a fusion generator and $Y \in \mathbf{C}$ any object. Then there exist $k \in \mathbb{N}$ such that $Y \in X^k$.

$$Y \in X \oplus \dots \oplus X$$

Proof. If X and Y are indecomposable, then k can be taken to be the length of a shortest path in Γ_X from the vertex corresponding to X to the vertex corresponding to Y . For general X and Y the claim follows thus by additivity. \square

8D. **Perron–Frobenius.** The classical Perron–Frobenius (PF for short) theorem is one of the cornerstones of linear algebra, very useful in many areas of mathematics and will turn out to be of crucial importance for us as well. Here it is:

Theorem 8.20 Let $M \in \text{Mat}_{n \times n}(\mathbb{R}_{\geq 0})$. Then: non-negative $\mathbb{R}_{\geq 0}$

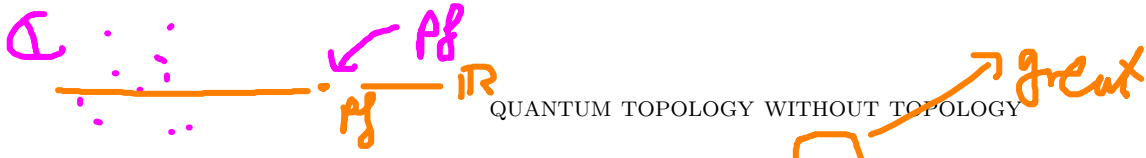

(i) The matrix M has an eigenvalue $\lambda_{pf}(M) \in \mathbb{R}_{\geq 0}$ which satisfies

$$(8-4) \quad |\lambda_{pf}(M)| \geq |\mu|, \quad \text{for all eigenvalues } \mu \text{ of } M.$$

Moreover, M has an eigenvector $v_{pf}(M)$ with eigenvalue $\lambda_{pf}(M)$, which can be normalized such that $v_{pf}(M) \in \mathbb{R}_{\geq 0}^n$.

(ii) If additionally $M \in \text{Mat}_{n \times n}(\mathbb{R}_{>0})$, then $\lambda_{pf}(M) \in \mathbb{R}_{>0}$, $v_{pf}(M) \in \mathbb{R}_{>0}^n$ (after normalization), the eigenvalue $\lambda_{pf}(M)$ is simple, and the inequality in (8-4) is strict. Further, the eigenvector $v_{pf}(M)$ is the unique (up to scaling) eigenvector of M with values in $\mathbb{R}_{>0}$.

$\lambda_{pf}(M)$ is called the PF eigenvalue of M , and $v_{pf}(M)$ is called the PF eigenvector of M .

Proof. (i)-Existence. The idea is to use Brouwer's fixed-point theorem. Assume that M does not have an eigenvector $v_0(M) \in \mathbb{R}_{\geq 0}^n$ of eigenvalue zero. Then, since there are no cancellations due to non-negativity,

$$f: \Sigma_n \rightarrow \Sigma_n, \quad v \mapsto \frac{Mv}{\sum_{i=1}^n (Mv)_i}$$

defines a continuous map from the standard n simplex $\Sigma_n = \{v \in \mathbb{R}_{\geq 0}^n \mid \sum_{i=1}^n v_i = 1\}$ to itself. Thus, Brouwer's fixed-point theorem gives us a fixed point w of f , which, by construction, satisfies

$$Mw = \mu w, \quad \text{where } \mu \in \mathbb{R}_{\geq 0}, w \in \mathbb{R}_{\geq 0}^n.$$

We can hence define $\lambda_{pf}(M)$ to be the maximal eigenvalue of M having a non-negative eigenvector $v_{pf}(M)$. Since this also works in case M does have an eigenvector $v_0(M) \in \mathbb{R}_{\geq 0}^n$ of eigenvalue zero, we have now constructed the required eigenvalue and eigenvector, and it remains to show the claimed properties.

(ii)-Positivity. If $M \in \text{Mat}_{n \times n}(\mathbb{R}_{>0})$, then the just constructed eigenvalue $\lambda_{pf}(M)$ and eigenvector $v_{pf}(M)$ are also strictly positive.

(ii)-Simplicity. The eigenvalue $\lambda_{pf}(M)$ is simple: If $w \in \mathbb{R}^n$ is another eigenvector of $\lambda_{pf}(M)$, then define $z = \min\{w_i - v_{pf}(M)_i \mid i = 1, \dots, n\}$. Now we observe that $w - z \cdot v_{pf}(M) \in \mathbb{R}_{\geq 0}^n$ is another eigenvector of M with eigenvalue $\lambda_{pf}(M)$. However, this, by positivity, implies that $w - z \cdot v_{pf}(M) = 0$ as it has at least one entry being zero. Thus, $\lambda_{pf}(M)$ is simple.

(ii)-Uniqueness. Assume now that there exist another strictly positive eigenvector w with eigenvalue μ , and let $v_{pf}(M^T)$ denote the PF eigenvector of $v_{pf}(M^T)$. Then $\lambda_{pf}(M)v_{pf}(M^T)w = v_{pf}(M^T)Mw = \mu v_{pf}(M^T)w$, which, by positivity, implies that $\mu = \lambda_{pf}(M)$. Hence, we also have $w = v_{pf}(M^T)$, by simplicity.

(ii)-Inequality. For $w \in \mathbb{C}^n$ let $|w| = \sum_{i=1}^n |w_i|v_{pf}(M)_i$. Then one checks that $|Mw| \leq \lambda_{pf}(M)|w|$ and equality holds if and only if all non-zero entries of w have the same argument. Hence, if w is an eigenvector of M with eigenvalue μ , then $|\mu||w| \leq \lambda_{pf}(M)|w|$, which implies that $|\mu| \leq \lambda_{pf}(M)$. Finally, if $|\mu| = \lambda_{pf}(M)$, then all non-zero entries of w have the same argument and we can normalize w to be strictly positive. Hence, $\mu = \lambda_{pf}(M)$, by uniqueness.

(i)-Rest. Using (ii) and

$$M_N = M + \frac{1}{N} \begin{pmatrix} 1 & \dots & 1 \\ \vdots & \ddots & \vdots \\ 1 & \dots & 1 \end{pmatrix} \in \text{Mat}_{n \times n}(\mathbb{R}_{>0}), \quad \lim_{N \rightarrow \infty} M_N = M,$$

this is an easy limit argument.

□

Remark 8.21 If one works over $\mathbb{Q}_{\geq 0}$ instead of $\mathbb{R}_{\geq 0}$, then there is an alternative and constructive proof of the PF theorem. (This is a consequence of Barr's theorem [Ba74].)

Example 8.22 Note the difference between strictly positive and positive, and various other properties as e.g. "converting to zero" or "nilpotent":

$$M_1 = \begin{pmatrix} \frac{1}{3} & \frac{1}{3} \\ \frac{1}{3} & \frac{1}{3} \end{pmatrix}, \quad M_2 = \begin{pmatrix} \frac{1}{3} & 0 \\ \frac{1}{3} & \frac{1}{3} \end{pmatrix}, \quad M_3 = \begin{pmatrix} 0 & 0 \\ \frac{1}{3} & 0 \end{pmatrix},$$

Let us call them "Case 1", "Case 2" and "Case 3", respectively. Then:

$$\text{Case 1: } \begin{cases} \lambda_{pf} = \frac{2}{3}, & v_{pf} = (1, 1), \\ \mu_1 = 0, & v_1 = (-1, 1), \end{cases} \quad \text{Case 2: } \begin{cases} \lambda_{pf} = \frac{1}{3}, \\ v_{pf} = (0, 1), \end{cases} \quad \text{Case 3: } \begin{cases} \lambda_{pf} = 0, \\ v_{pf} = (1, 0). \end{cases}$$

Here is the version of the PF theorem for positive integral matrices, a.k.a. graphs, which has slightly better statements:

Theorem 8.23 Let $\Gamma \in \text{Mat}_{n \times n}(\mathbb{N})$. Then the PF theorem Theorem 8.20 applies and we have additionally:

- (i) If Γ has a directed cycle, then $\lambda_{pf}(M) \in \mathbb{R}_{\geq 1}$.
- (ii) If Γ is strongly connected, then $\lambda_{pf}(\Gamma) \in \mathbb{R}_{\geq 1}$, $v_{pf}(M) \in \mathbb{R}_{> 0}^n$ (after normalization), and all μ satisfying equality in (8-4) are not in $\mathbb{R}_{> 0}$. Further, the only strictly positive eigenvectors of M are of eigenvalue $\lambda_{pf}(M)$.



Proof. Note that Γ^k counts the number of paths of length k in Γ .

(i). As Γ has an oriented cycle, $\Gamma^k \neq 0$ for all $k \in \mathbb{N}$. Moreover, since Γ has entries from \mathbb{N} we also know that $\lim_{k \rightarrow \infty} \Gamma^k \neq 0$. This implies that the PF eigenvalue has to be at least 1.

(ii). We get a strictly positive matrix

$$T = f(\Gamma) = \sum_{i=0}^n \Gamma^i \in \text{Mat}_{n \times n}(\mathbb{N}_{> 0}), \quad \text{where } f(X) = \sum_{i=0}^n X^i.$$

Hence, we can apply Theorem 8.20.(ii) to T , and simultaneously Theorem 8.20.(i) to Γ . These imply that $\sum_{i=1}^n \lambda_{pf}(\Gamma)^i = \lambda_{pf}(T)$, thus $\lambda_{pf}(\Gamma) \in \mathbb{R}_{\geq 1}$, and moreover $v_{pf}(\Gamma) = v_{pf}(T) \in \mathbb{R}_{> 0}^n$. The other claims follow by observing that the non-zero roots of $f(X)$ are the n th complex roots of unity. \square

Example 8.24 Let $\Gamma_1, \Gamma_s \in \text{Mat}_{3 \times 3}(\mathbb{N})$ be

$$\Gamma_1 = \begin{pmatrix} 0 & 0 & 1 \\ 1 & 0 & 0 \\ 0 & 1 & 0 \end{pmatrix} = \begin{matrix} & 0 & \xrightarrow{\quad} & 1 \\ & \swarrow & & \searrow \\ & & 2 & \\ & \swarrow & & \searrow \end{matrix}, \quad \Gamma_s = \begin{pmatrix} 0 & 1 & 0 \\ 1 & 1 & 1 \\ 0 & 1 & 0 \end{pmatrix} = 1 \begin{matrix} \xrightarrow{\quad} & s & \xrightarrow{\quad} & 1' \\ \cup & & & \end{matrix}$$

(These are action matrices of fusion generators of $\text{fdMod}(\mathbb{C}[\mathbb{Z}/3\mathbb{Z}])$ and $\text{fdMod}(\mathbb{C}[S_3])$, respectively.) Let us call them "Case 1" and "Case 2". The eigenvalues and eigenvectors in these two cases are:

$$\text{Case 1: } \begin{cases} \lambda_{pf} = 1, & v_{pf} = (1, 1, 1), \\ \mu_1 = \frac{1}{2}(-1 + i\sqrt{3}), & v_1 = (\frac{1}{2}(-1 + i\sqrt{3}), \frac{1}{2}(-1 - i\sqrt{3}), 1), \\ \mu_2 = \frac{1}{2}(-1 - i\sqrt{3}), & v_2 = (\frac{1}{2}(-1 - i\sqrt{3}), \frac{1}{2}(-1 + i\sqrt{3}), 1), \end{cases}$$

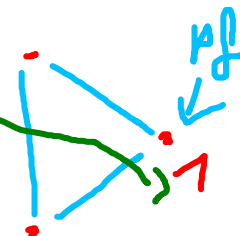

$$\text{Case 2: } \begin{cases} \lambda_{pf} = 2, & v_{pf} = (1, 2, 1), \\ \mu'_1 = -1, & v_1 = (1, -1, 1), \\ \mu'_2 = 0, & v_2 = (-1, 0, 1). \end{cases}$$

Note that $|\mu_1| = |\mu_2| = \lambda_{pf} = 1$, but neither μ_1 nor μ_2 are real numbers.

By Proposition 8.13, we get the following invariants of fiat categories.

Definition 8.25 Let $\mathbf{C} \in \mathbf{wmFiat}$ and $\mathbf{X} \in \mathbf{C}$. The **PF dimension** of \mathbf{X} is $\text{PFdim}(\mathbf{X}) = \lambda_{pf}(\Gamma_{\mathbf{X}})$. The **PF dimension** of \mathbf{C} is $\text{PFdim}(\mathbf{C}) = \sum_{i=1}^n \text{PFdim}(\mathbf{Z}_i)^2$. dim L^2

Note that we always have $\text{PFdim}(\mathbb{1}) = 1$. (We will omit this case from examples.) However, PF dimensions need not to be integers:

Example 8.26 There exists a semisimple fiat category **Fib**, called **Fibonacci category**, which has two simple objects $L_1 = \mathbb{1}$ and $L_2 = L$ with

$$L^2 \cong \mathbb{1} \oplus L.$$

$$L^2 = \mathbb{1} \oplus L$$

Thus, letting $\phi = \frac{1}{2}(1 + \sqrt{5})$ denote the golden ratio, we get

$$\mathbb{1}L = L$$

$$\Gamma_L = \begin{pmatrix} 0 & 1 \\ 1 & 1 \end{pmatrix} = \mathbb{1} \begin{matrix} \xrightarrow{\quad} L \\ \xleftarrow{\quad} L \end{matrix} \Rightarrow \begin{cases} \lambda_{pf}(\Gamma_L) = \text{PFdim}(L) = \phi, \\ v_{pf}(\Gamma_L) = (\phi, 1), \\ \text{PFdim}(\mathbf{Fib}) = 1 + \phi^2 = \frac{1}{2}(5 + \sqrt{5}). \end{cases}$$

$$\text{pf}(\mathbb{1}) = 1$$

Lemma 8.27 Let $\mathbf{C} \in \mathbf{wmFiat}$. Then:

- (i) For $\mathbf{X}, \mathbf{Y} \in \mathbf{C}$ we have $\text{PFdim}(\mathbf{XY}) = \text{PFdim}(\mathbf{X})\text{PFdim}(\mathbf{Y})$.
- (ii) If $\mathbf{X} \in \mathbf{C}$ is invertible (see Definition 4.34), then $\text{PFdim}(\mathbf{X}) = 1$.
- (iii) For $\mathbf{X} \in \mathbf{C}$ we have $\text{PFdim}(\mathbf{X}^*) = \text{PFdim}(\mathbf{X}) = \text{PFdim}(*\mathbf{X})$. Moreover, all action matrices, $\Gamma_{\mathbf{X}^*}$, $\Gamma_{\mathbf{X}}$ and $\Gamma_{*\mathbf{X}}$, agree up to transposition and permutation.
- (iv) The self-dual object $\mathbf{T} \in \mathbf{C}$, called the **total object**, defined by

$$\mathbf{T} = \sum_{i=1}^n \mathbf{Z}_i$$

is a fusion generator of \mathbf{C} if and only if \mathbf{C} is transitive.

- (v) If \mathbf{C} is transitive, then there exists a strictly positive virtual object $\mathbf{R} \in \mathbf{C}$ (meaning a formal $\mathbb{R}_{>0}$ linear combination of indecomposables), called the **regular object**, which is the, up to scaling, unique object satisfies the equality

$$[\mathbf{XR}] = [\mathbf{RX}] = \text{PFdim}(\mathbf{X}) \cdot [\mathbf{R}], \quad (\text{in } K_0^{\oplus}(\mathbf{C}) \otimes_{\mathbb{Z}} \mathbb{C}),$$

for all $\mathbf{X} \in \mathbf{C}$.

- (vi) We have $\text{PFdim}(\mathbf{C}) = \text{PFdim}(\mathbf{R})$.

As we will see in e.g. Example 8.29(i), all of this should be thought of as generalizing very familiar notions from representation theory of groups.

Proof. (i). This follows since the PF eigenvalue is multiplicative.

(ii). As an invertible object can not have a nilpotent action matrix this follows from (i) and $\text{PFdim}(X) \geq 1$, see [Theorem 8.23](#).(i).

(iii). By [Lemma 7.22](#).(iii), the functor $-^*$ preserves the property of being indecomposable and induces a bijection as in (7-7). In other words, duality acts as a permutation on the set of indecomposable objects. Thus, $(ZX)^* \cong (X^*)(Z^*)$ shows that, up to permutation, the action matrix for X^* is the transpose of the action matrix for X , which implies that $\text{PFdim}(X^*) = \text{PFdim}(X)$. The other claim follows by symmetry.

(iv). The second claim is clear by additivity, the first, that T is self-dual, follows from the bijections as in (7-7).

(v). Since C is transitive, the total object T is a fusion generator, see (iv). By [Theorem 8.20](#).(iii), we can thus take $[R] = v_{pf}(\Gamma_T)$, which is unique up to scaling and strictly positive. Hence, we can interpret R as a strictly positive sum of indecomposables of C . By this construction and [Theorem 8.20](#).(iii) it follows that $[XR]$ and $[RX]$ must be proportional to $[R]$. To see this observe that $[XR]\Gamma_T = \lambda_{pf}(T) \cdot [XR] = \Gamma_T[RX]$. (Note that Γ_T is symmetric by (iv).) This implies that $[XR]$ and $[RX]$ are strictly positive eigenvectors of Γ_T , and the claim follows from [Theorem 8.20](#).(iii).

(vi). Clear by additivity of the PF eigenvalue. □

A crucial feature of PF dimensions is that they come in discrete values:

Proposition 8.28 *Let $C \in \mathbf{wmFiat}$ and $X \in C$. Then the PF dimensions $\text{PFdim}(X)$ and $\text{PFdim}(C)$ are algebraic integers, i.e. roots of some $p \in \mathbb{Z}[X]$, and ≥ 1 .*

Proof. To show that they are algebraic integers we can take $p \in \mathbb{Z}[X]$ to be the characteristic polynomial of Γ_X , and the claim for C follows by additivity. For the second claim we observe that $\text{PFdim}(X)^2 = \text{PFdim}(XX^*)$, by [Lemma 8.27](#).(i), and $\text{PFdim}(XX^*) \geq 1$ by [Theorem 8.23](#).(i): Γ_{XX^*} can not be a nilpotent matrix as there should always be a non-degenerate (co)pairing to $\mathbb{1}$. Hence, $\text{PFdim}(X) \geq 1$ which finishes the proof since, as before, the statement for C follows by additivity. □

Example 8.29 *Let S_3 be the symmetric group in three letters, which is of order 6, and let \mathbb{K} be algebraically closed. By [Proposition 8.6](#).(iii) we know that $\mathbf{fdMod}(\mathbb{K}[S_3])$ is fiat, and by [Example 7.37](#) it is semisimple if and only if the characteristic of \mathbb{K} is not 2 or 3. So we basically have three cases:*

(I) *The case $\mathbb{K} = \mathbb{C}$, which we already glimpsed upon in [Example 8.15](#). In this case we get $L_1 = \mathbb{1}$ and*

$$\text{PFdim}(L_s) = \text{PFdim}\left(\begin{pmatrix} 0 & 1 & 0 \\ 1 & 1 & 1 \\ 0 & 1 & 0 \end{pmatrix}\right) = 2, \quad \text{PFdim}(L_{1'}) = \text{PFdim}\left(\begin{pmatrix} 0 & 0 & 1 \\ 0 & 1 & 0 \\ 1 & 0 & 0 \end{pmatrix}\right) = 1,$$

$$T = \mathbb{1} \oplus L_s \oplus L_{1'}, \quad \Gamma_T = \begin{pmatrix} 1 & 1 & 1 \\ 1 & 3 & 1 \\ 1 & 1 & 1 \end{pmatrix} \iff \begin{array}{ccc} \mathbb{1} & \longleftrightarrow & L_{1'} \\ & \swarrow \quad \searrow & \\ & L_s & \\ & \uparrow & \\ & 3 & \end{array}$$

$$R = \mathbb{1} \oplus 2 \cdot L_s \oplus L_{1'} \cong \mathbb{C}[S_3], \quad \text{PFdim}(\mathbf{fdMod}(\mathbb{C}[S_3])) = 1 \cdot 1 + 2 \cdot 2 + 1 \cdot 1 = 6 = \text{PFdim}(R).$$

$$1^2 + 2^2 + 1^2 = 6$$

Note that the regular object is the regular representation of $\mathbb{C}[S_3]$ on itself, hence the name. The PF dimension in this case is the dimension of $\mathbb{C}[S_3]$, a.k.a. the order of S_3 .

(II) The case $\mathbb{K} = \overline{\mathbb{F}}_3$. We want to use the construction in Remark 8.7. First, we have a 3-Sylow subgroup $\mathbb{Z}/3\mathbb{Z}$ and we want to consider $\overline{\mathbb{F}}_3[\mathbb{Z}/3\mathbb{Z}]$. Similarly as for the case of $\mathbb{Z}/5\mathbb{Z}$, see e.g. Example 6.91, we get that $\overline{\mathbb{F}}_3[\mathbb{Z}/3\mathbb{Z}]$ has three indecomposable modules, given by Jordan blocks for the eigenvalue 1: a 1×1 Jordan block Z'_1 , a 2×2 Jordan block Z'_2 , and a 3×3 Jordan block $Z'_3 = \overline{\mathbb{F}}_3[\mathbb{Z}/3\mathbb{Z}]$. Let z be the basis element of Z'_1 , and let $1, s$ be the elements of $S_2 \cong S_3/(\mathbb{Z}/3\mathbb{Z})$. Then:

$$\overline{\mathbb{F}}_3[S_3] \otimes_{\overline{\mathbb{F}}_3[\mathbb{Z}/3\mathbb{Z}]} Z'_1 \cong Z_1 \oplus Z_{1'} \cong L_1 \oplus L_{1'}$$

for $L_1 \cong \mathbb{1}$ and $L_{1'}$ as in (I), which are also the only simples of $\overline{\mathbb{F}}_3[S_3]$. To see this we simply observe that we can base change

$$\overline{\mathbb{F}}_3[S_3] \otimes_{\overline{\mathbb{F}}_3[\mathbb{Z}/3\mathbb{Z}]} Z'_1 = \overline{\mathbb{F}}_3\{1 \otimes z, s \otimes z\} = \overline{\mathbb{F}}_3\{\frac{1}{2}(1+s) \otimes z, \frac{1}{2}(1-s) \otimes z\}.$$

(Also recall the idempotents e_{\pm} from Example 7.9.) Moreover, we see analogously that

$$\overline{\mathbb{F}}_3[S_3] \otimes_{\overline{\mathbb{F}}_3[\mathbb{Z}/3\mathbb{Z}]} Z'_2 \cong Z_2 \oplus Z_{2'}, \quad \overline{\mathbb{F}}_3[S_3] \otimes_{\overline{\mathbb{F}}_3[\mathbb{Z}/3\mathbb{Z}]} Z'_3 \cong P(L_1) \oplus P(L_{1'}) \cong Z_3 \oplus Z_{3'},$$

which are all of the indicated dimensions. Summarized:

$$\begin{aligned} \text{Si}(\text{fdMod}(\overline{\mathbb{F}}_3[S_3])) &= \{Z_1 \cong \mathbb{1}, Z_{1'} = L_{1'}\}, & \text{Pi}(\text{fdMod}(\overline{\mathbb{F}}_3[S_3])) &= \{Z_3 \cong P_{\mathbb{1}}, Z_{3'} \cong P_{1'}\}, \\ \text{In}(\text{fdMod}(\overline{\mathbb{F}}_3[S_3])) &= \{Z_1, Z_{1'}, Z_2, Z_{2'}, Z_3, Z_{3'}\}, & \dim(Z_i) = i &= \dim(Z_{i'}). \end{aligned}$$

To be more explicit, the Jordan–Hölder filtration are of the form

$$\begin{aligned} Z_1 &\cong \mathbb{1} \text{ is simple}, & Z_{1'} = L_{1'} &\text{ is simple,} \\ 0 &- \mathbb{1} - L_{1'} - Z_2, & 0 &- L_{1'} - \mathbb{1} - Z_{2'}, \\ 0 &- \mathbb{1} - L_{1'} - \mathbb{1} - Z_3, & 0 &- L_{1'} - \mathbb{1} - L_{1'} - Z_{3'} \end{aligned}$$

These satisfy the fusion rules:

\otimes	Z_2	$P_{\mathbb{1}}$	$P_{1'}$	$Z_{2'}$	$L_{1'}$
Z_2	$P_{\mathbb{1}} \oplus L_{1'}$	$P_{\mathbb{1}} \oplus P_{1'}$	$P_{\mathbb{1}} \oplus P_{1'}$	$\mathbb{1} \oplus P_{1'}$	$Z_{2'}$
$P_{\mathbb{1}}$	$P_{\mathbb{1}} \oplus P_{1'}$	$P_{\mathbb{1}} \oplus P_{1'} \oplus P_{\mathbb{1}}$	$P_{1'} \oplus P_{\mathbb{1}} \oplus P_{1'}$	$P_{\mathbb{1}} \oplus P_{1'}$	$P_{1'}$
$P_{1'}$	$P_{\mathbb{1}} \oplus P_{1'}$	$P_{1'} \oplus P_{\mathbb{1}} \oplus P_{1'}$	$P_{\mathbb{1}} \oplus P_{1'} \oplus P_{\mathbb{1}}$	$P_{\mathbb{1}} \oplus P_{1'}$	$P_{\mathbb{1}}$
$Z_{2'}$	$\mathbb{1} \oplus P_{1'}$	$P_{\mathbb{1}} \oplus P_{1'}$	$P_{\mathbb{1}} \oplus P_{1'}$	$P_{\mathbb{1}} \oplus L_{1'}$	Z_2
$L_{1'}$	$Z_{2'}$	$P_{1'}$	$P_{\mathbb{1}}$	Z_2	$\mathbb{1}$

Thus, the action matrices and their PF eigenvalues and eigenvectors are:

$$\Gamma_1 = \begin{pmatrix} 1 & 0 & 0 & 0 & 0 & 0 \\ 0 & 1 & 0 & 0 & 0 & 0 \\ 0 & 0 & 1 & 0 & 0 & 0 \\ 0 & 0 & 0 & 1 & 0 & 0 \\ 0 & 0 & 0 & 0 & 1 & 0 \\ 0 & 0 & 0 & 0 & 0 & 1 \end{pmatrix}, \Gamma_{1'} = \begin{pmatrix} 0 & 0 & 0 & 0 & 0 & 1 \\ 0 & 0 & 0 & 0 & 1 & 0 \\ 0 & 0 & 0 & 1 & 0 & 0 \\ 0 & 0 & 1 & 0 & 0 & 0 \\ 0 & 1 & 0 & 0 & 0 & 0 \\ 1 & 0 & 0 & 0 & 0 & 0 \end{pmatrix}, \begin{aligned} \lambda_{pf}(\Gamma_1) &= 1, \\ v_{pf}(\Gamma_1) &= (1, 1, 1, 1, 1, 1), \\ \lambda_{pf}(\Gamma_{1'}) &= 1, \\ v_{pf}(\Gamma_{1'}) &= (1, 1, 1, 1, 1, 1), \end{aligned}$$

$\leftarrow pf$
 $(1, -1)$
 $2 + 8 + 18 = 28$
 $2 \cdot 1^2 + 2 \cdot 2^2 + 2 \cdot 3^2$

$$\begin{aligned}
 \Gamma_2 &= \begin{pmatrix} 0 & 0 & 0 & 0 & 1 & 0 \\ 1 & 0 & 0 & 0 & 0 & 0 \\ 0 & 1 & 1 & 1 & 0 & 0 \\ 0 & 0 & 1 & 1 & 1 & 0 \\ 0 & 0 & 0 & 0 & 0 & 1 \\ 0 & 1 & 0 & 0 & 0 & 0 \end{pmatrix}, \Gamma_{2'} = \begin{pmatrix} 0 & 1 & 0 & 0 & 0 & 0 \\ 0 & 0 & 0 & 0 & 0 & 1 \\ 0 & 0 & 1 & 1 & 1 & 0 \\ 0 & 1 & 1 & 1 & 0 & 0 \\ 1 & 0 & 0 & 0 & 0 & 0 \\ 0 & 0 & 0 & 0 & 1 & 0 \end{pmatrix}, \\
 \Gamma_3 &= \begin{pmatrix} 0 & 0 & 0 & 0 & 0 & 0 \\ 0 & 0 & 0 & 0 & 0 & 0 \\ 1 & 1 & 2 & 1 & 1 & 0 \\ 0 & 1 & 1 & 2 & 1 & 1 \\ 0 & 0 & 0 & 0 & 0 & 0 \\ 0 & 0 & 0 & 0 & 0 & 0 \end{pmatrix}, \Gamma_{3'} = \begin{pmatrix} 0 & 0 & 0 & 0 & 0 & 0 \\ 0 & 0 & 0 & 0 & 0 & 0 \\ 0 & 1 & 1 & 2 & 1 & 1 \\ 1 & 1 & 2 & 1 & 1 & 0 \\ 0 & 0 & 0 & 0 & 0 & 0 \\ 0 & 0 & 0 & 0 & 0 & 0 \end{pmatrix},
 \end{aligned}$$

$\lambda_{pf}(\Gamma_2) = 2,$
 $v_{pf}(\Gamma_2) = (0, 0, 1, 1, 0, 0),$
 $\lambda_{pf}(\Gamma_{2'}) = 2,$
 $v_{pf}(\Gamma_{2'}) = (0, 0, 1, 1, 0, 0),$
 $\lambda_{pf}(\Gamma_3) = 3,$
 $v_{pf}(\Gamma_3) = (0, 0, 1, 1, 0, 0),$
 $\lambda_{pf}(\Gamma_{3'}) = 3,$
 $v_{pf}(\Gamma_{3'}) = (0, 0, 1, 1, 0, 0).$

Note that none of the indecomposables are fusion generators, and only the one dimensional ones are invertible. The total and regular objects are also not fusion generators:

$$\Gamma_T = \begin{pmatrix} 1 & 1 & 0 & 0 & 1 & 1 \\ 1 & 1 & 0 & 0 & 1 & 1 \\ 1 & 3 & 6 & 6 & 3 & 1 \\ 1 & 3 & 6 & 6 & 3 & 1 \\ 1 & 1 & 0 & 0 & 1 & 1 \\ 1 & 1 & 0 & 0 & 1 & 1 \end{pmatrix}, \Gamma_R = \begin{pmatrix} 1 & 2 & 0 & 0 & 2 & 1 \\ 2 & 1 & 0 & 0 & 1 & 2 \\ 3 & 8 & 14 & 14 & 8 & 3 \\ 3 & 8 & 14 & 14 & 8 & 3 \\ 2 & 1 & 0 & 0 & 1 & 2 \\ 1 & 2 & 0 & 0 & 2 & 1 \end{pmatrix},$$

$\lambda_{pf}(\Gamma_T) = 12,$
 $v_{pf}(\Gamma_T) = (0, 0, 1, 1, 0, 0),$
 $\lambda_{pf}(\Gamma_R) = 28,$
 $v_{pf}(\Gamma_R) = (0, 0, 1, 1, 0, 0).$

The PF dimension of the category itself is $\text{PFdim}(\mathbf{C}) = \text{PFdim}(\mathbf{R}) = 28.$

(III) The case $\mathbb{K} = \overline{\mathbb{F}}_2$ works mutatis mutandis as (II) above. Doing the calculations gives four indecomposable modules $Z_1 = L_1 \cong \mathbb{1}$, $Z_2 = L_s$, $Z_3 \cong P_1$ and $Z_{3'} \cong P_s$, which are of the indicated dimensions. The fusion rules are:

\otimes	L_s	P_1	P_s
L_s	$L_1 \oplus P_1$	$P_1 \oplus P_s$	$P_1 \oplus P_1$
P_1	$P_1 \oplus P_s$	$2 \cdot P_1 \oplus P_s$	$P_1 \oplus 2 \cdot P_s$
P_s	$P_1 \oplus P_1$	$P_1 \oplus 2 \cdot P_s$	$2 \cdot P_1 \oplus P_s$

To compute the PF dimensions etc. is Exercise 8.59.

← all you need for

Example 8.30 Let us again consider S_3 , but now rather the category $\text{Vec}_{\mathbb{K}^\oplus}^\omega(S_3)$, for any 3 cocycle ω . Let $S_3 = \{1, s, t, ts, st, sts = tst\}$, where, in graphical notation,

$$1 = \begin{array}{|c|} \hline | \\ \hline \end{array}, s = \begin{array}{|c|} \hline \diagdown \quad \diagup \\ \hline \end{array}, t = \begin{array}{|c|} \hline \diagup \quad \diagdown \\ \hline \end{array}, ts = \begin{array}{|c|} \hline \diagdown \quad \diagup \\ \hline \end{array}, st = \begin{array}{|c|} \hline \diagup \quad \diagdown \\ \hline \end{array}, sts = \begin{array}{|c|} \hline \diagdown \quad \diagup \\ \hline \end{array} = \begin{array}{|c|} \hline \diagup \quad \diagdown \\ \hline \end{array} = tst.$$

By definition, the fusion rules of $\text{Vec}_{\mathbb{K}^\oplus}^\omega(S_3)$ are exactly the multiplication rules of S_3 . Thus, the action matrices are just permutation matrices, e.g.

$$\Gamma_{st} = \begin{pmatrix} 0 & 0 & 0 & 1 & 0 & 0 \\ 0 & 0 & 0 & 0 & 0 & 1 \\ 0 & 1 & 0 & 0 & 0 & 0 \\ 0 & 0 & 0 & 0 & 1 & 0 \\ 1 & 0 & 0 & 0 & 0 & 0 \\ 0 & 0 & 1 & 0 & 0 & 0 \end{pmatrix}, \lambda_{pf}(\Gamma_{sts}) = 1, \\
 v_{pf}(\Gamma_{sts}) = (1, 1, 1, 1, 1, 1).$$

$$\sum \text{PFdim } z_i^2 = \text{PFdim } \mathcal{C}$$

Thus, all PF dimensions are 1, and all objects are invertible. Note also that $\text{PFdim}(\text{Vec}_{\mathbb{C}\oplus}^{\omega}(S_3)) = 6 = \text{PFdim}(\text{fdMod}(\mathbb{C}[S_3]))$, the order of S_3 .

8E. **Fusion categories.** Here are the categorical analogs of groups:

Definition 8.31 A semisimple category $\mathcal{C} \in \text{wmFiat}$ is called a **weakly multi fusion category**, and a semisimple category $\mathcal{C} \in \text{wFiat}$ is called a **weakly fusion category**. If these are additionally pivotal, then we call them **multi fusion categories** and **fusion categories**, respectively.

Without further ado we get the full subcategories of the form e.g. $\text{wmFus} \subset \text{wmFiat}$ (again, potentially omitting the w and the m), called e.g. *category of weakly multi fusion categories*, equivalence being $\cong_{\text{S}\oplus\star}$.

Example 8.32 We have already seen the prototypical examples of (weakly) fusion categories, namely $\text{Vec}_{\mathbb{k}\oplus}^{\omega}(G)$ and $\text{fdMod}(\mathbb{k}[G])$, where G is a finite group, in both cases, and $\#G$ does not divide the characteristic of \mathbb{k} in the second case, as well as $\text{fdMod}(A)$ where A is a semisimple Hopf algebra.

Proposition 8.33 Fusion categories can be alternatively defined e.g. as follows:

“A semisimple category $\mathcal{C} \in \text{wmTen}$ is called a **weakly multifusion category**.”

Proof. Clear since semisimple is a stronger notion than abelian, see [Theorem 7.31](#). □

Proposition 8.34 Let $\mathcal{C} \in \text{wmFus}$. Then:

- (i) If $\mathcal{C} \in \text{wFus}$ is \mathbb{k} linear, then $\mathbb{1} \in \text{Si}(\mathcal{C})$.
- (ii) If $\mathcal{C} \in \text{wFus}$, then $X^* \cong {}^*X$ for all $X \in \mathcal{C}$.
- (iii) The fusion coefficients N_{ij}^k are cyclic up to duality, i.e.

$$L_i L_j \cong \bigoplus_{k=1}^n N_{i,j}^k \cdot L_k \Leftrightarrow (L_k^*) L_i \cong \bigoplus_{k=1}^n N_{(k^*),i}^{j^*} \cdot L_j^*$$

- (iv) A regular object is

$$R = \sum_{i=1}^n \text{PFdim}(L_i) \cdot L_i$$

Proof. (i). By $\text{End}_{\mathcal{C}}(\mathbb{1}) \cong \mathbb{k}$, the monoidal unit is indecomposable, hence simple.

(ii). By additivity, it suffices to show $L^* \cong {}^*L$ for all simples. Here we first note that

$$(\text{Hom}_{\mathcal{C}}(\mathbb{1}, L'/L) \neq 0) \Rightarrow (L' \cong L^*), \quad (\text{Hom}_{\mathcal{C}}(L'/L, \mathbb{1}) \neq 0) \Rightarrow (L' \cong {}^*L),$$

by semisimplicity, (i) and Schur's lemma [Lemma 6.68](#). Moreover, also by semisimplicity,

$$\text{Hom}_{\mathcal{C}}(\mathbb{1}, L'L) \cong \text{Hom}_{\mathcal{C}}(L'L, \mathbb{1}),$$

which then in turn implies the claim.

(iii). By noting that

$$N_{ij}^k = \dim(\text{Hom}_{\mathcal{C}}(L_i L_j, L_k)) = \dim(\text{Hom}_{\mathcal{C}}((L_k^*) L_i, L_j^*)) = N_{(k^*),i}^{j^*}$$

which holds by [Theorem 4.16](#) and (ii).

(iv). Using the previous results, we calculate

$$\begin{aligned} L_i R &\cong \bigoplus_{j=1}^n \text{PFdim}(L_j) \cdot L_i L_j \cong \bigoplus_{j,k=1}^n \text{PFdim}(L_j) \cdot N_{i,j}^k L_k \cong \bigoplus_{j,k=1}^n \text{PFdim}(L_j) \cdot N_{(k^*)_i}^{j^*} L_k \\ &\cong \bigoplus_{j,k=1}^n \text{PFdim}(L_j) \cdot N_{(i^*)_k}^j L_k \cong \bigoplus_{k=1}^n \text{PFdim}((L_i^*) L_k) \cdot L_k \\ &\cong \text{PFdim}(L_i^*) \cdot \left(\bigoplus_{k=1}^n \text{PFdim}(L_k) \cdot L_k \right) \cong \text{PFdim}(L_i) \cdot R, \end{aligned}$$

which implies the claim by uniqueness of the regular object. □

Example 8.35 Let G be a finite group, and let $\mathbb{k} = \mathbb{C}$. Note that for any subgroup $H \subset G$ we get an algebra

$$A_H = \bigoplus_{h \in H} \mathfrak{h} \in \mathbf{Vec}_{\mathbb{C} \oplus}(G).$$

These are of course the corresponding group algebras and thus

$$\mathbf{Mod}(A_H) \simeq_{\mathbb{C} \oplus} \mathbf{fdMod}(\mathbb{C}[H]).$$

The generalization of this construction, as explained in details in [\[EGNO15, Example 9.7.2\]](#), takes an algebra $A_H \in \mathbf{Vec}_{\mathbb{C} \oplus}^\omega(G)$ together with a so-called 2-cochain ψ to twist the multiplication of A_H . The corresponding module categories

$$\mathbf{fdMod}_G^{\omega, \psi}(\mathbb{C}[H]) = \mathbf{Mod}(A_H),$$

where $A_H \in \mathbf{Vec}_{\mathbb{C} \oplus}^\omega(G)$ and ψ is a 2-cochain with $d_2 \psi = \omega|_{H \times H \times H}$,

are all fusion categories, and are sometimes called group-like fusion categories.

Remark 8.36 The construction in [Example 8.35](#) can also be done for arbitrary \mathbb{S} instead of \mathbb{C} , by letting the cochains take values in \mathbb{S}^* .

8F. Verlinde categories – part I. There is an important family of fusion categories, which are of paramount importance for the construction of the classical quantum invariants, and also for the theory of fiat and fusion categories. However, they are not easy to construct and we will postpone a more detailed discussion to the later sections. For now we just state the theorem:

Theorem 8.37 For any finite dimensional semisimple complex Lie algebra \mathfrak{g} , any $k \in \mathbb{N}_{>h}$ (where h is the Coxeter number of \mathfrak{g}) and any $q \in \mathbb{C}$ being a primitive $2k$ th root of unity there exists a \mathbb{C} linear category $\mathbf{fdMod}_k^q(\mathfrak{g}) \in \mathbf{Fus}$.

The categories of the form $\mathbf{fdMod}_k^q(\mathfrak{g}) \in \mathbf{Fus}$ are called Verlinde categories.

Proof. We will elaborate later, but the main construction can be found in e.g. [\[An92\]](#). □

Example 8.38 To be at least a bit more explicit, let $\mathfrak{g} = \mathfrak{sl}_2$ where $h = 2$. Let us explain the fusion rules of the categories $\mathbf{fdMod}_k^q(\mathfrak{sl}_2)$ which only depend on k and not on q . So let us fix $k \geq 2$ and choose $q = \exp(\pi i/k)$, for the sake of concreteness. The category $\mathbf{fdMod}_k^q(\mathfrak{sl}_2)$ is ribbon and fusion and has simple objects

$$\text{Si}(\mathbf{fdMod}_k^q(\mathfrak{sl}_2)) = \{L_i \mid i = 0, \dots, k-2\}, \quad L_0 \cong \mathbb{1}, \quad L_i^* \cong L_i.$$

$L_1 \rightsquigarrow$ generator

Handwritten notes:
 Vec(G)
 fdMod(G)
 Ver
 ← level
 sl₂
 sl₂
 sl₂
 sl₂

The fusion rules are given by the **truncated Clebsch–Gordan rule**

$$(8-5) \quad L_i L_j \cong \bigoplus_{l=\max(i+j-k+2,0)}^{\min(i,j)} L_{i+j-2l}$$

Let us discuss a few cases for small k :

- For $k = 2$ we have $\mathbf{fdMod}_2^q(\mathfrak{sl}_2) \cong \mathbf{Vec}_{\mathbb{C}}$. Hence, the fusion generator $\mathbb{1}$ has $\mathbf{PFdim}(\mathbb{1}) = 2 \cos(\pi/2) = 1$ giving $\mathbf{PFdim}(\mathbf{fdMod}_2^q(\mathfrak{sl}_2)) = 1$.
- For $k = 3$ we have that the fusion generator L_1 satisfies

$$\mathbb{1} = L_0 \quad L_1 L_1 \cong \mathbb{1}, \quad \Gamma_1 = \begin{pmatrix} 0 & 1 \\ 1 & 0 \end{pmatrix} = \mathbb{1} \longleftrightarrow L_1, \quad \mathbf{PFdim}(\Gamma_1) = 2 \cos(\pi/3).$$

And thus, $\mathbf{PFdim}(\mathbf{fdMod}_3^q(\mathfrak{sl}_3)) = 2$. One can actually show that $\mathbf{fdMod}_k^q(\mathfrak{sl}_2) \simeq_{\mathbb{C} \oplus \star} \mathbf{Vec}_{\mathbb{C} \oplus (\mathbb{Z}/2\mathbb{Z})}$.

- For $k = 4$ the fusion rules take the form

\otimes	L_1	L_2
L_1	$\mathbb{1} \oplus L_2$	L_1
L_2	L_1	$\mathbb{1}$

Thus, we get the fusion graphs

$$\Gamma_1 = \begin{pmatrix} 0 & 1 & 0 \\ 1 & 0 & 1 \\ 0 & 1 & 0 \end{pmatrix} = \mathbb{1} \longleftrightarrow L_1 \longleftrightarrow L_2, \quad \mathbf{PFdim}(\Gamma_1) = 2 \cos(\pi/4),$$

$$\Gamma_2 = \begin{pmatrix} 0 & 0 & 1 \\ 0 & 1 & 0 \\ 1 & 0 & 0 \end{pmatrix} = \mathbb{1} \begin{matrix} \longleftarrow \\ \uparrow \\ \longrightarrow \end{matrix} L_1 \begin{matrix} \longleftarrow \\ \uparrow \\ \longrightarrow \end{matrix} L_2, \quad \mathbf{PFdim}(\Gamma_2) = 1.$$

Hence, $\mathbf{PFdim}(\mathbf{fdMod}_4^q(\mathfrak{sl}_2)) = 2 + 2 \cos(\pi/4)^2$.

For general $k \geq 2$ the object L_1 will be a fusion generator of $\mathbf{fdMod}_k^q(\mathfrak{sl}_2)$ linear fusion graph

$$\Gamma_1 = \mathbb{1} \longleftrightarrow L_1 \longleftrightarrow L_2 \longleftrightarrow \dots \longleftrightarrow L_k,$$

and $\mathbf{PFdim}(L_1) = 2 \cos(\pi/k)$.

Example 8.39 Using the same notion as in Example 8.38, note that there is a full subcategory $\mathbf{fdMod}_k^q(\mathfrak{so}_3) \subset \mathbf{fdMod}_k^q(\mathfrak{sl}_2)$ with

$$(\mathbf{fdMod}_k^q(\mathfrak{so}_3)) = \{L_i \mid i = 0, \dots, k-2, i \text{ even}\}, \quad L_0 \cong \mathbb{1}, \quad L_i^* \cong L_i,$$

and exactly the same fusion rules, i.e. (8-5), just taking even indexes only. Again, let us discuss some cases in detail:

- The cases $k = 2$ and $k = 3$ will now collide and are as in Example 8.38.
- The case $k = 4$ gives $\mathbf{fdMod}_k^q(\mathfrak{so}_3) \cong \mathbf{Vec}_{\mathbb{C} \oplus (\mathbb{Z}/2\mathbb{Z})}$.
- For $k = 5$ one can show that $\mathbf{fdMod}_k^q(\mathfrak{so}_3) \cong \mathbf{Fib}$ (the Fibonacci category, see Example 8.26) for $q = \exp(\pi i/5)$.

$$\bullet \longleftrightarrow \bullet \quad \phi = \mathbb{1}F$$

- For $k = 6$ the fusion rules take the form

\otimes	L_2	L_4
L_2	$\mathbb{1} \oplus L_2 \oplus L_4$	L_2
L_4	L_2	$\mathbb{1}$

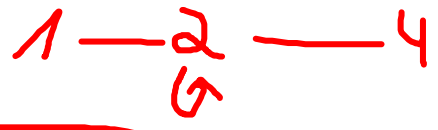

and we get the fusion graphs

$$\Gamma_2 = \begin{pmatrix} 0 & 1 & 0 \\ 1 & 1 & 1 \\ 0 & 1 & 0 \end{pmatrix} = \mathbb{1} \begin{matrix} \longleftarrow \\ \longleftarrow \\ \longleftarrow \end{matrix} L_2 \begin{matrix} \longrightarrow \\ \longrightarrow \\ \longrightarrow \end{matrix} L_4, \quad \text{PFdim}(\Gamma_2) = 2$$

$$\Gamma_4 = \begin{pmatrix} 0 & 0 & 1 \\ 0 & 1 & 0 \\ 1 & 0 & 0 \end{pmatrix} = \mathbb{1} \begin{matrix} \longleftarrow \\ \longleftarrow \\ \longleftarrow \end{matrix} L_2 \begin{matrix} \longrightarrow \\ \longrightarrow \\ \longrightarrow \end{matrix} L_4, \quad \text{PFdim}(\Gamma_1) = 1.$$

Hence, $\text{PFdim}(\text{fdMod}_6^q(\mathfrak{so}_3)) = 6$. In fact, $\text{fdMod}_6^q(\mathfrak{so}_3) \simeq_{\mathbb{C} \oplus \star} \text{fdMod}(\mathbb{C}[S_3])$.

- Finally, for $k = 7$ we get

\otimes	L_2	L_4
L_2	$\mathbb{1} \oplus L_2 \oplus L_4$	$L_2 \oplus L_4$
L_4	$L_2 \oplus L_4$	$\mathbb{1} \oplus L_2$

← fix

Thus, the fusion graphs are

$$\Gamma_2 = \begin{pmatrix} 0 & 1 & 0 \\ 1 & 1 & 1 \\ 0 & 1 & 1 \end{pmatrix} = \mathbb{1} \begin{matrix} \longleftarrow \\ \longleftarrow \\ \longleftarrow \end{matrix} L_2 \begin{matrix} \longrightarrow \\ \longrightarrow \\ \longrightarrow \end{matrix} L_4, \quad \text{PFdim}(\Gamma_2) = 2,$$

$$\Gamma_4 = \begin{pmatrix} 0 & 0 & 1 \\ 0 & 1 & 1 \\ 1 & 1 & 0 \end{pmatrix} = \mathbb{1} \begin{matrix} \longleftarrow \\ \longleftarrow \\ \longleftarrow \end{matrix} L_2 \begin{matrix} \longrightarrow \\ \longrightarrow \\ \longrightarrow \end{matrix} L_4, \quad \text{PFdim}(\Gamma_1) = 1.$$

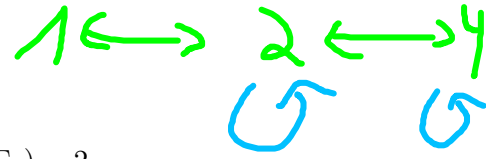

For general $k = 2l \geq 4$ or $k = 2l + 1 \geq 5$ the object L_2 will be a fusion generator of $\text{fdMod}_k^q(\mathfrak{so}_3)$ with fusion graph

$$\Gamma_2 = \mathbb{1} \begin{matrix} \longleftarrow \\ \longleftarrow \\ \longleftarrow \end{matrix} L_2 \begin{matrix} \longrightarrow \\ \longrightarrow \\ \longrightarrow \end{matrix} L_4 \begin{matrix} \longleftarrow \\ \longleftarrow \\ \longleftarrow \end{matrix} \dots \begin{matrix} \longrightarrow \\ \longrightarrow \\ \longrightarrow \end{matrix} L_{2l-2} \begin{matrix} \longrightarrow \\ \longrightarrow \\ \longrightarrow \end{matrix} L_l \quad \text{if } k = 2l \geq 4,$$

$$\Gamma_2 = \mathbb{1} \begin{matrix} \longleftarrow \\ \longleftarrow \\ \longleftarrow \end{matrix} L_2 \begin{matrix} \longrightarrow \\ \longrightarrow \\ \longrightarrow \end{matrix} L_4 \begin{matrix} \longleftarrow \\ \longleftarrow \\ \longleftarrow \end{matrix} \dots \begin{matrix} \longrightarrow \\ \longrightarrow \\ \longrightarrow \end{matrix} L_{2l-2} \begin{matrix} \longrightarrow \\ \longrightarrow \\ \longrightarrow \end{matrix} L_l \quad \text{if } k = 2l + 1 \geq 5.$$

There is almost no redundancy:

Proposition 8.40 We have

$$\left(\text{fdMod}_k^q(\mathfrak{sl}_2) \simeq_{\mathbb{C} \oplus \star} \text{fdMod}_{k'}^{q'}(\mathfrak{sl}_2) \right) \Leftrightarrow (k = k' \text{ and } (q = q' \text{ or } q^{-1} = q')),$$

$$\left(\text{fdMod}_k^q(\mathfrak{so}_3) \simeq_{\mathbb{C} \oplus \star} \text{fdMod}_{k'}^{q'}(\mathfrak{so}_3) \right) \Leftrightarrow (k = k' \text{ and } (q = q' \text{ or } q^{-1} = q')).$$

Proof. See [FK93, Proposition 8.2.3].

□

Example 8.41 Note that the $k = 5$ case in [Example 8.39](#) has now two non-equivalent cases: $\text{fdMod}_k^q(\mathfrak{so}_3) \cong \mathbf{Fib}$, which happens for $q = \exp(\pi i/5)$, and another fusion category appearing for $q = \exp(2\pi i/5)$.

8G. Classifying fiat, tensor and fusion categories. Let us now address some classification problems. Namely, we want to ask (in order) whether one can classify fiat, tensor or fusion categories with a given $K_0^\oplus(-)$, with a fixed rank $\text{rk}(-)$ or a fixed PF dimension $\text{PFdim}(-)$.

Remark 8.42 We will be a bit sketchy in this section because we want to state theorems which are easy to understand (and worthwhile to be stated) but sometimes not easy to prove.

The arguable most important theorem in the theory is Ocneanu rigidity, which is a “uniqueness of categorifications” type of statement:

Theorem 8.43 The number of \mathbb{k} linear weakly multi fusion categories (up to $\simeq_{\mathbb{k} \oplus \star}$ equivalence) with a given $K_0^\oplus(-)$ is finite. *← Clas. is possible*

Proof. The (not easy) proof of this theorem can be found in e.g. [EGNO15, Theorem 9.1.4]. \square

We have already seen two numerical invariants, which only depend only on $K_0^\oplus(-)$, of fiat categories: the rank, cf. [Proposition 7.51](#) and the PF dimension, cf. [Definition 8.25](#), and both discrete valued and ≥ 1 . Thus, [Theorem 8.43](#) motivates the question whether one can classify fiat or fusion categories of a given $K_0^\oplus(-)$, of a given rank or of a given PF dimension.

Let us start by fixing $K_0^\oplus(-)$.

→ Groups \rightsquigarrow Groups

Proposition 8.44 Let G be a finite group. If $\mathbf{C} \in \mathbf{wmFus}$ is \mathbb{C} linear and has $K_0^\oplus(\mathbf{C}) \cong \mathbb{Z}[G]$ as \mathbb{Z} algebras, then $\mathbf{C} \simeq_{\mathbb{C} \oplus \star} \mathbf{Vec}_{\mathbb{C} \oplus}^\oplus(G)$.

Proof. By carefully writing down all equations coming from the associativity and unitality constrains, see e.g. [EGNO15, Proposition 4.10.3] for details. \square

For a finite group G let TY_G denote the so-called Tambara–Yamagami fusion ring given by adjoining a self-dual element X to $\mathbb{Z}[G]$ satisfying the fusion rules

$$gX = Xg = X, \quad X^2 = \sum_{g \in G} g.$$

(Here we use the terminology from above for the \mathbb{Z} algebra $K_0^\oplus(-)$ itself.)

Example 8.45 For $G = \mathbb{Z}/3\mathbb{Z}$ the fusion rules etc. of $\text{TY}_{\mathbb{Z}/3\mathbb{Z}}$ are

\otimes		1	2	X
1		2	0	X
2		0	1	X
X		X	X	$0 + 1 + 2$

$$\Gamma_X = \begin{pmatrix} 0 & 0 & 0 & 1 \\ 0 & 0 & 0 & 1 \\ 0 & 0 & 0 & 1 \\ 1 & 1 & 1 & 0 \end{pmatrix} = \begin{array}{c} \text{1} \\ \updownarrow \\ 0 \longleftrightarrow X \longleftrightarrow 2 \end{array}, \quad \text{PFdim}(X) = \sqrt{3}.$$

For general G we have

$$\text{PFdim}(g) = 1, \quad \text{PFdim}(X) = \sqrt{\#G}, \quad \text{PFdim}(\text{TY}_G) = 2\#G.$$

Proposition 8.46 *Let G be a finite group. If $\mathbf{C} \in \mathbf{wmFus}$ is \mathbb{C} linear and has $K_0^\oplus(\mathbf{C}) \cong \mathrm{TY}_G$ as \mathbb{Z} algebras, then G is abelian. Moreover, for any abelian G there exists a $\mathbf{C} \in \mathbf{wmFus}$ with $K_0^\oplus(\mathbf{C}) \cong \mathrm{TY}_G$ as \mathbb{Z} algebras, and such weakly multi fusion categories are parameterized (up to $\simeq_{\mathbb{C} \oplus \star}$ equivalence) by symmetric isomorphisms $G \xrightarrow{\cong} G^\vee$ and a choice of sign.*

Proof. This is the main result of [TY98]. □

Let us continue by fixing the rank:

Proposition 8.47 *We have the following.*

(i) *If $\mathbf{C} \in \mathbf{wmFiat}$ is \mathbb{k} linear of $\mathrm{rk}(\mathbf{C}) = 1$, then $\mathbf{C} \simeq_{\mathbb{k} \oplus \star} \mathbf{fdVec}_{\mathbb{k}}$.*

(ii) *If $\mathbf{D} \in \mathbf{wTen}$ is \mathbb{k} linear of $\mathrm{rk}(\mathbf{D}) = 1$ and \mathbb{k} is of characteristic zero, then $\mathbf{D} \simeq_{\mathbb{k} \epsilon \star} \mathbf{fdVec}_{\mathbb{k}}$.*

Proof. (i). Note that any object $X \in \mathbf{C}$ is a direct sum of the unique indecomposable Z , i.e. there exists a $k \in \mathbb{N}$ such that $X \cong k \cdot Z$. Hence, we have clearly

$$(m \leq k, l) \Leftrightarrow \begin{array}{ccc} & k \cdot Z & \\ & \swarrow \exists! \quad \downarrow p & \\ & u & \\ l \cdot Z & \dashrightarrow f & m \cdot Z \end{array},$$

showing that X is projective. Hence, we are done by e.g. Theorem 7.36 since \mathbf{C} has to be semisimple.

$\mathbb{1} = k \cdot Z$ for some $k \in \mathbb{N}_{>0}$, which implies that $\mathbb{1}$ is projective.

(ii). Recall that in each abelian category one can define the abelian group of extensions $\mathrm{Ext}_{\mathbf{C}}^1(X, Y)$ to be the equivalence class (for an appropriate equivalence) of SES of the form

$$X \xrightarrow{i} E \xrightarrow{p} Y$$

The SES of this form which split, i.e. where $E \cong X \oplus Y$, are trivial in $\mathrm{Ext}_{\mathbf{C}}^1(X, Y)$.

Back to $\mathbf{D} \in \mathbf{wTen}$, we claim that $\mathrm{Ext}_{\mathbf{D}}^1(\mathbb{1}, \mathbb{1}) = 0$.

To this end, suppose the converse. We want to show that $\mathrm{End}_{\mathbf{D}}(\mathbb{P}_{\mathbb{1}})$ has under this assumption infinitely many modules of dimension one, which is a contradiction since $\mathrm{End}_{\mathbf{D}}(\mathbb{P}_{\mathbb{1}})$ is a finite dimensional \mathbb{k} algebra. Let E be a non-trivial extension of $\mathbb{1}$ by itself. Then $\mathrm{Hom}_{\mathbf{D}}(\mathbb{P}_{\mathbb{1}}, E)$ is of dimension two, has a filtration of length 2 with quotients isomorphic to $\mathrm{Hom}_{\mathbf{D}}(\mathbb{P}_{\mathbb{1}}, \mathbb{1})$. Note that $\mathrm{End}_{\mathbf{D}}(\mathbb{P}_{\mathbb{1}})$ acts on both, $\mathrm{Hom}_{\mathbf{D}}(\mathbb{P}_{\mathbb{1}}, E)$ and $\mathrm{Hom}_{\mathbf{D}}(\mathbb{P}_{\mathbb{1}}, \mathbb{1})$, from the right. Thus, taking all of this together and letting $d_0: \mathrm{End}_{\mathbf{D}}(\mathbb{P}_{\mathbb{1}}) \rightarrow \mathbb{k}$ denote the character obtained from the right action on $\mathrm{Hom}_{\mathbf{D}}(\mathbb{P}_{\mathbb{1}}, \mathbb{1})$, we can find a basis of $\mathrm{Hom}_{\mathbf{D}}(\mathbb{P}_{\mathbb{1}}, E)$ such that the action matrices of $\mathrm{End}_{\mathbf{D}}(\mathbb{P}_{\mathbb{1}})$ take the form

$$M_a = \begin{pmatrix} d_0(a) & d_1(a) \\ 0 & d_0(a) \end{pmatrix}, \begin{pmatrix} d_0(ab) & d_1(ab) \\ 0 & d_0(ab) \end{pmatrix} = M_{ab} = M_a M_b = \begin{pmatrix} d_0(ab) & d_0(a)d_1(b) + d_1(a)d_0(b) \\ 0 & d_0(ab) \end{pmatrix},$$

where $d_1(a) \neq 0$, satisfying $d_1(ab) = d_0(a)d_1(b) + d_1(a)d_0(b)$, as indicated. Similarly, for any $k \in \mathbb{N}_{>0}$, we get a 2^k dimensional $\mathrm{End}_{\mathbf{D}}(\mathbb{P}_{\mathbb{1}})$ module $\mathrm{Hom}_{\mathbf{D}}(\mathbb{P}_{\mathbb{1}}, E^k)$, and one can show that the corresponding $d_k(-)$ satisfies a recursive equality of the form

$$d_k(ab) = \sum_{i=0}^k \binom{k}{i} d_i(a) d_{k-i}(b).$$

This implies that we can define infinitely many distinct one dimensional $\text{End}_{\mathbf{D}}(\mathbb{P}_{\mathbb{1}})$ modules by the formula

$$e_x(a) = \sum_{i=0}^{\infty} \frac{1}{i!} \cdot d_i(a)x^i t^i \in \mathbb{k}((t)).$$

(Here we use that \mathbb{k} is of characteristic zero because we need $\frac{1}{i!}$, and this formally speaking ends in $\mathbb{k}((t))$.) A contradiction, and we get $\text{Ext}_{\mathbf{D}}^1(\mathbb{1}, \mathbb{1}) = 0$.

Finally, $\text{Ext}_{\mathbf{D}}^1(\mathbb{1}, \mathbb{1}) = 0$ implies that \mathbf{D} is semisimple, and the claim follows. \square

Example 8.48 Note the difference between [Proposition 8.47](#).(i) and (ii): The first assumes the number of indecomposables to be one, the other assumes the number of simples to be one. In fact, as we have seen in [Example 6.91](#), there are examples of tensor categories with one simple objects which are not equivalent to $\mathbf{fdVec}_{\mathbb{k}}$.

Let us try to go to rank 2:

Proposition 8.49 Let $\mathbf{C} \in \mathbf{wmFus}$ be \mathbb{C} linear of rank $\text{rk}(\mathbf{C}) = 2$. Then \mathbf{C} is equivalent (as a fusion category) to one of the following cases.

- $\mathbf{C} \simeq_{\mathbb{C}\oplus\star} (\mathbf{Vec}_{\mathbb{C}} \oplus \mathbf{Vec}_{\mathbb{C}})$.
 - $\mathbf{C} \simeq_{\mathbb{k}\oplus\star} \mathbf{Vec}_{\mathbb{C}\oplus}(\mathbb{Z}/2\mathbb{Z})$.
 - $\mathbf{C} \simeq_{\mathbb{C}\oplus\star} \mathbf{Vec}_{\mathbb{C}\oplus}^{\omega}(\mathbb{Z}/2\mathbb{Z})$ for the non-trivial $\omega \in H^3(\mathbb{Z}/2\mathbb{Z}, \mathbb{C}^*) \cong \mathbb{Z}/2\mathbb{Z}$.
 - $\mathbf{C} \simeq_{\mathbb{C}\oplus\star} \mathbf{fdMod}_5^q(\mathfrak{sl}_2)$ for $q = \exp(\pi i/5)$.
 - $\mathbf{C} \simeq_{\mathbb{C}\oplus\star} \mathbf{fdMod}_5^q(\mathfrak{sl}_2)$ for $q = \exp(2\pi i/5)$.
- Verlinkte*

Proof. Let us sketch the proof, and a general proof strategy, details can be found in [\[Os03\]](#).

We start by observing that, if \mathbf{C} is not transitive, then each simple spans a copy of $\mathbf{Vec}_{\mathbb{C}}$ and we are in the first case. Similarly if $\mathbb{1}$ is not simple.

Thus, we can assume that \mathbf{C} is transitive and $\mathbb{1} \in \text{Si}(\mathbf{C})$. In this case we have another self-dual simple object L and the fusion rules

$$(8-6) \quad L^2 \cong m \cdot \mathbb{1} \oplus n \cdot L.$$

First, the coefficient m of $\mathbb{1}$ has to be one, by rigidity. The main work is now to show that there is no fusion category \mathbf{C} for which $n > 2$ in (8-6). This is non-trivial and needs some clever arguments, and is the main point of [\[Os03\]](#):

$$(8-7) \quad \text{There is no fusion category with fusion rules as in (8-6) for } m \neq 1 \text{ and } n > 2.$$

So let us assume that $n = 0$ and $n = 1$ are the only possible solutions. In both cases we already know solutions, namely the above listed cases 2 and 3 for $n = 0$, where $K_0(\mathbf{C}) \cong \mathbb{Z}[\mathbb{Z}/2\mathbb{Z}]$, respectively 4 and 5 for $n = 1$. A careful study of the associativity constrains (as we already did for $K_0(\mathbf{C}) \cong \mathbb{Z}[\mathbb{Z}/2\mathbb{Z}]$ throughout the previous sections) shows that there can not be other solutions. \square

Note that the proof of [Proposition 8.49](#) had three main features which are part of a general strategy to classify fiat and fusion categories, in increasing difficulty:

- write down the possible solutions on the Grothendieck level, which was (8-6) above;
- use the categorical properties of \mathbf{C} to rule out cases, which was (8-7) above;
- in the remaining cases construct the categories and analyze the various categorical constrains to show that one has found all solutions, which was the last step above.

Example 8.50 To rule out the cases $n > 2$ in (8-6) requires all assumptions. For example, if one drops the assumption on \mathbf{C} to be semisimple, then $m = 0$ and n arbitrary can indeed occur. We have already seen an example, namely $\mathbf{fdProj}(\overline{\mathbb{F}}_p(\mathbb{Z}/p\mathbb{Z}))$, see e.g. (7-14), where $P_1 P_1 \cong p \cdot P_1$. (Formally speaking, we would need to adjoin the monoidal unit to $\mathbf{fdProj}(\overline{\mathbb{F}}_p(\mathbb{Z}/p\mathbb{Z}))$ to make this example solid.)

To continue to try to classify fusion categories by their ranks get tricky, and is doomed to fail from some point on. Let us state the $\text{rk}(\mathbf{C}) = 3$ result, ordered as in the strategy list above:

Proposition 8.51 Let $\mathbf{C} \in \mathbf{Fus}$ be \mathbb{C} linear of rank $\text{rk}(\mathbf{C}) = 3$. Let $\mathbf{Si}(\mathbf{C}) = \{L_1 = \mathbb{1}, L_2, L_3\}$. Then:

- The only possible fusion rules of \mathbf{C} are:

\otimes	L_2	L_3
L_2	L_3	$\mathbb{1}$
L_3	$\mathbb{1}$	L_2

\otimes	L_2	L_3
L_2	$\mathbb{1} \oplus m \cdot L_2 \oplus k \cdot L_3$	$k \cdot L_2 \oplus l \cdot L_3$
L_3	$k \cdot L_2 \oplus l \cdot L_3$	$\mathbb{1} \oplus l \cdot L_2 \oplus n \cdot L_3$

where $k, l, m, n \in \mathbb{N}$ satisfying $k^2 + l^2 = kn + lm + 1$.

- Only the following cases can occur:

(A):	$\begin{array}{c c c} \otimes & L_2 & L_3 \\ \hline L_2 & L_3 & \mathbb{1} \\ \hline L_3 & \mathbb{1} & L_2 \end{array}$	(B):	$\begin{array}{c c c} \otimes & L_2 & L_3 \\ \hline L_2 & \mathbb{1} \oplus L_2 \oplus L_3 & L_2 \oplus L_3 \\ \hline L_3 & L_2 \oplus L_3 & \mathbb{1} \oplus L_2 \end{array}$	(C):	$\begin{array}{c c c} \otimes & L_2 & L_3 \\ \hline L_2 & \mathbb{1} \oplus L_3 & L_2 \\ \hline L_3 & L_2 & \mathbb{1} \end{array}$
(D):	$\begin{array}{c c c} \otimes & L_2 & L_3 \\ \hline L_2 & \mathbb{1} \oplus L_2 \oplus L_3 & L_2 \\ \hline L_3 & L_2 & \mathbb{1} \end{array}$	(E):	$\begin{array}{c c c} \otimes & L_2 & L_3 \\ \hline L_2 & \mathbb{1} \oplus 2 \cdot L_2 \oplus L_3 & L_2 \\ \hline L_3 & L_2 & \mathbb{1} \end{array}$		

easy

- For (A) we have the solutions $\mathbf{Vec}_{\mathbb{C}^\oplus}^\omega(\mathbb{Z}/3\mathbb{Z})$ (note that $H^3(\mathbb{Z}/3\mathbb{Z}, \mathbb{C}^*) \cong \mathbb{Z}/3\mathbb{Z}$).
- For (B) we have the solutions $\mathbf{fdMod}_7^q(\mathfrak{so}_3)$. *Verlinde*
- For (C) we have the solutions $\mathbf{fdMod}_4^q(\mathfrak{sl}_2)$. *5*
- For (D) we have the solutions $\mathbf{fdMod}(S_3)$ and twists (as in Example 8.35).
- For (E) we have two solutions, a fusion category associated with a subfactor of type E_6 or its Galois conjugate. (See e.g. [HH09] for the definitions.) *Exotic hard to construct*
- There are no other solutions.

Proof. This is proven in [Os13].

Exotic hard to construct

□

Let us have a look now at the PF dimension.

Theorem 8.52 Let $F \in \mathbf{Hom}_{\mathbb{k} \oplus \star}(\mathbf{C}, \mathbf{D})$, where $\mathbf{C}, \mathbf{D} \in \mathbf{wFiat}$ are \mathbb{k} linear. Then:

(i) If F is fully faithful, then

$$\text{PFdim}(\mathbf{C}) \leq \text{PFdim}(\mathbf{D}),$$

with equality achieved if and only if F is an equivalence.

(ii) If F is fully faithful, then

$$\text{PFdim}(\mathbf{C}) \geq \text{PFdim}(\mathbf{D}),$$

with equality achieved if and only if F is an equivalence.

Proof. This can be proven *mutatis mutandis* as in [EGNO15, Propositions 6.3.3 and 6.3.4]. \square

Proposition 8.53 If $\mathbf{C} \in \mathbf{wFiat}$ is \mathbb{k} linear of PF dimension $\text{PFdim}(\mathbf{C}) = 1$, then $\mathbf{C} \simeq_{\mathbb{k} \oplus \star} \mathbf{fdVec}_{\mathbb{k}}$.

Proof. We already know that $\text{PFdim}(\mathbf{C}) \geq 1$, see Proposition 8.28. Moreover, there is always a fully faithful functor $F: \mathbf{fdVec}_{\mathbb{k}} \rightarrow \mathbf{C}$ given by $\mathbb{k} = \mathbb{1} \mapsto \mathbb{1}$. Thus, the claim follows from Theorem 8.52.(i). \square

The analog of “All finite groups of prime order are cyclic.” is:

Proposition 8.54 If $\mathbf{C} \in \mathbf{wFiat}$ is \mathbb{C} linear and satisfies $\text{PFdim}(\mathbf{C}) = p$ for $p \in \mathbb{N}$ being a prime, then $\mathbf{C} \simeq_{\mathbb{k} \oplus \star} \mathbf{Vec}_{\mathbb{C} \oplus}^{\omega}(\mathbb{Z}/p\mathbb{Z})$.

↑ Cool!

Proof. See [ENO05, Corollary 8.30]. \square

An extraordinary fact is that PF dimensions are quantized:

Proposition 8.55 Let $\mathbf{C} \in \mathbf{wFus}$ be \mathbb{k} linear, and let $L_1 \in \text{Si}(\mathbf{C})$ be a fusion generator of PF dimension $\text{PFdim}(L_1) < 2$. Then:

(i) $\text{PFdim}(L_1) = 2 \cos(\pi/k)$ for some k .

↑ $1 \leq \dots < 2$
 $2 \cos(\pi/k)$

(ii) The fusion graph of L_1 is one of the following ADE types:

Type A: $\mathbb{1} \rightleftarrows L_1 \rightleftarrows L_2 \rightleftarrows \dots \rightleftarrows L_k$,

Type D: $\mathbb{1} \rightleftarrows L_1 \rightleftarrows L_2 \rightleftarrows \dots \rightleftarrows L_k$,

(8-8)

Type E_6 :

$$\begin{array}{ccccccc} & & & L_5 & & & \\ & & & \updownarrow & & & \\ \mathbb{1} & \rightleftarrows & L_1 & \rightleftarrows & L_2 & \rightleftarrows & L_3 & \rightleftarrows & L_5 \end{array}$$

Type E_7 :

$$\begin{array}{ccccccc} & & & L_6 & & & \\ & & & \updownarrow & & & \\ \mathbb{1} & \rightleftarrows & L_1 & \rightleftarrows & L_2 & \rightleftarrows & L_3 & \rightleftarrows & L_4 & \rightleftarrows & L_5 \end{array}$$

Type E_8 :

$$\begin{array}{ccccccc} & & & L_7 & & & \\ & & & \updownarrow & & & \\ \mathbb{1} & \rightleftarrows & L_1 & \rightleftarrows & L_2 & \rightleftarrows & L_3 & \rightleftarrows & L_4 & \rightleftarrows & L_5 & \rightleftarrows & L_6 \end{array}$$

Verlinde

"Verlink"

(iii) For all the graphs in (8-8) there exists a fusion category with a fusion generator having the corresponding fusion graph.

(iv) In type A the fusion category is of the form $\mathbf{fdMod}_k^q(\mathfrak{sl}_2)$.

Proof. See e.g. [FK93, Chapter 8]. □

8H. **A pseudo classification – or, summarizing the above.** Let G be a finite group and let us call $\mathbf{Vec}_{\mathbb{C}^\oplus}^\omega(G)$ for non-trivial ω a *twist* of $\mathbf{Vec}_{\mathbb{C}^\oplus}(G)$. Similarly, we have *twists* of $\mathbf{fdMod}(G)$, cf. Example 8.35, and we also call the Verlinde categories $\mathbf{fdMod}_k^q(\mathfrak{g})$ for $q \neq \exp(\pm\pi i/k)$ *twists* of the standard choice $q = \exp(\pi i/k)$. Then we have the following pseudo classification, motivated by the above.

“Theorem” 8.56 All \mathbb{C} linear fusion categories are one of the following types:

(I) Categories of the form $\mathbf{Vec}_{\mathbb{C}^\oplus}(G)$ and twists.

(II) Categories of the form $\mathbf{fdMod}(G)$ and twists.

(III) Categories of the form $\mathbf{fdMod}_k^q(\mathfrak{g})$ and twists.

(IV) Exceptions.

Verlinde
Exotic

The crucial point, which we will explore in the following sections, will be: □

The main source of quantum invariants are the fusion categories of type (III).

The fusion categories of types (I), (II) and (IV) sometimes also give quantum invariants. But it turns out that types (I) and (II) give rather “boring” invariants, while type (IV) remains to be explored further.

8I. Exercises.

Exercise 8.57 Try to understand the claims in [Example 8.5](#) and verify as many of them as possible.

Exercise 8.58 Calculate the fusion graphs and PF dimensions of $\text{fdMod}(\overline{\mathbb{F}}_5[\mathbb{Z}/5\mathbb{Z}])$ and of $\text{fdMod}(\mathbb{C}[S_5])$. The latter is a semisimple fiat category and has the fusion rules $L_1 \cong \mathbb{1}$ and

\otimes	L_s	L_b	$L_{s'}$	$L_{1'}$
L_s	$\mathbb{1} \oplus L_s \oplus L_b \oplus L_{s'}$	$L_s \oplus L_{s'}$	$L_s \oplus L_b \oplus L_{s'} \oplus L_{1'}$	$L_{s'}$
L_b	$L_s \oplus L_{s'}$	$\mathbb{1} \oplus L_b \oplus L_{1'}$	$L_s \oplus L_{s'}$	L_b
$L_{s'}$	$L_s \oplus L_b \oplus L_{s'} \oplus L_{1'}$	$L_s \oplus L_{s'}$	$\mathbb{1} \oplus L_s \oplus L_b \oplus L_{s'}$	L_s
$L_{1'}$	$L_{s'}$	L_b	L_s	$\mathbb{1}$

Exercise 8.59 Complete the discussion in [Example 8.29](#).

Exercise 8.60 Verify the calculations in [Example 8.45](#).

Exercise 8.61 Prove the last claim in [Example 8.38](#) and [Example 8.39](#).

9. FUSION AND MODULAR CATEGORIES – DEFINITIONS AND GRAPHICAL CALCULUS

The question we want to address is:

Can we separate “topologically boring” fiat categories from “topologically interesting” ones?

The answer will turn out to be “Yes and no.”

9A. **A word about conventions.** Of course, we keep the previous conventions.

Convention 9.1 We will revised several properties which we have seen before and which depend on choices such as being braided. As before we tend to write e.g. “ABC is XYZ” instead of the formally correct “there is a choice such that ABC is XYZ” etc.

9B. **Hom spaces in fiat, tensor and fusion categories.** Let us start by motivating the diagrammatics which we will see below.

If $\mathbf{C} \in \text{Cat}_{\mathbb{K}S}$ and $\text{Si}(\mathbf{C}) = \{L_1, \dots, L_m\}$, then Schur’s lemma [Lemma 6.69](#) allows us to compute hom spaces as follows. Let $X, Y \in \mathbf{C}$, and decompose them into simples

semisimple $X \cong \bigoplus_{i=1}^m [X : L_i] \cdot L_i, \quad Y \cong \bigoplus_{i=1}^m [Y : L_i] \cdot L_i.$

Then we have the decomposition and dimension formulas

(9-1) $\text{Hom}_{\mathbf{C}}(X, Y) \cong \bigoplus_{i=1}^m \text{Mat}_{[X:L_i] \times [Y:L_i]}(\mathbb{K}), \quad \dim(\text{Hom}_{\mathbf{C}}(X, Y)) = \sum_{i=1}^m [X : L_i][Y : L_i].$

g is iso if $L_i = L_j$ | $g = 0$ $L_i \neq L_j$

*L_i
 \uparrow
 g
 \uparrow
 L_i*

Example 9.2 Assume that $X \cong 2L_1 \oplus L_2$ and $Y \cong L_1 \oplus L_3$. Then

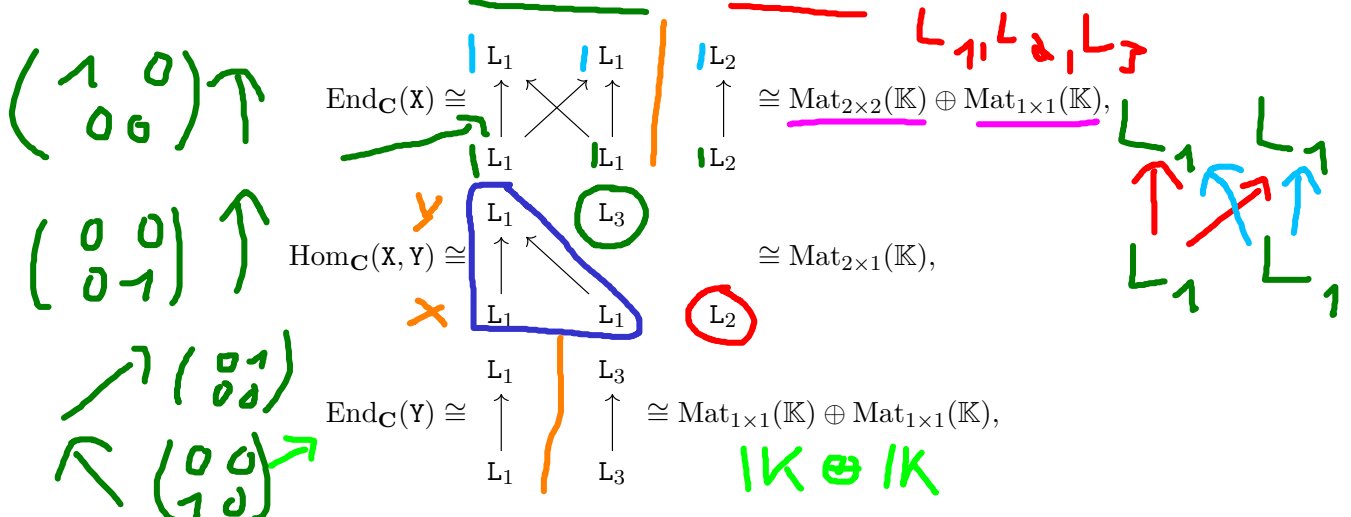

illustrates the validity of the formulas in (9-1), where each arrow represents a, up to scalars unique, basis element of the hom spaces. An object such as Y is also called multiplicity free, referring to the decomposition of Y having each simple appear at most once.

Note that (9-1) fails in the non-semisimple case: For $C \in \mathbf{Cat}_{\mathbb{K} \oplus \mathbb{K}}$, $\text{Si}(C) = \{L_1, \dots, L_m\}$, and $\text{In}(C) = \{Z_1, \dots, Z_n\}$, Schur's lemma does not hold between indecomposables and hom spaces need not to be matrix \mathbb{K} algebras, but rather matrix algebras over some local \mathbb{K} algebra.

Example 9.3 Back to Example 6.91: In $\mathbf{fdMod}(\mathbb{F}_5[\mathbb{Z}/5\mathbb{Z}])$ we have seen that $\mathbb{1} = Z_1$ and its projective cover $P_{\mathbb{1}} = Z_5$ are non-isomorphic indecomposables. However, by the definition of the projective cover, the hom space between them is non-zero.

However, we still have the idempotent decomposition of id_X , i.e.

$$(9-2) \quad \text{id}_X = \sum_{i=1}^n \sum_{j=1}^{(X:Z_i)} i_{i,j} p_{i,j}, \quad p_{i_k} i_{j_l} = \delta_{i,j} \delta_{k,l} \text{id}_{Z_{i_k}},$$

$i_{i,j} : Z_{i_j} \hookrightarrow X$ j th inclusion, $p_{i,j} : X \twoheadrightarrow Z_{i_j}$ j th projection,

$$\text{id}_X = \sum_{i=1}^n i_i p_i, \quad p_i i_j = \delta_{i,j} \text{id}_{(X:Z_i) \cdot Z_i},$$

$i_i = \sum_{j=1}^{(X:Z_i)} i_{i,j}$ isotypic inclusion, $p_i = \sum_{j=1}^{(X:Z_i)} p_{i,j}$ isotypic projection.

Handwritten notes: $\mathbb{1} \neq 0 \rightarrow P_{\mathbb{1}}$, \rightarrow (square), $(X:Z_i)$.

(This is just (6-2), but taking multiplicities into account.) The morphisms $i_{i,j}$ and $p_{i,j}$ are unique up to scaling, and i_i and p_i are called the isotypic inclusions and projections, respectively.

Example 9.4 For $\text{End}_C(X)$ as in Example 9.2, but where the simples are only assumed to be indecomposable, we have

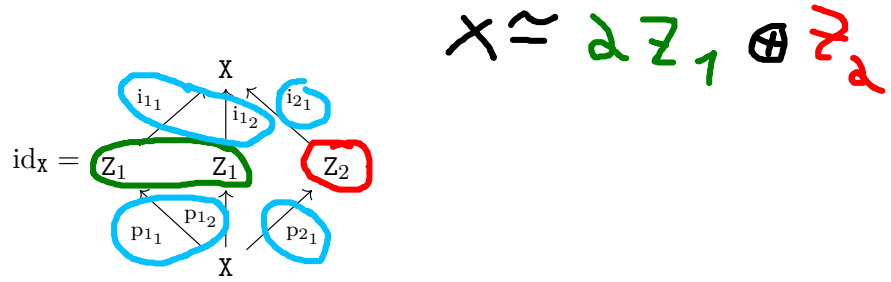

$$i_{1_1} p_{1_1} \leftrightarrow \begin{matrix} & Z_1 & Z_1 & Z_2 \\ Z_1 & \begin{pmatrix} 1 & 0 \\ 0 & 0 \end{pmatrix} & & \\ Z_2 & & & \end{matrix}, \quad i_{1_2} p_{1_2} \leftrightarrow \begin{matrix} & Z_1 & Z_1 & Z_2 \\ Z_1 & \begin{pmatrix} 0 & 0 \\ 0 & 1 \end{pmatrix} & & \\ Z_2 & & & \end{matrix}, \quad i_{2_1} p_{2_1} \leftrightarrow \begin{matrix} & Z_1 & Z_1 & Z_2 \\ Z_1 & \begin{pmatrix} 0 & 0 \\ 0 & 0 \end{pmatrix} & & \\ Z_2 & & & \end{matrix}$$

$$i_{1_1} p_1 \leftrightarrow \begin{matrix} & Z_1 & Z_1 & Z_2 \\ Z_1 & \begin{pmatrix} 1 & 0 \\ 0 & 1 \end{pmatrix} & & \\ Z_2 & & & \end{matrix}, \quad i_{2_2} p_2 \leftrightarrow \begin{matrix} & Z_1 & Z_1 & Z_2 \\ Z_1 & \begin{pmatrix} 0 & 0 \\ 0 & 0 \end{pmatrix} & & \\ Z_2 & & & \end{matrix}$$

Note that the colored zero have to be zero in the semisimple case, by Schur's lemma, but not necessarily in general.

9C. **Feynman diagrams for fiat, tensor and fusion categories.** Let us assume that we have a strict multi fiat category. Then we get, of course, the diagrammatic calculus for pivotal categories as in Section 4G. Additionally, we want to keep track of the morphisms i_{ij} and p_{ij} from (9-2), as well as simples. We use the conventions:

(9-3) $Z_i \leftrightarrow \begin{matrix} i \\ \uparrow \\ i \end{matrix}$, $i_{i_j} \leftrightarrow \begin{matrix} X \\ \uparrow \\ \boxed{j} \\ \uparrow \\ i \end{matrix}$, $p_{i_j} \leftrightarrow \begin{matrix} i \\ \uparrow \\ \boxed{j} \\ \uparrow \\ X \end{matrix}$, $i_i \leftrightarrow \begin{matrix} X \\ \uparrow \\ \square \\ \uparrow \\ i \end{matrix}$, $p_i \leftrightarrow \begin{matrix} i \\ \uparrow \\ \square \\ \uparrow \\ X \end{matrix}$.

(Handwritten notes: A red box highlights the inclusion and projection diagrams. A green box highlights the simple inclusion and projection diagrams. A blue arrow points from the simple inclusion diagram to the matrix $\begin{pmatrix} 1 & 0 \\ 0 & 0 \end{pmatrix}$. A green arrow points from the simple projection diagram to the matrix $\begin{pmatrix} 1 & 0 \\ 0 & 1 \end{pmatrix}$.)

Note that we can distinguish between the inclusions and the projections in (9-3) by the labeling of the strands, so we can just use colored boxes as indicated. The relations in (9-2) then are e.g.

(9-4) $\sum_i \begin{matrix} \uparrow \\ \cdot \\ \uparrow \\ X \end{matrix} = \uparrow$, $\sum_{i=1}^n \begin{matrix} X \\ \uparrow \\ \square \\ \uparrow \\ X \end{matrix} = \uparrow$, $\begin{matrix} i \\ \uparrow \\ \square \\ \uparrow \\ X \end{matrix} = (X : Z_i) \cdot \begin{matrix} i \\ \uparrow \\ \square \\ \uparrow \\ i \end{matrix}$.

(Handwritten notes: A red arrow points from the first equation to the inclusion diagram. A blue arrow points from the second equation to the simple inclusion diagram. A blue arrow points from the third equation to the simple projection diagram. A blue arrow points from the simple inclusion diagram to the matrix $(X : Z_i)$.)

We, of course, still have the topological relations which we have seen, e.g. sliding

$\begin{matrix} \square \\ \uparrow \\ i \end{matrix} = \begin{matrix} \square \\ \uparrow \\ i \end{matrix}$, $\begin{matrix} \square \\ \uparrow \\ i \end{matrix} = \begin{matrix} \square \\ \uparrow \\ i \end{matrix}$, where $\begin{matrix} i \\ \downarrow \\ \square \\ \downarrow \\ X \end{matrix} = \left(\begin{matrix} X \\ \uparrow \\ \square \\ \uparrow \\ i \end{matrix} \right)^*$.

(Handwritten notes: Blue arrows indicate the sliding relations. A checkmark is next to the final equation.)

If our category of interest is additionally braided, then we have the power of the Reidemeister calculus, see Section 5F, as well, e.g.

$\begin{matrix} X & Y & Z \\ \uparrow & \uparrow & \uparrow \\ \square & & \\ \uparrow & & \\ Z & & i \end{matrix} = \begin{matrix} X & Y & Z \\ \uparrow & \uparrow & \uparrow \\ \square & & \\ \uparrow & & \\ Z & & i \end{matrix}$.

(Handwritten notes: A blue arrow points to the first diagram. A checkmark is next to the second diagram.)

Note that this graphical calculus is, having e.g. [Theorem 4.52](#) established, is automatically consisted as we simply used a special notation for special morphisms.

9D. **Traces and dimensions revisited.** Recall that we had the notions of traces and dimensions for pivotal categories, cf. [Section 4H](#). We can say a bit more now. But first an evident lemma:

Lemma 9.5 *Let $\mathbf{C} \in \mathbf{PCat}_\oplus$. Then*

$$\begin{aligned} \text{tr}^{\mathbf{C}}(f \oplus g) &= \text{tr}^{\mathbf{C}}(f) + \text{tr}^{\mathbf{C}}(g), & \mathbf{C}\text{tr}(f \oplus g) &= \mathbf{C}\text{tr}(f) + \mathbf{C}\text{tr}(g), \\ \dim^{\mathbf{C}}(\mathbf{X} \oplus \mathbf{Y}) &= \dim^{\mathbf{C}}(\mathbf{X}) + \dim^{\mathbf{C}}(\mathbf{Y}), & \mathbf{C}\dim(\mathbf{X} \oplus \mathbf{Y}) &= \mathbf{C}\dim(\mathbf{X}) + \mathbf{C}\dim(\mathbf{Y}), \end{aligned}$$

for all $\mathbf{X}, \mathbf{Y} \in \mathbf{C}$ and $(f: \mathbf{X} \rightarrow \mathbf{X}), (g: \mathbf{Y} \rightarrow \mathbf{Y}) \in \mathbf{C}$. □

↙ right trace

↘ left trace

Proposition 9.6 *Let $\mathbf{C} \in \mathbf{PCat}_{\mathbb{K}S}$ and $\mathbf{L} \in \text{Si}(\mathbf{C})$. Then we have*

$$\dim^{\mathbf{C}}(\mathbf{L}) \neq 0, \quad \mathbf{C}\dim(\mathbf{L}) \neq 0.$$

More generally, if $f: \mathbf{L} \xrightarrow{\cong} \mathbf{L}^{**}$ is an isomorphism, then

$$\text{tr}^{\mathbf{C}}(f) \neq 0, \quad \mathbf{C}\text{tr}(f) \neq 0.$$

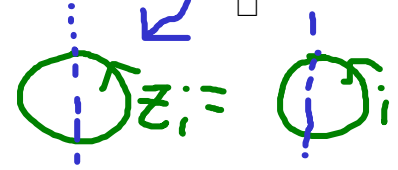

$$\begin{pmatrix} 1 & 0 \\ 0 & 0 \end{pmatrix} \mapsto \text{tr} = 1$$

Proof. Note that $\dim^{\mathbf{C}}(\mathbf{L}) = 0$ would contradict [Schur's lemma Lemma 6.69](#): from $\dim^{\mathbf{C}}(\mathbf{L}) = 0$ we get

$$\dim \text{End}_{\mathbf{C}}(\mathbf{L}) = \dim \text{Hom}_{\mathbf{C}}(\mathbf{L}\mathbf{L}^*, \mathbb{1}) > 1,$$

since we would get a map different from $\text{ev}_{\mathbf{L}}$. Thus, we are done by symmetry as the argument for the traces is exactly the same. □

Example 9.7 *[Proposition 9.6](#) fails in the non-semisimple case, i.e. for $\mathbf{Z} \in \text{In}(\mathbf{C})$*

$$\dim^{\mathbf{C}}(\mathbf{Z}) = 0, \quad \mathbf{C}\dim(\mathbf{Z}) = 0,$$

is possible. To give an explicit example, let us consider the [Rumer–Teller–Weyl category \$\mathbf{TL}_{\mathbb{C}\epsilon}^q\$](#) as in [Definition 7.39](#), and let $q = \exp(2\pi i/4) = i \in \mathbb{C}$. Then the circle removal becomes

$$(9-5) \quad \bigcirc = 0 = \dim^{\mathbf{TL}_{\mathbb{C}\epsilon}^q}(\bullet),$$

and \bullet is, of course, indecomposable. Using (9-5), we also get an isomorphism of \mathbb{C} algebras

$$\text{End}_{\mathbf{TL}_{\mathbb{C}\epsilon}^q}(\bullet^2) \xrightarrow{\cong} \mathbb{C}[X]/(X^2), \quad | \mapsto 1, \quad \smile \mapsto X.$$

This implies that $\text{End}_{\mathbf{TL}_{\mathbb{C}\epsilon}^q}(\bullet^2)$ is a local \mathbb{C} algebra and thus $\bullet^2 \in \text{In}(\mathbf{TL}_{\mathbb{C}\epsilon}^q)$. We also have

$$\bigcirc \rightarrow \text{X} \circ \bigcirc = 0 = \dim^{\mathbf{TL}_{\mathbb{C}\epsilon}^q}(\bullet^2).$$

More general, one can show that

$$(\mathbf{Z} \in \text{In}(\mathbf{TL}_{\mathbb{C}\epsilon}^q)) \Rightarrow (\dim^{\mathbf{TL}_{\mathbb{C}\epsilon}^q}(\mathbf{Z}) = 0 \text{ unless } \mathbb{1} = \mathbf{Z}).$$

✓

$\bigcirc = -q - q^{-1}$

$-i - (i)^{-1}$

$\dim(\bullet) = 0$

$\bigcup \bigcap = 0$

That dimensions of objects are non-zero is in some sense a property of semisimple categories:

Proposition 9.8 *Let $\mathbf{C} \in \mathbf{mlFiat}$. Then the following are equivalent:*

- (I) \mathbf{C} is semisimple;

- (II) $\dim^{\mathbf{C}}(\mathbb{P}) \neq 0$ for all $\mathbb{P} \in \underline{\mathbf{Pi}}(\mathbf{C})$;
- (III) $\dim^{\mathbf{C}}(\mathbb{P}) \neq 0$ for some $\mathbb{P} \in \underline{\mathbf{Proj}}(\mathbf{C})$;
- (IV) $\underline{\mathbf{C}}\dim(\mathbb{P}) \neq 0$ for all $\mathbb{P} \in \underline{\mathbf{Pi}}(\mathbf{C})$;
- (V) $\underline{\mathbf{C}}\dim(\mathbb{P}) \neq 0$ for some $\mathbb{P} \in \underline{\mathbf{Proj}}(\mathbf{C})$.

Proof. (I) \Rightarrow (II). By Proposition 9.6 since all simple objects (and thus, all objects) are projective.

(II) \Rightarrow (III). Evident.

(III) \Rightarrow (I). Consider

$$\mathbb{1} \xrightarrow{\text{coev}^{\mathbb{P}}} \mathbb{P}(*\mathbb{P}) \xrightarrow{\cong} \mathbb{P}\mathbb{P}^* \xrightarrow{\text{ev}^{\mathbb{P}}} \mathbb{1},$$

which calculates $\dim^{\mathbf{C}}(\mathbb{P})$. If this is not zero, then $\mathbb{1} \in \mathbb{P}(*\mathbb{P}) \in \underline{\mathbf{Proj}}(\mathbf{C})$. Thus, Theorem 7.36 implies that \mathbf{C} is semisimple.

Finally, by symmetry, (II) and (III) are equivalent to (IV) and (V), so we are done. □

Lemma 9.9 Let $\mathbf{C} \in \mathbf{mFiat}$ and $X \in \mathbf{C}$. Then we have

$$\underline{\dim}^{\mathbf{C}}(X) = \sum_{i=1}^n (X : Z_i) \underline{\dim}^{\mathbf{C}}(L_i), \quad \underline{\mathbf{C}}\dim(X) = \sum_{i=1}^n (X : Z_i) \underline{\mathbf{C}}\dim(L_i).$$

Proof. An easy calculation using (9-4) and sliding:

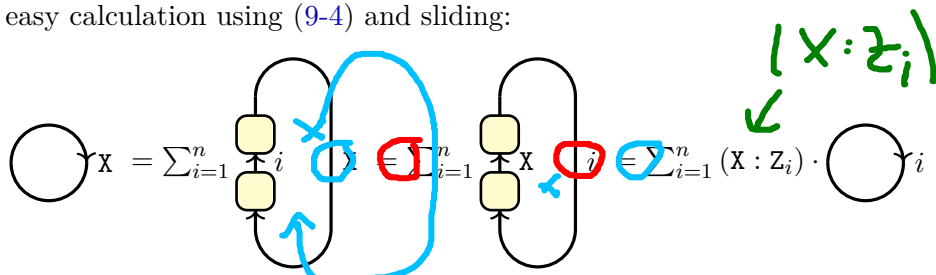

The other cases follows by symmetry. □

Definition 9.10 Let $\mathbf{C} \in \mathbf{mFiat}$. Then the categorical dimension of \mathbf{C} is

$$\text{Dim}(\mathbf{C}) = \sum_{i=1}^n \underline{\mathbf{C}}\dim(Z_i) \underline{\dim}^{\mathbf{C}}(Z_i).$$

Note that, if \mathbf{C} is spherical, then

$$(9-6) \quad \text{Dim}(\mathbf{C}) = \sum_{i=1}^n \underline{\dim}^{\mathbf{C}}(Z_i)^2.$$

Example 9.11 The categorical dimension generalizes familiar concepts:

(i) For $\underline{\mathbf{Vec}}_{\mathbf{k}}$ we get $\underline{\text{Dim}}(\underline{\mathbf{Vec}}_{\mathbf{k}}) = 1 = \underline{\text{PFdim}}(\underline{\mathbf{Vec}}_{\mathbf{k}})$.

(ii) For $\underline{\mathbf{Vec}}_{\mathbb{C} \oplus}^{\omega}(\mathbb{Z}/2\mathbb{Z})$ we have already seen that there were two choices of pivotal structures giving

$$(9-7) \quad \text{choice 1: } \bigcirc \curvearrowright 1 = 1 = 1 \curvearrowleft \bigcirc, \quad \text{choice 2: } \bigcirc \curvearrowright 1 = -1 = 1 \curvearrowleft \bigcirc.$$

The same work for a trivial ω , i.e. there are also two choices of (co)evaluations satisfying (9-7). Thus, for both choices, we get

$$\begin{aligned} \text{Dim}(\mathbf{Vec}_{\mathbb{C}\oplus}(\mathbb{Z}/2\mathbb{Z})) &= \text{Dim}(\mathbf{Vec}_{\mathbb{C}\oplus}^{\omega}(\mathbb{Z}/2\mathbb{Z})) = 2 = \#(\mathbb{Z}/2\mathbb{Z}) \\ &= \text{PFdim}(\mathbf{Vec}_{\mathbb{C}\oplus}(\mathbb{Z}/2\mathbb{Z})) = \text{PFdim}(\mathbf{Vec}_{\mathbb{C}\oplus}^{\omega}(\mathbb{Z}/2\mathbb{Z})). \end{aligned}$$

(iii) For the non-spherical category such as $\mathbf{Vec}_{\mathbb{C}\oplus}(\mathbb{Z}/3\mathbb{Z})$ with the choice of (co)evaluations from Example 4.59 we get

$$\text{Dim}(\mathbf{Vec}_{\mathbb{C}\oplus}(\mathbb{Z}/3\mathbb{Z})) = 3 = \#(\mathbb{Z}/3\mathbb{Z}) = \text{PFdim}(\mathbf{Vec}_{\mathbb{C}\oplus}(\mathbb{Z}/3\mathbb{Z})).$$

Proposition 9.12 Let $\mathbf{C} \in \mathbf{mFus}$ be spherical and \mathbb{k} be of characteristic zero. Then $\text{Dim}(\mathbf{C}) \neq 0$. Moreover, if $\mathbb{k} = \mathbb{C}$, then $\text{Dim}(\mathbf{C}) \geq 1$.

Proof. Since \mathbf{C} is spherical, we have (9-6) which immediately implies the claims. □

Example 9.13 Proposition 9.12 does not hold in finite characteristic. For example, with reference to Example 9.11.(b), we have

$$\text{Dim}(\mathbf{Vec}_{\mathbb{F}_2\oplus}(\mathbb{Z}/2\mathbb{Z})) = 2 = 0 \in \text{End}_{\mathbf{Vec}_{\mathbb{F}_2\oplus}(\mathbb{Z}/2\mathbb{Z})}(\mathbb{1}) \cong \mathbb{F}_2.$$

Note however that

$$\text{PFdim}(\mathbf{Vec}_{\mathbb{F}_2\oplus}(\mathbb{Z}/2\mathbb{Z})) = 2 \neq 0,$$

since the PF dimension is, by definition, an element in $\mathbb{R}_{\geq 0}$.

Note that Example 9.13 also illustrates a crucial difference between the categorical dimension and the PF dimension: The first is a categorical notion, is about morphisms, and lives in \mathbf{C} . On the other hand, the PF dimension is a numerical notion, is about objects and lives in $\mathbb{R}_{\geq 0}$.

9E. The Alexander–Markov theorem and traces of braids. Recall that we had the category of braids \mathbf{qSym} , see Example 5.15, which is the free braided category generated by one object. In particular, we get the Alexander functor

$$(9-8) \quad \mathbf{A}: \mathbf{qSym} \rightarrow \mathbf{oqBr}, \quad \bullet \mapsto \bullet, \quad \text{crossing} \mapsto \text{cup/cap}$$

The Markov quotient of \mathbf{qSym} , denoted by $\mathbf{qSym}/\mathbf{MM}$, is the quotient of \mathbf{qSym} by the congruence spanned by the Markov moves MM. Formally:

Definition 9.14 We let $\mathbf{qSym}/\mathbf{MM} = \langle \mathbf{S}, \mathbf{T} \mid \mathbf{R} \cup \mathbf{MM} \rangle$ with

$$\mathbf{S}: \bullet, \quad \mathbf{T}: \text{crossing} : \bullet^2 \rightarrow \bullet^2, \quad \mathbf{R}: \text{crossing} = \text{cup} = \text{cap}, \quad \text{crossing} = \text{crossing}$$

$$(9-9) \quad \text{MM: } \begin{array}{c} \text{cup} \\ \text{cap} \end{array} = \begin{array}{c} \text{cup} \\ \text{cap} \end{array}, \quad \begin{array}{c} \text{cup} \\ \text{cap} \end{array} = \begin{array}{c} \text{cup} \\ \text{cap} \end{array}, \quad \begin{array}{c} \text{cup} \\ \text{cap} \end{array} = \begin{array}{c} \text{cup} \\ \text{cap} \end{array}$$

(The Markov moves are imposed for all possible number of strands and all morphisms f and g .)

By definition, we have a full quotient functor

$$M: \mathbf{qSym} \rightarrow \mathbf{qSym}/\mathbf{MM}, \quad \bullet \mapsto \bullet, \quad \begin{array}{c} \diagup \\ \diagdown \end{array} \mapsto \begin{array}{c} \diagdown \\ \diagup \end{array}.$$

The classical **Alexander–Markov theorem** takes now the following form:

Theorem 9.15 We have the following.

(i) The functor A from (9-8) is fully faithful. ✓

(ii) The functor A gives a surjection

$$(9-10) \quad A: \bigcup_{n \in \mathbb{N}} \mathbf{End}_{\mathbf{qSym}}(\bullet^n) \twoheadrightarrow \mathbf{End}_{\mathbf{oqBr}}(\mathbb{1}), \quad f \mapsto \mathbf{tr}^{\mathbf{oqBr}}(A(f)).$$

(iii) There exists a bijection

$$AM^{-1}: \bigcup_{n \in \mathbb{N}} \mathbf{End}_{\mathbf{qSym}/\mathbf{MM}}(\bullet^n) \xrightarrow{\cong} \mathbf{End}_{\mathbf{oqBr}}(\mathbb{1}),$$

making the following diagram (in **Set**) commutative:

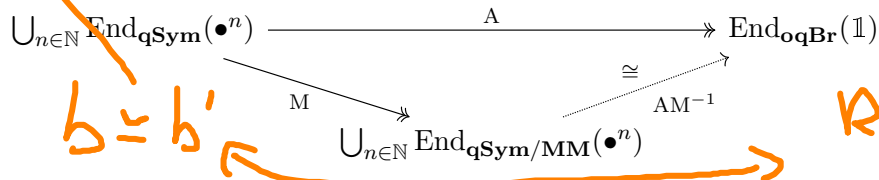

any braid appears

$b = b'$

R, M or MM

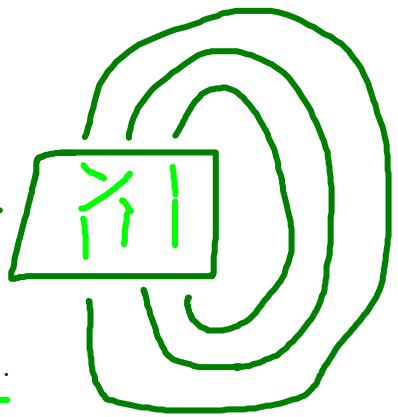

(ii) and (iii) work also for left instead of right traces.

Proof. A proof can be found in e.g. [KT08, Chapter 2]. □

In words, **Theorem 9.15.(ii)** says that every link arises as a closure of a braid, see **Example 9.16**, while **Theorem 9.15.(iii)** gives a precise condition for when two closures represent the same link.

Example 9.16 The Alexander closure A from (9-10) can be illustrated by “closing a braid to the right”:

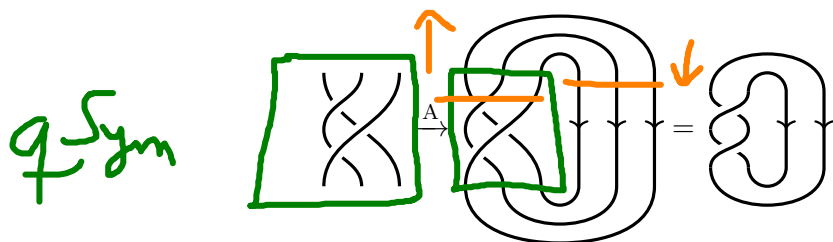

The surprising result of Alexander is then that every link can be arranged such that it has a purely upward-oriented and a purely downward-oriented part, with the latter being trivial. The Markov moves then just take the form of sliding and Reidemeister 1:

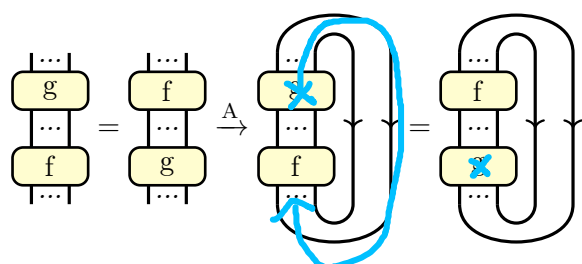

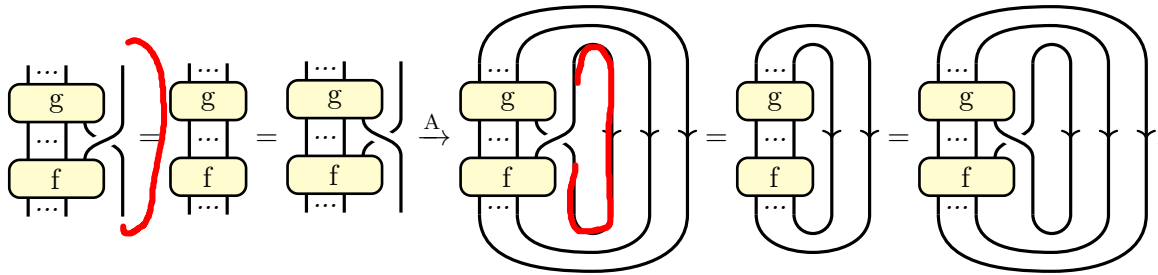

These evidently hold in **oqBr**. (See also [Exercise 9.47](#).) The point of [Theorem 9.15](#).(iii) is that these are the only extra relations.

Remark 9.17 The functor in (9-8) has, of course, various cousins, e.g. we could equally well go to **qBr**. Similarly for the Alexander–Markov theorem [Theorem 9.15](#), which exists in a variety of flavors.

9F. **Colored braids and links.** The previous section is partially a motivation for the following. More general than [Section 9E](#), if $\mathbf{C} \in \mathbf{BCat}$ is any braided category and $X \in \mathbf{C}$ is any object, then we get a coloring with X functor

$$A_X: \mathbf{qSym} \rightarrow \mathbf{C}, \quad \bullet \mapsto X, \quad \text{crossing} \mapsto \begin{array}{c} X \quad X \\ \diagdown \quad \diagup \\ \diagup \quad \diagdown \\ X \quad X \end{array} \quad \beta: XX \rightarrow XX$$

Similarly, if $\mathbf{C} \in \mathbf{BPCat}$ is any braided pivotal category and $X \in \mathbf{C}$ is any object, then we have a more general coloring with X functor

$$A_X^*: \mathbf{oqBr} \rightarrow \mathbf{C}, \quad \bullet \mapsto X, \quad \text{crossing} \mapsto \begin{array}{c} X \quad X \\ \diagdown \quad \diagup \\ \diagup \quad \diagdown \\ X \quad X \end{array}, \quad \text{cup} \mapsto \begin{array}{c} \text{cup} \\ X \quad X \end{array}, \quad \text{cap} \mapsto \begin{array}{c} X \quad X \\ \text{cap} \\ X \quad X \end{array}, \quad \text{cup} \mapsto \begin{array}{c} X \quad X \\ \text{cup} \\ X \quad X \end{array}.$$

Remark 9.18 The coloring functors as above have the “flaw” that one can only color with one color at a time. This can be corrected by considering the **category of colored braids** **cqSym** or the **colored oriented quantum Brauer category** **coqBr**. The images of the coloring functors are then called **colored braids** or **colored (oriented) tangles**, respectively.

Our main target for coloring functors (which thus, allow a diagrammatic calculus of colored tangles) are:

Definition 9.19 Let $\mathbf{C} \in \mathbf{mlFiat}$. Then:

- mss • If $\mathbf{C} \in \mathbf{BCat}$, then we call it a **multi locally bfiat category**. The corresponding category is denoted by mlBfiat.
- ss • If $\mathbf{C} \in \mathbf{BCat}_S$, then we call it a **multi locally bmodular category**. The corresponding category is denoted by mlBMo.
- Finally, if these satisfy the ribbon equation (5-18), then we call them **rfiat** or **rmodular**, with the corresponding notation for the categories.

Remark 9.20 A rmodular category is also called a **pre-modular category** in the literature. Note also the hierarchy in the definitions above.

Example 9.21 We have already seen plenty of examples:

- (a) Of course, $\text{Vec}_{\mathbb{k}}$ is bmodular.
- (b) More generally, $\text{Vec}_{\mathbb{k} \oplus}^{\omega}(G)$ is bmodular if and only if G is a finite abelian group.
- (c) For G being a finite group the category $\text{fdMod}(\mathbb{C}[G])$ is bmodular.
- (d) More generally, let \mathbb{K} be algebraically closed and assume that the condition in Proposition 8.6.(iii) holds. Then $\text{fdMod}(\mathbb{K}[G])$ is bfiat.

Example 9.22 Whether a bfiat or bmodular is ribbon is trickier, as this depends on choices. Let us discuss $\text{Vec}_{\mathbb{C} \oplus}(\mathbb{Z}/3\mathbb{Z})$ in details, where we recall [Example 4.59](#) and [Lemma 5.25](#). In particular, there are several choices of (co)evaluations and braidings given as follows. (Some are equivalent, but let us just list them anyways.) Let

$$d_k(i) = \zeta^{ij}, \quad i, k \in \{0, 1, 2\},$$

where $\zeta = \exp(2\pi i/3) \in \mathbb{C}$. Then, for $k, l, m \in \{0, 1, 2\}$,

$$\begin{array}{c} \text{cap} \\ \text{cup} \end{array} = 1, \quad \begin{array}{c} \text{cup} \\ \text{cap} \end{array} = 1, \quad \begin{array}{c} \text{cup} \\ \text{cup} \end{array} = d_k(i), \quad \begin{array}{c} \text{cap} \\ \text{cap} \end{array} = d_k(i)^{-1}, \quad \begin{array}{c} \text{cross} \\ \text{cross} \end{array} = d_l(i)d_m(j),$$

are choices. We then check that

$$\begin{array}{c} \text{loop} \\ \text{loop} \end{array} = d_k(i)^{-1}d_l(i)^2 \cdot \begin{array}{c} \text{loop} \\ \text{loop} \end{array}, \quad \begin{array}{c} \text{loop} \\ \text{loop} \end{array} = d_k(i)d_l(i)^2 \cdot \begin{array}{c} \text{loop} \\ \text{loop} \end{array}.$$

In particular, being ribbon does not depend on the choice of braiding, but is equivalent to $\text{Vec}_{\mathbb{C} \oplus}(\mathbb{Z}/3\mathbb{Z})$ being spherical.

Recall that for a $\mathbf{C} \in \mathbf{BFiat}$ being \mathbb{S} linear we have a finite set of indecomposables $\text{In}(\mathbf{C}) = \{Z_1, \dots, Z_n\}$ and also $\text{End}_{\mathbf{C}}(\mathbb{1}) \cong \mathbb{S}$, and we can consider the colored Hopf braid

$$s_{ij} = \beta_{Z_j, Z_i} \beta_{Z_i, Z_j} = \begin{array}{c} Z_i \ Z_j \\ \text{cross} \\ Z_i \ Z_j \end{array}, \quad \text{tr}^{\mathbf{C}}(s_{ij}) = \begin{array}{c} \text{trace} \\ \text{trace} \end{array} \begin{array}{c} Z_j \ Z_i \\ \text{loop} \\ Z_j \ Z_i \end{array} \in \mathbb{S}.$$

These assemble into an important $n \times n$ matrix, called the S matrix

$$S = (\text{tr}^{\mathbf{C}}(s_{ij}))_{i,j=1}^n \in \text{Mat}_{n \times n}(\mathbb{S}).$$

Note that, if the braiding is symmetric, then

$$\text{tr}^{\mathbf{C}}(s_{ij}) = \begin{array}{c} \text{trace} \\ \text{trace} \end{array} \begin{array}{c} \text{loop} \\ \text{loop} \end{array} \begin{array}{c} Z_j \ Z_i \\ \text{loop} \\ Z_j \ Z_i \end{array} = \begin{array}{c} \text{loop} \\ \text{loop} \end{array} \begin{array}{c} Z_j \ Z_i \\ \text{loop} \\ Z_j \ Z_i \end{array} = \dim^{\mathbf{C}}(Z_i) \dim^{\mathbf{C}}(Z_j) \in \mathbb{S}.$$

Example 9.23 Let us discuss the case of $\text{Vec}_{\mathbb{k} \oplus}(G)$ for small G .

$\mathbb{1} = \mathbb{1}$

(a) Recall from [Example 6.23](#) that $\mathbf{Vec}_{\mathbb{C}\oplus}(\mathbb{Z}/2\mathbb{Z})$ has two braidings. However, both satisfy $s_{ij} = \text{id}_{L_i L_j}$. So they give the same result for the S matrix. Moreover, recall that $\mathbf{Vec}_{\mathbb{C}\oplus}(\mathbb{Z}/2\mathbb{Z})$ has two choices (co)evaluations, see [Example 4.64](#). For these we get

choice 1: $S = \begin{pmatrix} 1 & 1 \\ 1 & 1 \end{pmatrix}$, $\det(S) = 0$, choice 2: $S = \begin{pmatrix} 1 & -1 \\ -1 & 1 \end{pmatrix}$, $\det(S) = 0$.

(b) For $\mathbf{Vec}_{\mathbb{C}\oplus}(\mathbb{Z}/3\mathbb{Z})$, enumerate $\text{Si}(\mathbf{Vec}_{\mathbb{C}\oplus}(\mathbb{Z}/3\mathbb{Z})) = \{0, 1, 2\}$, let $\zeta = \exp(2\pi i/3)$ and take a braiding such that $s_{ij} = \zeta^{i+j}$. Then, for the standard rigidity structure,

$S = \begin{pmatrix} 1 & \zeta & \zeta^2 \\ \zeta & \zeta^2 & 1 \\ \zeta^2 & 1 & \zeta \end{pmatrix}$, $\det(S) = 0$. *← do not like*

Example 9.24 Back to S_3 , cf. [Example 8.15](#): The category $\mathbf{fdMod}(\mathbb{C}[S_3])$ with the swap map as the braiding and the usual (co)evaluations is fiat. With this choice the categorical dimension is just the dimension as a \mathbb{C} vector space. Thus, since the braiding is symmetric, we get

$S = \begin{pmatrix} 1 & 2 & 1 \\ 2 & 4 & 2 \\ 1 & 2 & 1 \end{pmatrix}$, $\det(S) = 0$.

Lemma 9.25 For $\mathbf{C} \in \mathbf{BFiat}$ and any $Z_i \in \text{In}(\mathbf{C})$ we have

$s_{ij}s_{ik} = \dim^{\mathbf{C}}(Z_i) \cdot \sum_{l=1}^n N_{jk}^l s_{il}$.

Proof. The diagrammatic equation

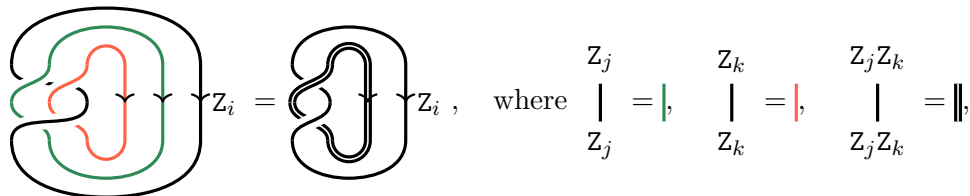

and additivity provide the result. □

Example 9.26 In [Example 9.24](#) we can easily check that for $i = 2 = j$ and $k = 1$ we have $8 = 2(0 \cdot 2 + 1 \cdot 4 + 0 \cdot 2)$.

Lemma 9.27 Any $\mathbf{C} \in \mathbf{BFiat}$ has a symmetric S matrix.

Proof. A Reidemeister-type argument:

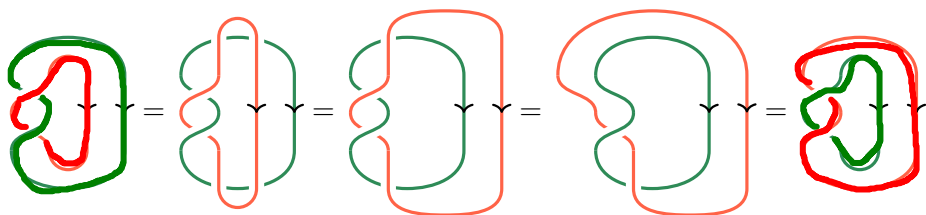

(The colors are meant to represent colorings with objects.) □

Let us continue this section with an important lemma which should remind us that the Reidemeister 1 move (5-17) “is not as innocent as it looks”.

Lemma 9.28 Let $\mathbf{C} \in \mathbf{mBFiat}$ be \mathbb{K} linear and $Z \in \text{In}(\mathbf{C})$ and \mathbb{K} algebraically closed. There exists $a(Z) \in \mathbb{K}^*$ such that

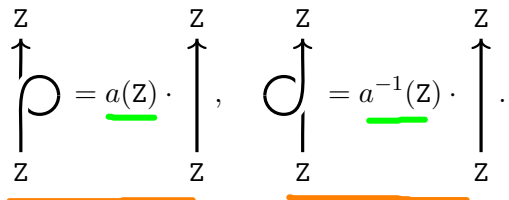
(9-11)  R1 might fail

Proof. After recalling that the twist is invertible with explicit inverse as given in Lemma 5.35, this is a direct consequence of Schur’s lemma Lemma 6.69 if Z is simple. For general Z we also use Schur’s lemma Lemma 6.68 and additionally observe that the invertible elements in a local ring can be identified with the ground field. \square

For $\mathbf{C} \in \mathbf{IBFiat}$ we let

$$\Delta_r = \sum_{i=1}^n \left[\text{diagram of two strands with a twist} \right], \quad \Delta_l = \sum_{i=1}^n \left[\text{diagram of two strands with a twist} \right]$$

both of which are in $\text{End}_{\mathbf{C}}(\mathbb{1}) \cong \mathbb{S}$.

Lemma 9.29 Let $\mathbf{C} \in \mathbf{IBFiat}$ be \mathbb{K} linear. Then:

- (i) We have $\Delta_r = \sum_{i=1}^n a(Z_i) \dim^{\mathbf{C}}(Z_i)^2$ and $\Delta_l = \sum_{i=1}^n a(Z_i)^{-1} \dim^{\mathbf{C}}(Z_i)^2$.
- (ii) If \mathbf{C} is semisimple, then $\Delta_r = \sum_{i=1}^n a(Z_i)^{\mathbf{C}} \dim^{\mathbf{C}}(Z_i)^2$ and $\Delta_l = \sum_{i=1}^n a(Z_i)^{-1} \dim^{\mathbf{C}}(Z_i)^2$.

$\Delta = \sum a^{-1} \dim^2$

Proof. An immediate consequence of Lemma 9.28. \square

9G. Modular categories. The S matrix is symmetric, but e.g. Example 9.23 shows that it might not be invertible. So:

Definition 9.30 A category $\mathbf{C} \in \mathbf{BFiat}$ with invertible S matrix is called **mfiat**. If such a \mathbf{C} is additionally semisimple, then \mathbf{C} is called modular.

The corresponding categories are denoted by MoFiat and MoCat.

Example 9.31 Back to Example 9.21:

- (a) The category Vec_k is modular.
- (b) However, Vec_{k⊕}^ω(G) is rarely modular, cf. Example 9.23. (See also [EGNO15, Example 8.13.5].)
- (c) For G being a finite group the category fdMod(C[G]) is only modular if G is the trivial group.

(7)

(d) More generally, whenever the categorical dimension is equal to the vector space dimension a category with more than one indecomposable object can not be modular.

Example 9.32 The Verlinde categories, cf. Section 8F, are all modular.

The topological motivation for Definition 9.30 is:

Proposition 9.33 Let $\mathbf{C} \in \mathbf{BFiat}$ be \mathbb{k} linear. Then $\mathbf{C} \in \mathbf{MoFiat}$ if and only if $\mathbb{1}$ is the only indecomposable object such that

(9-12) $\beta_{Z, \mathbb{1}} \beta_{\mathbb{1}, Z} = \text{id}_{\mathbb{1}Z}, \quad \beta_{\mathbb{1}, Z} \beta_{Z, \mathbb{1}} = \text{id}_{Z\mathbb{1}}, \quad \text{for all } Z \in \text{In}(\mathbf{C}).$

$[3] = 3$

Proof. This is Exercise 9.50.

braid trivially $q=1$ \square

9H. **More on Rumer–Teller–Weyl categories.** Let us come back to $\mathbf{TL}_{\mathbb{S} \oplus \mathbb{C}}^q$ as in Definition 7.39. This category usually has infinitely many simple and indecomposable objects, but it has nice quotients. Here we use the usual quantum numbers, i.e. for $a \in \mathbb{N}$ we let $[0]_q = 0$, $[1]_q = 1$ and

(9-13) $[a]_q = q^{a-1} + q^{a-3} + \dots + q^{-a+3} + q^{-a+1} \in \mathbb{S}$

$[2] = q + q^{-1}$ $[3] = q^2 + 1 + q^{-2}$

$0 = [2]$

For $a \in \mathbb{Z}_{<0}$ we let $[a]_q = -[-a]_q$. To this end, we need the following:

Example 9.34 Note that $[a]_q$ depends on the choice of q . To be explicit let $\mathbb{S} = \mathbb{C}$ and let q be either 1, $\zeta_2 = i = \exp(2\pi i/4)$, $\zeta_3 = \exp(2\pi i/3)$, $\zeta_4 = \exp(2\pi i/8)$, or $\zeta_5 = \exp(2\pi i/5)$. Then

	$[1]_q$	$[2]_q$	$[3]_q$	$[4]_q$	$[5]_q$	$[6]_q$	$[7]_q$	$[8]_q$
$q = 1$	1	2	3	4	5	6	7	8
$q = \zeta_2$	1	0	-1	0	1	0	-1	0
$q = \zeta_3$	1	-1	0	1	-1	0	1	-1
$q = \zeta_4$	1	$\sqrt{2}$	1	0	-1	$-\sqrt{2}$	-1	0
$q = \zeta_5$	1	$\frac{1}{2}(-1 + \sqrt{5})$	$\frac{1}{2}(1 - \sqrt{5})$	-1	0	1	$\frac{1}{2}(-1 + \sqrt{5})$	$\frac{1}{2}(1 - \sqrt{5})$

$q^2 = 1 \rightarrow$
 $q^3 = 1 \rightarrow$

(Note the difference between whether the i in ζ_i is even or odd.)

Definition 9.35 Let $q^2 \in \mathbb{C}^*$ be not a second or third primitive root of unity. For $i = 0, 1, 2, 3$ define the i th Jones–Wenzl idempotent (JW idempotent for short) $\text{JW}_i \in \text{End}_{\mathbf{TL}_{\mathbb{C} \oplus \mathbb{C}}^q}(\bullet^i)$ as follows:

$\text{JW}_0 = \emptyset, \quad \text{JW}_1 = \text{cap}, \quad \text{JW}_2 = \text{cap} + \frac{[1]_q}{[2]_q} \text{cup},$
 $\text{JW}_3 = \text{cap} + \frac{[2]_q}{[3]_q} \text{cup} + \frac{[2]_q}{[3]_q} \text{cup} + \frac{[1]_q}{[3]_q} \text{cup} + \frac{[1]_q}{[3]_q} \text{cup}$

Example 9.36 A calculation shows that we have the traces

$\text{tr}_{\mathbf{TL}_{\mathbb{C} \oplus \mathbb{C}}^q}(\text{JW}_i) = (-1)^{i+1} [i+1]_q.$

$11 + \frac{1}{2} \cup$

For example, we calculate

$\text{tr}_{\mathbf{TL}_{\mathbb{C} \oplus \mathbb{C}}^q}(\text{JW}_2) = \text{cap} + \frac{[1]_q}{[2]_q} \text{cup} = [2]_q^2 - 1 = [3]_q,$

and

$$\begin{aligned}
 \mathrm{tr}^{\mathbf{TL}_{\mathbb{C} \oplus \mathbb{C}}^q}(\mathrm{JW}_3) &= \text{Diagram 1} + \frac{[2]_q}{[3]_q} \cdot \text{Diagram 2} + \frac{[2]_q}{[3]_q} \cdot \text{Diagram 3} \\
 &+ \frac{[1]_q}{[3]_q} \cdot \text{Diagram 4} + \frac{[1]_q}{[3]_q} \cdot \text{Diagram 5} \\
 &= \frac{1}{[3]_q} (-[2]_q^3 [3]_q + [2]_q^3 + [2]_q^3 - [2]_q - [2]_q) = -[4]_q.
 \end{aligned}$$

Lemma 9.37 The JW projectors as in Definition 9.35 are idempotents.

Proof. This is an exercise, cf. Exercise 9.51. □

Definition 9.38 Let $q^2 \in \mathbb{C}^*$ be a primitive fourth root of unity. We define the level 4 semisimplified quotient $\mathbf{TL}_{\mathbb{C} \oplus \mathbb{C}}^4$ of $\mathbf{TL}_{\mathbb{C} \oplus \mathbb{C}}^q$ to be

$$\mathbf{TL}_{\mathbb{C} \oplus \mathbb{C}}^4 = \mathbf{TL}_{\mathbb{C} \oplus \mathbb{C}}^q / \langle (\bullet^3, \mathrm{JW}_3) \rangle,$$

← assume exists

where the quotient is given by taking the \otimes ideal generated by the object $(\bullet^3, \mathrm{JW}_3)$.

Recall that we can identify objects of the idempotent completion with $\mathrm{Im}(e)$, see Section 7C.

Proposition 9.39 We have the following.

(i) We have $\mathbf{TL}_{\mathbb{C} \oplus \mathbb{C}}^4 \in \mathbf{MoCat}$.

(ii) We have $\mathrm{Si}(\mathbf{TL}_{\mathbb{C} \oplus \mathbb{C}}^4) = \{\mathrm{Im}(\mathrm{JW}_0) = \mathbb{1}, L_1 = \mathrm{Im}(\mathrm{JW}_1), L_2 = \mathrm{Im}(\mathrm{JW}_2)\}$.

(iii) The fusion rules are

\otimes	L_1	L_2
L_1	$\mathbb{1} \oplus L_2$	L_1
L_2	L_1	$\mathbb{1}$

Verlinde

(iv) We have

$$\mathbf{TL}_{\mathbb{C} \oplus \mathbb{C}}^4 \simeq_{\mathbb{C} \oplus \mathbb{C}} \mathbf{fdMod}_4^q(\mathfrak{sl}_2).$$

Proof. Let us postpone the proof to a later section, but let us calculate the S matrix of $\mathbf{TL}_{\mathbb{C} \oplus \mathbb{C}}^4 \in \mathbf{Mo}$, i.e. we need to compute *colored Jones polynomial* of the Hopf link. We do this calculation generically, i.e. keeping q a formal variable, and specialize q in the end. We also use the diagrammatic notation

$$\begin{array}{c} \mathbb{1} \\ | \\ \mathbb{1} \end{array} = \begin{array}{c} | \\ | \\ | \end{array}, \quad \begin{array}{c} L_1 \\ | \\ L_1 \end{array} = \begin{array}{c} | \\ | \\ | \end{array}, \quad \begin{array}{c} L_2 \\ | \\ L_2 \end{array} = \begin{array}{c} | \\ | \\ | \end{array}.$$

We note that we have the crossing formulas

$$\begin{array}{c} \diagdown \\ \diagup \end{array} = \begin{array}{c} | \\ | \end{array}, \quad \begin{array}{c} \diagup \\ \diagdown \end{array} = \begin{array}{c} / \\ / \end{array}, \quad \begin{array}{c} \diagdown \\ \diagdown \end{array} = q^{1/2} \cdot \begin{array}{c} | \\ | \end{array} + q^{-1/2} \cdot \begin{array}{c} \diagup \\ \diagup \end{array},$$

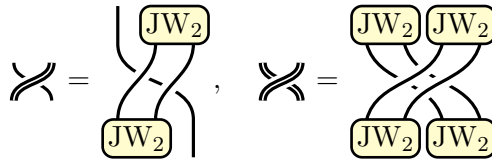

including mirrors. Using these we compute (also with reference to Example 7.42)

$$\begin{aligned} \text{tr}^{\mathbf{C}}(s_{11}) &= [1]_q, & \text{tr}^{\mathbf{C}}(s_{11}) &= \text{tr}^{\mathbf{C}}(s_{11}) = \text{tr}^{\mathbf{C}}(s_{11}) = -[2]_q, & \text{tr}^{\mathbf{C}}(s_{11}) &= \text{tr}^{\mathbf{C}}(s_{11}) = [4]_q, \\ \text{tr}^{\mathbf{C}}(s_{12}) &= \text{tr}^{\mathbf{C}}(s_{21}) = [3]_q, & \text{tr}^{\mathbf{C}}(s_{12}) &= \text{tr}^{\mathbf{C}}(s_{21}) = -[6]_q, \\ \text{tr}^{\mathbf{C}}(s_{22}) &= [9]_q. \end{aligned}$$

Thus, we get the S matrix

$$S = \begin{pmatrix} [1]_q & -[2]_q & [3]_q \\ -[2]_q & [4]_q & -[6]_q \\ [3]_q & -[6]_q & [9]_q \end{pmatrix} = \begin{pmatrix} 1 & -\sqrt{2} & 1 \\ -\sqrt{2} & 0 & \sqrt{2} \\ 1 & \sqrt{2} & 1 \end{pmatrix}, \quad \det(S) = -8,$$

which shows that S is invertible □

Example 9.40 The category $\mathbf{TL}_{\mathbb{C} \oplus \epsilon}^k$ from Definition 9.38 exists more general for any $k \in \mathbb{N}_{\geq 2}$, and we one gets

$$\mathbf{TL}_{\mathbb{C} \oplus \epsilon}^k \simeq_{\mathbb{C} \oplus \star} \mathbf{fdMod}_k^q(\mathfrak{sl}_2) \in \mathbf{Mo}.$$

Moreover, the S matrix of is

$$S = (\text{tr}^{\mathbf{TL}_{\mathbb{C} \oplus \epsilon}^k}(s_{ij}))_{i,j=0}^{k-1}, \quad \text{tr}^{\mathbf{TL}_{\mathbb{C} \oplus \epsilon}^k}(s_{ij}) = (-1)^{i+j} [(i+1)(j+1)]_q.$$

9I. Modular formulas. The purpose of this section is to indicate the “Why?” of modular categories, which will be further justified in the upcoming sections.

Remark 9.41 As we will see in Section 9J, modular categories have “good reasons” to have nice number theoretical properties. We are not giving proofs, as this is not our main purpose. (There are more formulas than the ones given below, see e.g. [EGNO15, Chapter 8].)

We have three important matrices for $\mathbf{C} \in \mathbf{BFiat}$:

- The S matrix which we have already seen in Section 9F;
- The T matrix

Hand

$$t_{ij} = \delta_{i,j} a(Z_i), \quad T = (t_{ij})_{i,j=1}^n \in \text{Mat}_{n \times n}(\mathbb{S}),$$

which is a diagonal matrix having the scalars from (9-11) on the diagonal;

Handwritten: $\begin{matrix} | \\ \swarrow \\ \downarrow \\ \searrow \\ | \end{matrix} = a; !$

- The C matrix

" = id "

$$c_{ij} = \delta_{i,j^*}, \quad C = (c_{ij})_{i,j=1}^n \in \text{Mat}_{n \times n}(\mathbb{S}),$$

which is the $n \times n$ identity matrix if every object is self-dual.

*: $\{L_1, \dots, L_n\}$
 $C = \text{Perm.}$

Proposition 9.42 Let $\mathbf{C} \in \text{MoCat}$ be \mathbb{k} linear. Then:

- (i) We have $\Delta_r, \Delta_l \in \mathbb{k}^*$.
- (ii) We have $\text{Dim}(\mathbf{C}) = \Delta_r \Delta_l$, which is non-zero.
- (iii) We have $C^2 = \text{id}_n$, where id_n is the $n \times n$ identity matrix.
- (iv) We have $S^2 = \text{Dim}(\mathbf{C}) \cdot C$.
- (v) We have $S^4 = \text{Dim}(\mathbf{C})^2 \cdot \text{id}_n$.
- (vi) We have $(ST)^3 = \Delta_r \cdot S^2 = \text{Dim}(\mathbf{C}) \Delta_r \cdot C$.
- (vii) We have $TC = CT$.

Proof. See [TV17, Section 4.5.2] and [EGNO15, Proposition 8.14.2 and Theorem 8.16.1]. □

Example 9.43 Let us come back to Proposition 9.39 and the calculations therein. We have

$$\begin{aligned} a(\mathbb{1}) &= 1, & a(L_1) &= -q^{-3/2}, & a(L_2) &= q^{-4} = -1, \\ \dim^{\mathbf{C}}(\mathbb{1}) &= [1]_q = 1, & \dim^{\mathbf{C}}(L_1) &= -[2]_q = -\sqrt{2}, & \dim^{\mathbf{C}}(L_2) &= [3]_q = 1, \\ \text{Dim}(\mathbf{C}) &= [1]_q^2 + [2]_q^2 + [3]_q^2 = 4, \\ \Delta_r &= [1]_q^2 - q^{-3/2}[2]_q^2 + q^{-4}[3]_q^2 = -2 \exp(\pi i 5/8), & \Delta_l &= [1]_q^2 - q^{3/2}[2]_q^2 + q^4[3]_q^2 = 2 \exp(\pi i 3/8), \\ & & & & & 4 = (-2 \exp(\pi i 5/8))(2 \exp(\pi i 3/8)). \end{aligned}$$

Moreover, the matrix C is the identity and we have

$$S^2 = \begin{pmatrix} 1 & -\sqrt{2} & 1 \\ -\sqrt{2} & 0 & \sqrt{2} \\ 1 & \sqrt{2} & 1 \end{pmatrix} \cdot \begin{pmatrix} 1 & -\sqrt{2} & 1 \\ -\sqrt{2} & 0 & \sqrt{2} \\ 1 & \sqrt{2} & 1 \end{pmatrix} = \begin{pmatrix} 4 & 0 & 0 \\ 0 & 4 & 0 \\ 0 & 0 & 4 \end{pmatrix}.$$

Finally, we also calculate that

$$(ST)^3 = \begin{pmatrix} -8 \exp(\pi i 5/8) & 0 & 0 \\ 0 & -8 \exp(\pi i 5/8) & 0 \\ 0 & 0 & -8 \exp(\pi i 5/8) \end{pmatrix}.$$

Recall that $\dim^{\mathbf{C}}(L) \in \mathbb{k}^*$ if \mathbf{C} is semisimple, see Proposition 9.6. The Verlinde formula, which is up next, gives us the surprising result that the S matrix is in some sense encoded on the Grothendieck classes:

Proposition 9.44 Let $\mathbf{C} \in \text{MoCat}$ be \mathbb{k} linear. Then we have

$$\text{Dim}(\mathbf{C}) N_{jk}^l = \sum_{i=1}^n \frac{s_{ij} s_{ik} s_{il^*}}{\dim^{\mathbf{C}}(L_i)} \leftarrow$$

Proof. Omitted, see [EGNO15, Corollary 8.14.4]. □

Example 9.45 We continue [Example 9.43](#): The S matrix and the fusion rules are stated in (the proof of) [Proposition 9.39](#), and we indeed get e.g.

$$0 = \frac{-[2]_q[3]_q^2}{[1]_q} + \frac{[4]_q[6]_q^2}{[2]_q} + \frac{-[6]_q[9]_q^2}{[3]_q}, \quad 4 = \frac{[2]_q^2[3]_q}{[1]_q} + \frac{[4]_q^2[6]_q}{[2]_q} + \frac{[6]_q^2[9]_q}{[3]_q}.$$

9J. **The modular group.** Let us explain where the name “modular” comes from. To this end, we first recall that there is the *Möbius group* given by *Möbius transformations*, i.e.

$$f: \mathbb{C} \rightarrow \mathbb{C}, \quad f(z) = \frac{az + b}{cz + d}, \quad \text{where } ad - bc \neq 0.$$

Algebraically speaking the Möbius group is

$$\text{PGL}_2(\mathbb{C}) = \left\{ A = \begin{pmatrix} a & b \\ c & d \end{pmatrix} \mid A \in \text{Mat}_{2 \times 2}(\mathbb{C}), \det(A) = ad - bc \neq 0 \right\} / (\pm 1),$$

which is the projective linear group of the Riemann sphere \mathbb{P}^1 . (Recall that “projective” in this sense should be read as “up to scalars”.) Geometrically, thinking of the Riemann sphere as the complex number plane wrapped around a sphere a Möbius transformations

This usually produces nice pictures:

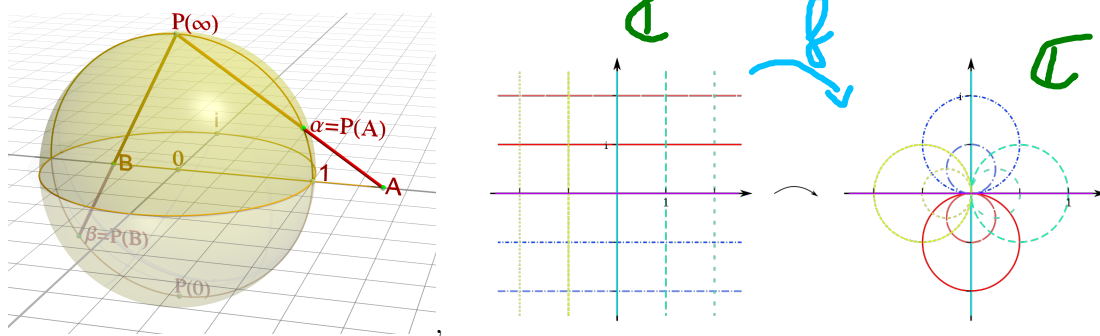

https://commons.wikimedia.org/wiki/File:Riemann_sphere.png,

<https://commons.wikimedia.org/wiki/File:MoebiusInversion.svg>.

Anyway, the “algebraic version” of the Möbius group is the modular group which, depending on the literature, is either $\text{PGL}_2(\mathbb{Z})$ or $\text{PSL}_2(\mathbb{Z})$, and is of crucial importance in e.g. number theory. For us the latter is the one we want, and in formulas:

$$\text{PSL}_2(\mathbb{Z}) = \left\{ A = \begin{pmatrix} a & b \\ c & d \end{pmatrix} \mid A \in \text{Mat}_{2 \times 2}(\mathbb{Z}), \det(A) = ad - bc = 1 \right\} / (\pm 1).$$

It is well-known that $\text{PSL}_2(\mathbb{Z})$ has a generator–relation presentation of the form

$$\text{PSL}_2(\mathbb{Z}) = \langle S, T \mid S^4 = 1, (ST)^3 = S^2 \rangle,$$

where S and T correspond to the matrices $\begin{pmatrix} 0 & -1 \\ 1 & 0 \end{pmatrix}$ and $\begin{pmatrix} 1 & 1 \\ 0 & 1 \end{pmatrix}$, respectively.

Thus, the summary of the above, in particular [Proposition 9.42](#), is:

Theorem 9.46 Let $\mathbb{C} \in \text{MoCat}$ be \mathbb{k} linear such that $\sqrt{\text{Dim}(\mathbb{C})} \in \mathbb{k}$. Then

$$\text{PSL}_2(\mathbb{Z}) \rightarrow \text{End}_{\text{fdVec}_{\mathbb{k}}}(\text{End}_{\mathbb{C}}(\mathbb{1})^n), \quad S \mapsto \frac{1}{\sqrt{\text{Dim}(\mathbb{C})}} \cdot S, T \mapsto T,$$

defines a projective action of the modular group.

Let us stress again that “projective” hereby means “up to scalars”.

Handwritten: Hopf $\rightarrow S \rightarrow S$

Handwritten: $(-1, -1)$ and $ad-bc=1$

Handwritten: \square and $T \mapsto T$

9K. **Summary of categories.** Let us summarize the categorical constructions which in the end gave us modular categories.

- “Categorifying sets” \rightsquigarrow categories \rightsquigarrow access to morphisms.
- “Categorifying monoids” \rightsquigarrow monoidal categories \rightsquigarrow access to a two dimensional calculus.
- “Categorifying dual vector spaces” \rightsquigarrow rigid, pivotal, spherical categories \rightsquigarrow access to height operations.
- “Categorifying braid groups” \rightsquigarrow braided categories \rightsquigarrow access to the Reidemeister calculus.
- “Categorifying abelian groups” \rightsquigarrow additive and abelian categories \rightsquigarrow access to linear and homological algebra.
- “Categorifying algebras” \rightsquigarrow fiat and tensor categories \rightsquigarrow access to linear and homological algebra, a two dimensional calculus and height operations.
- “Categorifying semisimple algebras” \rightsquigarrow fusion categories \rightsquigarrow access to numerical data.
- “Action of the modular group” \rightsquigarrow modular categories \rightsquigarrow access to number theoretical data.

u
=1

9L. Exercises.

Exercise 9.47 Let $l_i \in \text{End}_{\mathbf{qBr}}(\mathbb{1})$ for $i = 1, 2, 3, 4$ be the Hopf link with various orientations:

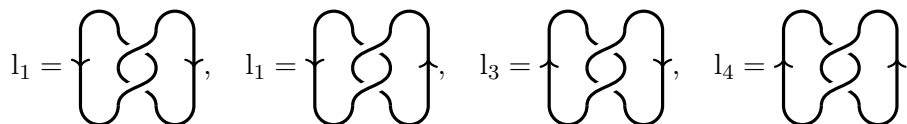

Find $f_i \in \mathbf{qSym}$ for $i = 1, 2, 3, 4$ with $A(f_i) = l_i$ (taking upwards-oriented right traces). Further, prove algebraically that the Markov moves hold after closing in \mathbf{qBr} .

Exercise 9.48 Make Remark 9.18 precise. For example, what kind of “free as an XYZ” should be satisfied by the category of colored braids?

Exercise 9.49 Let G be a finite group, and consider $\mathbf{fdMod}(\mathbb{C}[G])$ with standard braiding and duality. Show that the S matrix of $\mathbf{fdMod}(\mathbb{C}[G])$ is of rank 1. For which G can $\mathbf{fdMod}(\mathbb{C}[G])$ be modular?

Exercise 9.50 Proof Proposition 9.33.

Exercise 9.51 Verify as many claims from Section 9G as possible.

10. QUANTUM INVARIANTS – A DIAGRAMMATIC APPROACH

Recall from Section 5K that a quantum invariant is structure preserving functor from a Brauer-type category to a, say, fiat, fusion or modular category.

How to construct quantum invariants?

u
/

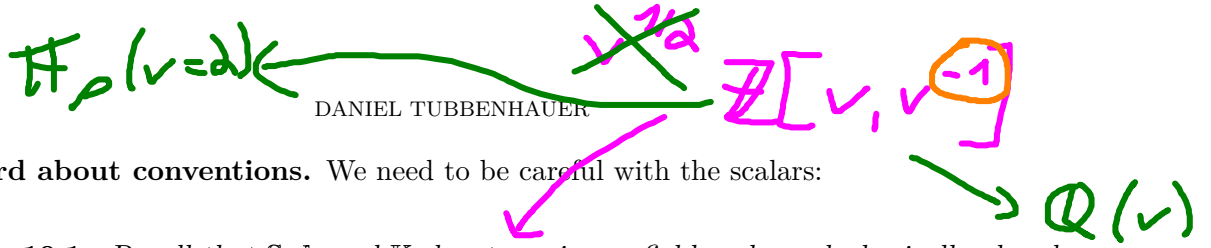

10A. **A word about conventions.** We need to be careful with the scalars:

Convention 10.1 Recall that \mathbb{S} , \mathbb{k} and \mathbb{K} denote a ring, a field and an algebraically closed field, respectively. We further need $\mathbb{A} = \mathbb{Z}[v^{1/2}, v^{-1/2}]$ for v being a formal variable (v is the generic quantum parameter, in contrast to q which will always be some specialization).

Convention 10.2 Since $q = \pm 1 \in \mathbb{S}$ will always behave differently from e.g. $q = \exp(2\pi i/l) \in \mathbb{C}$ for $l > 2$, we will not count $q = \pm 1$ as roots of unity.

10B. **An interlude about specializations.** For any pair (\mathbb{S}, q) of a ring and an element $q^{1/2} \in \mathbb{S}^*$ (we need a square root of the parameters because of the braiding, cf. (7-10)), let \mathbb{A} act on \mathbb{S} from the left via

$$\mathbb{A} \circlearrowleft \mathbb{S}, \quad 1 \cdot x = x, v \cdot x = qx,$$

which makes \mathbb{S} into a left \mathbb{A} module. We thus get a specialization functor

$$(10-1) \quad - \otimes_{\mathbb{A}}^{v=q} \mathbb{S}: \mathbf{Vec}_{\mathbb{A}} \rightarrow \mathbf{Vec}_{\mathbb{S}}, \quad X \mapsto X \otimes_{\mathbb{A}}^{v=q} \mathbb{S}.$$

In words, $- \otimes_{\mathbb{A}}^{v=q} \mathbb{S}$ extends scalars to \mathbb{S} and substitutes $v = q$. The pair (\mathbb{S}, q) is also called a **specialization**.

Let $\mathbf{C}_{\mathbb{A}} \in \mathbf{Cat}_{\mathbb{A}}$. Similarly as before, we get a **category specialized at q** , denoted by $\mathbf{C}_{\mathbb{S}}^q$, by extending scalars to \mathbb{S} and substituting $v = q$. Formally:

- First we let $\mathbf{Ob}(\mathbf{C}_{\mathbb{S}}^q) = \mathbf{Ob}(\mathbf{C}_{\mathbb{A}})$;
- then we let

$$\mathbf{Hom}_{\mathbf{C}_{\mathbb{S}}^q}(X, Y) = \mathbf{Hom}_{\mathbf{C}_{\mathbb{A}}}(X, Y) \otimes_{\mathbb{A}}^{v=q} \mathbb{S},$$

where $- \otimes_{\mathbb{A}}^{v=q} \mathbb{S}$ is as in (10-1).

$v \mapsto q$
 $q = \alpha \in \mathbb{F}_{\alpha}$

The following is easy, but crucial:

Lemma 10.3 Let $\mathbf{C}_{\mathbb{A}}$ be as above, and let (\mathbb{S}, q) any specialization. If B is a basis of $\mathbf{Hom}_{\mathbf{C}_{\mathbb{A}}}(X, Y)$, then it is also a basis of $\mathbf{Hom}_{\mathbf{C}_{\mathbb{S}}^q}(X, Y)$. \square

We have a few different looking cases which however will behave grouped as follows.

(I) The **integral case** which is either of:

- We stay with \mathbb{A} .
- We let $\mathbb{S} = \mathbb{Z}$ and $q = \pm 1$.

$\mathbb{S} = \mathbb{Z} \quad q = \pm 1$

(II) The **generic case** (or **generically**) which is either of:

- $\mathbb{S} = \mathbb{k}$ being a field of characteristic zero and $q = \pm 1$.
- We let $\mathbb{S} = \mathbb{k}$ be any field and $q \neq \pm 1$ not a root of unity in \mathbb{k} .

$q \rightsquigarrow \text{formal}$

(III) The **finite characteristic case** (or **char p case**) where $\mathbb{S} = \mathbb{k}$ is a field of characteristic $p > 0$ and $q = \pm 1$.

$q = \pm 1 \rightsquigarrow \mathbb{S} = 0 \text{ in } \mathbb{F}_p$

- (IV) The complex root of unity case where $\mathbb{S} = \mathbb{k}$ is a field of characteristic $p = 0$ and $q \in \mathbb{k}$ is a root of unity such that q^2 is of order l .
- (V) The mixed root of unity case (or mixed case) where $\mathbb{S} = \mathbb{k}$ is a field of characteristic $p > 0$ and $q \in \mathbb{k}$ is a root of unity such that q^2 is of order l .

Example 10.4 *It is a bit confusing, so let us make clear that the generic case includes the choice $\mathbb{S} = \mathbb{C}(q)$, for a formal variable q , which is probably the most common ground field in quantum topology and quantum algebra.*

$$\mathbb{S} = \mathbb{C}(q) \quad v \mapsto q$$

The philosophy is that we have a category \mathbf{C}_A , defined integrally, with an integral basis and integral objects ("objects which are always defined"), whose decomposition however depend on the specialization: Usually \mathbf{C}_A has pseudo idempotents, i.e. morphisms with

$$\left(\frac{e}{a}\right)^2 = \frac{e}{a}$$

$$e^2 = a \cdot e, \quad a \in \mathbb{A}$$

$$e^2 = a \cdot e \quad \leftarrow a \in \mathbb{A} \rightarrow \text{EV of } e$$

As we have already seen in [Section 7B](#), idempotents are very important to understand categories at hand, and they should decompose the integral objects into indecomposables. So we want to divide by a to get an idempotent:

$$(e^2 = a \cdot e) \Rightarrow \left(\frac{1}{a}e\right)^2 = \frac{1}{a}e.$$

So the crucial fact we need is whether the scalar a is invertible, which depends on the choice of specialization. Here is a prototypical example:

Example 10.5 *Let us come back to the symmetric group S_3 and let us consider the integral case $\mathbb{Z}[S_3]$ and its category $\mathbf{C}_{\mathbb{Z}}^1 = \mathbf{fdMod}(\mathbb{Z}[S_3])$. In this case an integral object would be $\mathbb{Z}[S_3]$ itself, which we can always define.*

We already know that generically $\mathbf{C}_{\mathbb{S}}^1$ is semisimple, e.g. for $\mathbb{S} = \mathbb{C}$ we have

$$(10-2) \quad \mathbb{C}[S_3] \cong \mathbb{1} \oplus 2 \cdot L_s \oplus L_{-1},$$

see [Example 8.15](#). However, for $\mathbb{S} = \overline{\mathbb{F}}_2$ or $\mathbb{S} = \overline{\mathbb{F}}_3$ this is not the case anymore, see [Example 8.29](#), and one can see this in $\mathbf{fdMod}(\mathbb{Z}[S_3])$ as follows.

Let $S_3 = \{1, s, t, ts, st, sts = tst\}$, where, in graphical notation,

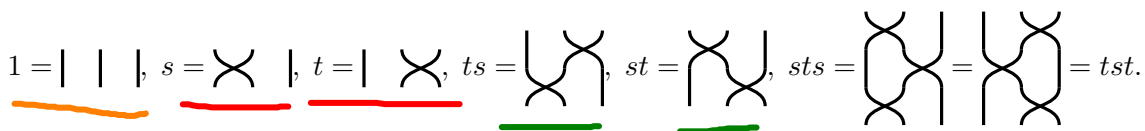

The category $\mathbf{fdMod}(\mathbb{Z}[S_3])$ has the following four pseudo idempotents:

$$\begin{aligned}
 e_1 &= 1 + s + t + ts + st + sts, & e_1^2 &= 6 \cdot e_1, \\
 e_{s,1} &= 1 + s - ts - sts, & e_{s,1}^2 &= 3 \cdot e_{s,1}, \\
 e_{s,2} &= 1 - s - st + sts, & e_{s,2}^2 &= 3 \cdot e_{s,2}, \\
 e_{-1} &= 1 - s - t + ts + st - sts, & e_{-1}^2 &= 6 \cdot e_{-1},
 \end{aligned}$$

orthogonal: $xy = 0$, where $x, y \in \{e_1, e_{s,1}, e_{s,2}, e_{-1}\}, x \neq y$,
 pseudo complete: $e_1 + 2e_{s,1} + 2e_{s,2} + e_{-1} = 6$.

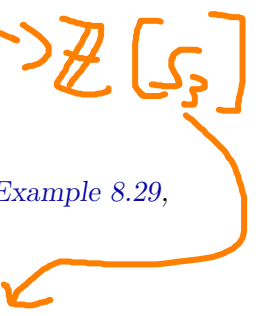



We recover the three different cases we were already aware of: In \mathbb{C} we can scale them to be idempotents and we get the decomposition (10-2). For $\mathbb{S} = \overline{\mathbb{F}}_2$ we can scale the middle two pseudo idempotents to get idempotents, while for $\mathbb{S} = \overline{\mathbb{F}}_3$ no scaling works.

Note that integrally we can not decompose $\mathbb{Z}[\mathbb{S}_3]$. In fact, we get a decomposition into indecomposables depending on the specialization: the generic case is (10-2), while

$$\overline{\mathbb{F}}_2[\mathbb{S}_3] \cong \mathbb{P}_1 \oplus \mathbb{P}_s, \quad \overline{\mathbb{F}}_3[\mathbb{S}_3] \cong \mathbb{P}_1 \oplus \mathbb{P}_{1'}$$

are the decompositions in characteristic 2 and 3, respectively.



The plan of this section is to discuss this strategy for the Rumer-Teller-Weyl category, which will ultimately lead to the construction of the Verlinde categories (for Sl_2) and Jones-type invariants.

10C. **An integral basis for the Rumer-Teller-Weyl category.** Let $\mathbf{TL}_{\mathbb{A}}^v$ denote the category as defined in Definition 7.39, but over the ground ring \mathbb{A} and without taking additive and idempotent closures (for the time being). Recall that $\mathbf{TL}_{\mathbb{A}}^v$ is a \mathbb{A} linear ribbon category.

We further let $E = \mathbb{R}$, $E^+ = \mathbb{R}_{\geq 0}$, $X = \mathbb{Z} \subset E$ and $X^+ = \mathbb{N} \subset E$. We also let $\Phi = \{\varepsilon_1 = 1, \varepsilon_{-1} = -1\} \subset E$.

$$0 = -v - v^{-1}$$

Definition 10.6 A (n integral) **path** π of length k in E is a word $\pi = \pi_1 \dots \pi_k \in \Phi^k$ of length k . Such a path is called **non-negative** if $\sum_{i=1}^j \pi_i \in X^+$ for all $1 \leq j \leq k$.

Definition 10.7 The **weight** of a path π is $\lambda(\pi) = \sum_{i=1}^k \pi_i \in X$.

Example 10.8 We think of paths as “honest” paths in E , starting at 0, using the rules

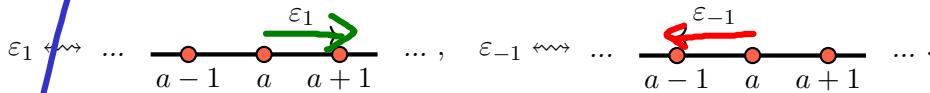

Using this interpretation, a path is non-negative if and only if it stays in E^+ , and the weight is its endpoint in E^+ . For example,

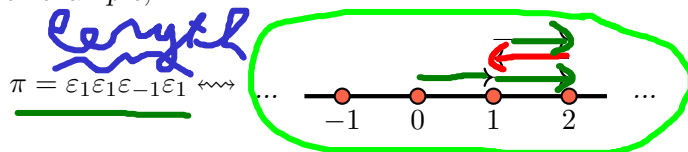

is a non-negative path of length four and weight two. Note also that having a non-negative weight, a.k.a. endpoint, is not enough to be a non-negative path, e.g. the following is not a non-negative path, but has non-negative weight:

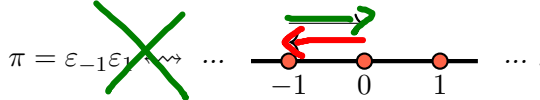

Definition 10.9 To $\varepsilon_{\pm 1}$ we associate operators via:

$$(10-3) \quad \varepsilon_1(f): \boxed{f} \mapsto \boxed{f} \mid, \quad \varepsilon_{-1}(f): \boxed{f} \mapsto \boxed{f} \cap$$

In words, if we already have a morphism $f \in \mathbf{TL}_{\mathbb{A}}^v$, then we obtain to new morphism $f\varepsilon_{\pm 1} \in \mathbf{TL}_{\mathbb{A}}^v$ by either adding a strand or a cap to the right.

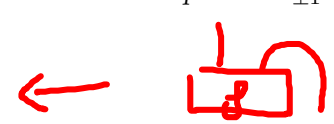

Definition 10.10 The downward integral ladder $d(\pi) \in \mathbf{TL}_{\mathbb{A}}^v$ associated to a non-negative path π is the morphism $\pi(\text{id}_{\emptyset})$ obtained by successively using (10-3). The upward integral ladder $u(\pi) \in \mathbf{TL}_{\mathbb{A}}^v$ is the corresponding downward integral ladder horizontally mirrored.

By vertical mirroring it suffices to only calculate down integral ladder, of course, e.g.

$$d(\pi) = \text{diagram} \Leftrightarrow u(\pi) = \text{diagram}$$

Example 10.11 One can easily check that

$$\begin{aligned} \lambda = 4: & \quad \pi_1 = \varepsilon_1 \varepsilon_1 \varepsilon_1 \varepsilon_1, \\ \lambda = 2: & \quad \pi_2 = \varepsilon_1 \varepsilon_{-1} \varepsilon_1 \varepsilon_1, \quad \pi_3 = \varepsilon_1 \varepsilon_1 \varepsilon_{-1} \varepsilon_1, \quad \pi_4 = \varepsilon_1 \varepsilon_1 \varepsilon_1 \varepsilon_{-1}, \\ \lambda = 0: & \quad \pi_5 = \varepsilon_1 \varepsilon_{-1} \varepsilon_1 \varepsilon_{-1}, \quad \pi_6 = \varepsilon_1 \varepsilon_1 \varepsilon_{-1} \varepsilon_{-1}, \end{aligned}$$

are the only non-negative paths of length four. We get:

$$\begin{aligned} \lambda = 4: & \quad d(\pi_1) = \text{diagram} \\ \lambda = 2: & \quad d(\pi_2) = \text{diagram}, \quad d(\pi_3) = \text{diagram}, \quad d(\pi_4) = \text{diagram}, \\ \lambda = 0: & \quad d(\pi_5) = \text{diagram}, \quad d(\pi_6) = \text{diagram} \end{aligned}$$

Moreover, we denote by $(\lambda, \pi_d^m, \pi_u^n)$ a triple of a weight λ , and two non-negative paths π_d^m and π_u^n of this weight, of length as indicated by the superscripts.

Definition 10.12 The integral ladder associated to the triple $(\lambda, \pi_d^m, \pi_u^n)$ is the morphism

$$c_{\pi_u^n, \pi_d^m}^\lambda = u(\pi_u^n) d(\pi_d^m) \in \text{Hom}_{\mathbf{TL}_{\mathbb{A}}^v}(\bullet^m, \bullet^n).$$

We also write $c_{u,d}^\lambda = c_{\pi_u^n, \pi_d^m}^\lambda$ etc. for simplicity of notation.



Example 10.13 With respect to Example 10.11: the integral ladders which can be obtained from the diagrams therein are 14 in total:

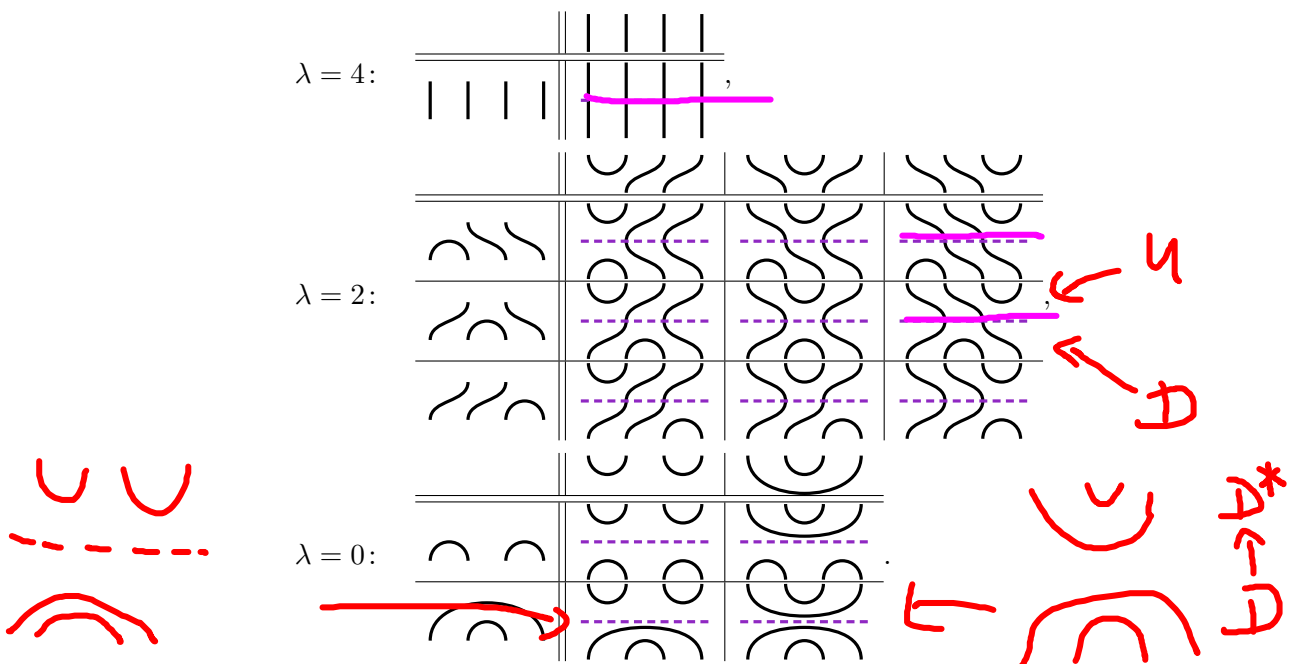

Note that the weight λ can be read off in the middle, as indicated.

Example 10.14 In Example 10.13 we have calculated integral ladder morphisms in $\text{End}_{\mathbf{TL}_{\mathbb{A}}^v}(\bullet^4)$. For, say $\text{Hom}_{\mathbf{TL}_{\mathbb{A}}^v}(\bullet^2, \bullet^4)$ we first observe that we have only two non-negative paths of length 2, and thus, also only two downwards integral ladders:

$$\pi_1 = \varepsilon_1 \varepsilon_1 \longleftrightarrow \begin{array}{|c|} \hline | \\ \hline \end{array}, \quad \pi_2 = \varepsilon_1 \varepsilon_{-1} \longleftrightarrow \begin{array}{|c|} \hline \cup \\ \hline \end{array}.$$

Thus, we get the following integral ladders in $\text{Hom}_{\mathbf{TL}_{\mathbb{A}}^v}(\bullet^2, \bullet^4)$:

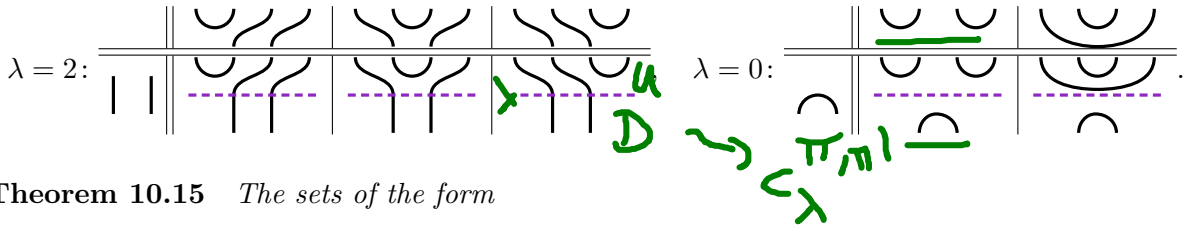

Theorem 10.15 The sets of the form

$$(10-4) \quad \text{IL} = \{c_{\pi_u^n, \pi_d^m}^\lambda \mid \lambda \text{ a weight, } \pi_u^n, \pi_d^m \text{ non-negative paths}\}$$

are bases of $\text{Hom}_{\mathbf{TL}_{\mathbb{A}}^v}(\bullet^m, \bullet^n)$.

A \rightsquigarrow gives a basis for any \mathcal{S}

Proof. In this formulation the crucial observation is [El15, Theorem 2.57], showing linear independence. That integral ladders span follows by observing that $\text{Hom}_{\mathbf{TL}_{\mathbb{A}}^v}(\bullet^m, \mathbb{1})$ is clearly spanned by integral ladders (“crossingless matchings”), which implies the claim since mating preserves this property, see Theorem 4.16. \square

We call IL as in (10-4) the integral ladder basis of $\mathbf{TL}_{\mathbb{A}}^v$. Note that this basis is built using a *bottleneck principle*, and we will also illustrate the basis elements by

$$(10-5) \quad c_{u,d}^\lambda = \begin{array}{|c|} \hline u \\ \hline d \\ \hline \end{array} \lambda = \begin{array}{|c|} \hline u \\ \hline d \\ \hline \end{array}.$$

Denote by $\mathbf{I}_{<i}$ the set of morphisms in $\mathbf{TL}_{\mathbb{A}}^v$ which contain at most $i - 1$ through strands, e.g.

$$\begin{array}{|c|} \hline \cup \\ \hline \end{array} \in \mathbf{I}_{<2}, \quad \begin{array}{|c|} \hline \cup \\ \hline \cup \\ \hline \end{array} \notin \mathbf{I}_{<1}.$$

Clearly, $\mathbf{I}_{<j} \subset \mathbf{I}_{<i}$ if $j \leq i$. Moreover:

Lemma 10.16 The set $\mathbf{I}_{<i}$ is an ideal in $\mathbf{TL}_{\mathbb{A}}^v$, i.e.

$$(f \in \mathbf{I}_{<i}, g, h \in \mathbf{TL}_{\mathbb{A}}^v) \Rightarrow (gf, fh \in \mathbf{I}_{<i}).$$

Proof. This is Exercise 10.51. \square

The point is that these “get thinner if we multiply”:

Lemma 10.17 We have

$$\begin{array}{|c|} \hline u' \\ \hline d' \\ \hline u \\ \hline d \\ \hline \end{array} \mu = a \cdot \begin{array}{|c|} \hline u'' \\ \hline d \\ \hline \end{array} + \mathbf{I}_{<\lambda} = b \cdot \begin{array}{|c|} \hline u \\ \hline d'' \\ \hline \end{array} \mu + \mathbf{I}_{<\mu},$$

where the scalars $a = a(u, d')$, $b = b(u, d') \in \mathbb{A}^\infty$ only depend on u and d' .

Proof. The integral basis is constructed to get “thinner”. Details are supposed to be done in Exercise 10.53. \square

Example 10.18 With the notation as in Example 10.11 we have e.g.

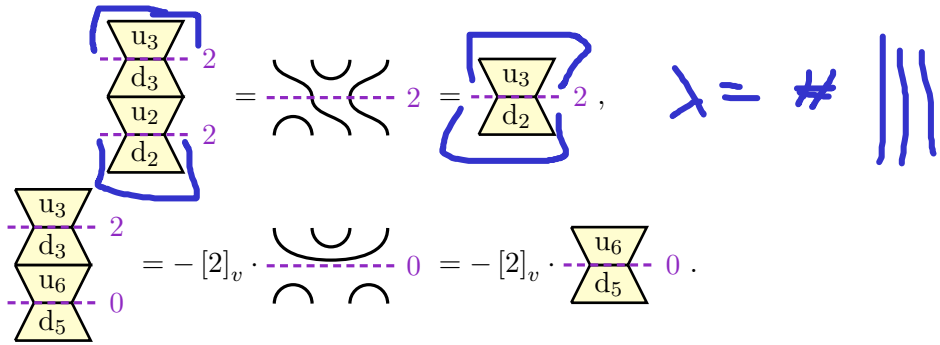

10D. Jones–Wenzl idempotents and their generalizations. Recall the quantum numbers as in (9-13). (We will use different subscripts to make it clear whether we work in a specialization or not.) We also need the *quantum binomials* for $a \in \mathbb{Z}$ and $b \in \mathbb{N}$. First, by convention, $\begin{bmatrix} a \\ 0 \end{bmatrix}_v = 1$ and otherwise we let

$$\begin{bmatrix} a \\ b \end{bmatrix}_v = \frac{[a]_v [a-1]_v \dots [a-b+1]_v}{[b]_v [b-1]_v \dots [1]_v} \in \mathbb{A}. \quad v=1 \rightsquigarrow \binom{a}{b}$$

(Note that these are elements of \mathbb{A} , as one can check.) Of course, for $q = 1$ the quantum binomial is the usual binomial and for $q = -1$ it is a signed version of the usual binomial. Moreover,

$$\begin{bmatrix} a \\ b \end{bmatrix}_v = 0 \Leftrightarrow a < b,$$

which is however far from being true in specializations.

Example 10.19 Here are some explicit examples for specializations with $p = \text{char}(\mathbb{S})$:

	$\begin{bmatrix} 8 \\ 0 \end{bmatrix}_q$	$\begin{bmatrix} 8 \\ 1 \end{bmatrix}_q$	$\begin{bmatrix} 8 \\ 2 \end{bmatrix}_q$	$\begin{bmatrix} 8 \\ 3 \end{bmatrix}_q$	$\begin{bmatrix} 8 \\ 4 \end{bmatrix}_q$	$\begin{bmatrix} 8 \\ 5 \end{bmatrix}_q$	$\begin{bmatrix} 8 \\ 6 \end{bmatrix}_q$	$\begin{bmatrix} 8 \\ 7 \end{bmatrix}_q$	$\begin{bmatrix} 8 \\ 8 \end{bmatrix}_q$
$q = 1, p = 0$	1	8	28	56	70	56	28	8	1
$q = -1, p = 0$	1	-8	28	-56	70	-56	28	-8	1
$q = 2, p = 0$	1	$\frac{21845}{128}$	$\frac{23859109}{4096}$	$\frac{1550842085}{32768}$	$\frac{6221613541}{65536}$	$\frac{1550842085}{32768}$	$\frac{23859109}{4096}$	$\frac{21845}{128}$	1
$q = 1, p = 3$	1	2	1	2	1	2	1	2	1
$q = 1, p = 5$	1	3	3	1	0	1	3	3	1
$q = 1, p = 7$	1	1	0	0	0	0	0	1	1
$q = \exp(2\pi i/3), p = 0$	1	-1	1	2	-2	2	1	-1	1
$q = \exp(2\pi i/5), p = 0$	1	$\frac{1}{2}(1 - \sqrt{5})$	$\frac{1}{2}(1 - \sqrt{5})$	1	0	1	$\frac{1}{2}(1 - \sqrt{5})$	$\frac{1}{2}(1 - \sqrt{5})$	1
$q = \exp(2\pi i/7), p = 0$	1	1	0	0	0	0	0	1	1
$q = 2, p = 13$	1	4	1	0	0	0	1	4	1
$q = 3, p = 13$	1	12	1	2	11	2	1	12	1
$q = 4, p = 13$	1	1	1	11	11	11	1	1	1

(Note that the appearing of fractions in the $q = 2$ and $p = 0$ case above is not a contradiction to the claim that $\begin{bmatrix} a \\ b \end{bmatrix}_v \in \mathbb{A}$ since $2^{-k} \in \mathbb{A} \otimes_{\mathbb{A}}^{v=2} \mathbb{S}$.) Let us do two more examples. First $a = 11$:

	$\begin{bmatrix} 11 \\ 0 \end{bmatrix}_q$	$\begin{bmatrix} 11 \\ 1 \end{bmatrix}_q$	$\begin{bmatrix} 11 \\ 2 \end{bmatrix}_q$	$\begin{bmatrix} 11 \\ 3 \end{bmatrix}_q$	$\begin{bmatrix} 11 \\ 4 \end{bmatrix}_q$	$\begin{bmatrix} 11 \\ 5 \end{bmatrix}_q$	$\begin{bmatrix} 11 \\ 6 \end{bmatrix}_q$	$\begin{bmatrix} 11 \\ 7 \end{bmatrix}_q$	$\begin{bmatrix} 11 \\ 8 \end{bmatrix}_q$	$\begin{bmatrix} 11 \\ 9 \end{bmatrix}_q$	$\begin{bmatrix} 11 \\ 10 \end{bmatrix}_q$	$\begin{bmatrix} 11 \\ 11 \end{bmatrix}_q$
$q = 1, p = 3$	1	2	1	0	0	0	0	0	0	1	2	1
$q = \exp(2\pi i/3), p = 0$	1	-1	1	3	-3	3	3	-3	3	1	-1	1

And finally, $a = 14$:

	$\begin{bmatrix} 14 \\ 0 \end{bmatrix}_q$	$\begin{bmatrix} 14 \\ 1 \end{bmatrix}_q$	$\begin{bmatrix} 14 \\ 2 \end{bmatrix}_q$	$\begin{bmatrix} 14 \\ 3 \end{bmatrix}_q$	$\begin{bmatrix} 14 \\ 4 \end{bmatrix}_q$	$\begin{bmatrix} 14 \\ 5 \end{bmatrix}_q$	$\begin{bmatrix} 14 \\ 6 \end{bmatrix}_q$	$\begin{bmatrix} 14 \\ 7 \end{bmatrix}_q$	$\begin{bmatrix} 14 \\ 8 \end{bmatrix}_q$	$\begin{bmatrix} 14 \\ 9 \end{bmatrix}_q$	$\begin{bmatrix} 14 \\ 10 \end{bmatrix}_q$	$\begin{bmatrix} 14 \\ 11 \end{bmatrix}_q$	$\begin{bmatrix} 14 \\ 12 \end{bmatrix}_q$	$\begin{bmatrix} 14 \\ 13 \end{bmatrix}_q$	$\begin{bmatrix} 14 \\ 14 \end{bmatrix}_q$
$q = 1, p = 7$	1	0	0	0	0	0	2	0	0	0	0	0	0	0	1
$q = \exp(2\pi i/3), p = 0$	1	-1	1	4	-4	4	6	-6	6	4	-4	4	1	-1	1
$q = 2, p = 7$	1	6	1	4	3	4	6	1	6	4	3	4	1	6	1

For $i \in \mathbb{N}$ let us use the ground ring

$$\mathbb{A}^i = \mathbb{A} \left[\left(\begin{bmatrix} i \\ j \end{bmatrix}_v \right)^{-1} \mid 0 \leq j \leq i \right]$$

obtained from \mathbb{A} by formally inverting the quantum binomials. Now we come back to [Definition 10.20](#):

Definition 10.20 For $i \in \mathbb{N}$ an i th Jones–Wenzl idempotent (JW idempotent for short) $e_i \in \text{End}_{\mathbf{TL}_{\mathbb{A}^i \oplus}}(\bullet^i)$, denoted by,

$$e_i = \boxed{e_i} = \begin{array}{c} \bullet \\ \vdots \\ \boxed{e_i} \\ \vdots \\ \bullet \end{array} \in \text{End}_{\mathbf{TL}_{\mathbb{A}^i \oplus}}(\bullet^i)$$

is a morphism satisfying:

- it is an idempotent, i.e.

$$(10-6) \quad e_i^2 = e_i \iff \begin{array}{c} \boxed{e_i} \\ \boxed{e_i} \end{array} = \boxed{e_i};$$

- it annihilates caps and cups, i.e.

$$(10-7) \quad \mathbf{I}_{<i} e_i = 0 = e_i \mathbf{I}_{<i} \iff \begin{array}{c} \text{cap} \\ \boxed{e_i} \end{array} = 0 = \begin{array}{c} \boxed{e_i} \\ \text{cup} \end{array};$$

- it contains the identity with coefficient 1, i.e.

$$(10-8) \quad (\text{id}_{\bullet^i} - e_i) \in \mathbf{I}_{<i} \iff \boxed{e_i} = \left| \dots \right| + \text{diagrams with caps and cups.}$$

The following is just some algebraic yoga and the crucial point will be the existence of JW idempotents.

Lemma 10.21 If an i th JW idempotent exists, then it is unique.

Proof. If e_i and e'_i are two such idempotents, then (10-8) implies that $e_i - e'_i \in \mathbf{I}_{<i}$. Thus, using the other two defining properties we calculate

$$e_i - e_i e'_i \stackrel{(10-6)}{=} e_i(e_i - e'_i) \stackrel{(10-7)}{=} 0 \stackrel{(10-7)}{=} (e_i - e'_i)e'_i \stackrel{(10-6)}{=} e'_i - e_i e'_i,$$

which shows the claim. □

Thus, we will say **the** i th JW idempotent.

Proposition 10.22 The i th JW idempotent exists in $\mathbf{TL}_{\mathbb{A}^i}^v$

Proof. We do not know a self-contained proof (i.e. using the combinatorics of $\mathbf{TL}_{\mathbb{A}^i}^v$ only) of this fact and refer to [EL17, Theorem A.2]. □

Remark 10.23 As we have seen e.g. in [Example 10.5](#), idempotents tend to have longish expressions. Then same is true for the JW idempotents, see [Definition 9.35](#) for e_2 and e_3 , and the philosophy here would be not to expand them using the recursion from (10-12) below, but rather the abstract properties.

Lemma 10.24 *JW idempotents satisfy the following.*

(i) We have hom vanishing, i.e. for $0 \leq j \leq i$ we have

$$(10-9) \quad e_j \text{Hom}_{\text{TL}_{\mathbb{A}^i \oplus}}(\bullet^i, \bullet^j) e_i = \begin{cases} \mathbb{A}^i \{e_i\} & \text{if } \underline{i=j}, \\ 0 & \text{else.} \end{cases}$$

Similarly if $j \geq i$.

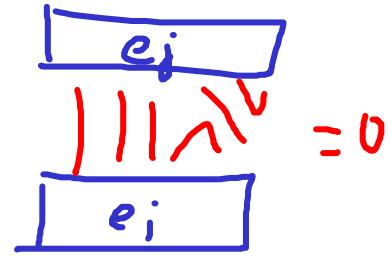

(ii) We have absorption, i.e.

$$(10-10) \quad \begin{array}{|c|} \hline e_j \\ \hline e_i \\ \hline \end{array} = e_i = \begin{array}{|c|} \hline e_i \\ \hline e_j \\ \hline \end{array} \quad \text{where } 0 \leq j \leq i.$$

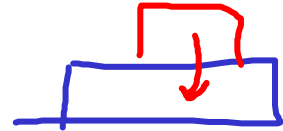

(iii) We have partial trace properties, i.e.

$$(10-11) \quad \begin{array}{|c|} \hline e_i \\ \hline \end{array} = -\frac{[i+1]_v}{[i]_v} \cdot \begin{array}{|c|} \hline e_{i-1} \\ \hline \end{array}.$$

(iv) The i th JW idempotent satisfies a recursion: First, we have

$$e_0 = \emptyset, \quad e_1 = \begin{array}{|c|} \hline \\ \hline \end{array}.$$

Then, for $i \geq 2$, we have

$$(10-12) \quad e_i = e_{i-1} \begin{array}{|c|} \hline e_{i-1} \\ \hline e_{i-2} \\ \hline e_{i-1} \\ \hline \end{array}.$$

Proof. (i). Immediate from the definitions.

(ii). To prove absorption we simply observe that $e_j = \text{id}_{\bullet^j} + \mathbf{I}_{<j}$, and recall that e_i annihilates caps and cups (10-7).

(iii)+(iv). We prove these two claims inductively in tandem. For $i = 0$ or $i = 1$ both claims are clear, so let us suppose that $i \geq 2$ and that (iii) and (iv) hold for all $j < i$. Then define a morphism e'_i by (10-12). Having this expression it is easy to see inductively that the defining properties of an i th JW idempotent hold: (10-8) is clear, while for (10-7) the crucial calculation is

$$\begin{array}{|c|} \hline e_{i-1} \\ \hline \end{array} + \frac{[i-1]_v}{[i]_v} \cdot \begin{array}{|c|} \hline e_{i-1} \\ \hline e_{i-2} \\ \hline e_{i-1} \\ \hline \end{array} \stackrel{(10-11)}{=} \begin{array}{|c|} \hline e_{i-1} \\ \hline \end{array} - \begin{array}{|c|} \hline e_{i-2} \\ \hline e_{i-2} \\ \hline e_{i-1} \\ \hline \end{array} \stackrel{(10-10)}{=} \begin{array}{|c|} \hline e_{i-1} \\ \hline \end{array} - \begin{array}{|c|} \hline e_{i-1} \\ \hline \end{array} = 0.$$

The same calculations shows (10-6). For partial traces we calculate

$$\begin{array}{|c|} \hline e_{i-1} \\ \hline \end{array} + \frac{[i-1]_v}{[i]_v} \cdot \begin{array}{|c|} \hline e_{i-1} \\ \hline e_{i-2} \\ \hline e_{i-1} \\ \hline \end{array} \stackrel{(10-10)}{=} (-[2]_v + \frac{[i-1]_v}{[i]_v}) \cdot \begin{array}{|c|} \hline e_{i-1} \\ \hline \end{array} = -\frac{[i+1]_v}{[i]_v} \cdot \begin{array}{|c|} \hline e_{i-1} \\ \hline \end{array}.$$

This shows the lemma. □

Lemma 10.25 *For the canonical pivotal structure we have $\text{tr}^{\text{TL}_v^i}(e_i) = (-1)^i [i+1]_v$.*

Proof. This is Exercise 10.53. □

We can also construct a basis using the JW idempotents, which should be compared to the construction of the integral basis from Section 10C (e.g. compare (10-3) and (10-13)). To this end, let us consider the generic ground ring, inverting all quantum binomials,

$$\mathbb{A}^g = \mathbb{A} \left[\left(\binom{i}{j}_v \right)^{-1} \mid 0 \leq j \leq i, i \in \mathbb{N} \right],$$

or variations such as $\mathbb{A}^{\leq i}$, having the evident meaning.

Definition 10.26 To $\varepsilon_{\pm 1}$ we associate operators via:

$$(10-13) \quad \tilde{\varepsilon}_1(f) : \text{f} \mapsto \begin{array}{c} \boxed{e_i} \\ \text{f} \end{array}, \quad \tilde{\varepsilon}_{-1}(f) : \text{f} \mapsto \begin{array}{c} \boxed{e_{i-2}} \\ \text{f} \end{array}.$$

In words, if we already have a morphism $f \in \mathbf{TL}_{\mathbb{A}^{\leq i}}^v$ ending in \bullet^{i-1} , then we obtain to new morphism $f\varepsilon_{\pm 1} \in \mathbf{TL}_{\mathbb{A}^{\leq i}}^v$ by either adding a strand or a cap and a JW idempotent.

Copying Section 10C, we obtain *downward* $\tilde{d}(\pi) \in \mathbf{TL}_{\mathbb{A}^{\leq i}}^v$ and *upward Weyl ladders* $\tilde{u}(\pi) \in \mathbf{TL}_{\mathbb{A}^{\leq i}}^v$, respectively, and also *Weyl ladders*

$$\tilde{c}_{\pi_u^n, \pi_d^m}^\lambda = \tilde{u}(\pi_u^n) \tilde{d}(\pi_d^m) \in \text{Hom}_{\mathbf{TL}_{\mathbb{A}^{\leq i}}^v}(\bullet^m, \bullet^n), \quad i = \max\{m, n\},$$

all of which have an associated length etc. Not surprisingly, and directly from Proposition 10.22:

Proposition 10.27 The morphisms $\tilde{c}_{\pi_u^n, \pi_d^m}^\lambda$ exist in $\mathbf{TL}_{\mathbb{A}^{\leq i}}^v$ for $i = \max\{m, n\}$. □

Example 10.28 Consider the case of the all non-negative paths $\pi = \varepsilon_1 \dots \varepsilon_1$. Then absorption (10-10) gives inductively

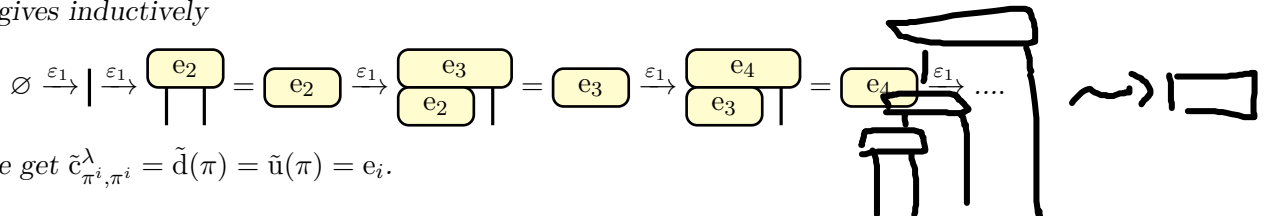

Thus, we get $\tilde{c}_{\pi^i, \pi^i}^\lambda = \tilde{d}(\pi) = \tilde{u}(\pi) = e_i$.

Example 10.29 Let us consider the analog of Example 10.11, using the same notation. After using absorption we get

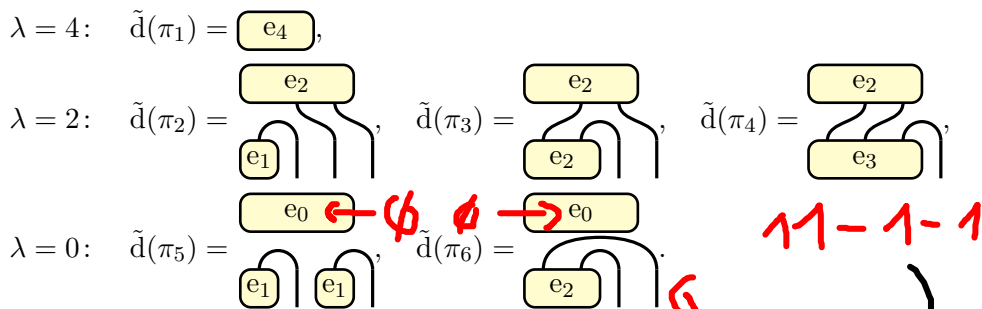

(Of course, the JW idempotents e_0 and e_1 are rather trivial and they are only illustrated to clarify the construction.)

Theorem 10.30 The sets of the form

$$(10-14) \quad \text{WL} = \{ \tilde{c}_{\pi_u^n, \pi_d^m}^\lambda \mid \lambda \text{ a weight, } \pi_u^n, \pi_d^m \text{ non-negative paths} \}$$

are bases of $\text{Hom}_{\mathbf{TL}_{\mathbb{A}^g}^v}(\bullet^m, \bullet^n)$.



1-1-1



Proof. This is (almost) immediate from [Theorem 10.15](#): Substituting the identity in the coupons of the JW idempotents recovers the integral basis IL. By (10-8) we thus get an upper triangular change-of-basis matrix between IL and WL. \square

Again, we also write e.g. $\tilde{c}_{\tilde{u},\tilde{d}}^\lambda = \tilde{c}_{\pi_u, \pi_d}^\lambda$ for simplicity. Moreover, note that these morphisms are constructed using the bottleneck principle as in (10-5) and we will illustrate these by

$$\tilde{c}_{\tilde{u},\tilde{d}}^\lambda = \text{---} \begin{array}{c} \tilde{u} \\ \tilde{d} \end{array} \text{---} \lambda = \begin{array}{c} \tilde{u} \\ \tilde{d} \end{array} \text{---}$$

Lemma 10.31 *We have*

$$\begin{array}{c} \tilde{u}' \\ \tilde{d}' \\ \tilde{u} \\ \tilde{d} \end{array} \begin{array}{c} \mu \\ \lambda \end{array} = a \cdot \begin{array}{c} \tilde{u}'' \\ \tilde{d} \end{array} \lambda + \mathbf{I}_{<\lambda} = b \cdot \begin{array}{c} \tilde{u} \\ \tilde{d}'' \end{array} \mu + \mathbf{I}_{<\mu},$$



where the scalars $a = a(\tilde{u}, \tilde{d}'), b = b(\tilde{u}, \tilde{d}') \in \mathbb{A}^\infty$ only depend on \tilde{u} and \tilde{d}' .

Proof. This follows using the abstract properties of the JW idempotents. \square

Definition 10.32 For (λ, π, π) consisting of a weight and a non-negative path, we define the (generalized) JW idempotent e_π by

$$e_\pi = \boxed{e_\pi} = \kappa_\pi^{-1} \cdot \begin{array}{c} \tilde{u} \\ \tilde{d} \end{array}, \quad \text{the scalar is defined by } \begin{array}{c} e_\lambda \\ \tilde{d} \\ \tilde{u} \\ e_\lambda \end{array} = \kappa_\pi \cdot \boxed{e_\lambda},$$

length π

where \tilde{d} and \tilde{u} are the downwards and upwards Weyl ladders associated to π .

Example 10.33 Let us calculate $\kappa_{\pi_3}^{-1}$ for $\pi_3 = \varepsilon_1 \varepsilon_1 \varepsilon_{-1} \varepsilon_1$, which uses the partial traces (10-11):

$$\begin{array}{c} \boxed{e_2} \\ \text{---} \\ \boxed{e_2} \\ \text{---} \\ \boxed{e_2} \end{array} = -\frac{[3]_v}{[2]_v} \cdot \boxed{e_2} \Rightarrow \kappa_{\pi_3}^{-1} = -\frac{[2]_v}{[3]_v}$$

Theorem 10.34 *The generalized JW idempotents are well-defined and the set*

$$\left\{ \boxed{e_\pi} \mid \pi \text{ non-negative path of length } i \right\} \subset \text{End}_{\mathbf{TL}_{\mathbb{A}^\infty}^v}(\bullet^i)$$

is a complete set of orthogonal idempotents, i.e.

$$\sum_\pi \boxed{e_\pi} = \mathbf{1}, \quad \begin{array}{c} \boxed{e_{\pi'}} \\ \boxed{e_\pi} \end{array} = \delta_{\pi, \pi'} \cdot \boxed{e_\pi}$$

Proof. Note first that the scalar κ_π exists by hom vanishing (10-9). Moreover, it is easy to see that the scalar κ_π is an iterative product of partial trace scalars, thus, can be inverted in \mathbb{A}^∞ .

That the generalized JW idempotents are orthogonal idempotents follows from the observation that

$$(10-15) \quad e_\pi = \kappa_\pi^{-1} \cdot \begin{array}{c} \tilde{u} \\ \hline \tilde{d} \end{array} = \kappa_\pi^{-1} \cdot \begin{array}{c} \tilde{u} \\ \hline e_\lambda \\ \hline \tilde{d} \end{array},$$

where λ is the weight of π , and the properties of the JW idempotents. Finally, we have

$$(10-16) \quad e_\pi \mid = e_{\pi\varepsilon_1} + e_{\pi\varepsilon_{-1}}$$

as a consequence of the JW recursion (10-12), which inductively implies that $\sum_\pi e_\pi = \text{id}_{\bullet^i}$. \square

10E. The Rumer–Teller–Weyl category – algebra. Let us further analyze the category $\mathbf{TL}_\mathbb{A}^v$ or specializations of it.

Lemma 10.35 *We have the following.*

$$\dots \cong \dim(e_\pi)$$

(i) *We have the decomposition*

$$\bullet^i \cong \bigoplus_\pi \text{Im}(e_\pi) \quad (\text{in } \mathbf{TL}_{\mathbb{A}^\infty \oplus \mathbb{E}}^v).$$

(ii) *The object $\text{Im}(e_\pi) \in \mathbf{TL}_{\mathbb{A}^\infty \oplus \mathbb{E}}^v$ is simple.*

(iii) *We have*

$$(\text{Im}(e_\pi) \cong \text{Im}(e_{\pi'})) \Leftrightarrow (\pi \text{ and } \pi' \text{ are of the same weight}).$$



(iv) *We have*

$$\text{Si}(\mathbf{TL}_{\mathbb{A}^\infty \oplus \mathbb{E}}^v) = \text{In}(\mathbf{TL}_{\mathbb{A}^\infty \oplus \mathbb{E}}^v) = \{\text{Im}(e_\lambda) \mid \lambda \in \mathbb{N}\}.$$

Proof. (i)+(ii). These are direct consequences of Theorem 10.34.

(iii). If π and π' are not of the same weight, then $\text{Hom}_{\mathbf{TL}_{\mathbb{A}^\infty \oplus \mathbb{E}}^v}(\text{Im}(e_\pi), \text{Im}(e_{\pi'})) = 0$ by hom vanishing (10-9) and (10-15). Thus, we get $\text{Im}(e_\pi) \not\cong \text{Im}(e_{\pi'})$ in this case. For the converse it is enough to consider the case $e_{\pi'} = e_\lambda$. Then

$$\begin{array}{c} \tilde{d} \\ \hline \end{array} : \text{Im}(e_\pi) \rightarrow \text{Im}(e_\lambda) \quad \begin{array}{c} \tilde{u} \\ \hline \end{array} : \text{Im}(e_\lambda) \rightarrow \text{Im}(e_\pi),$$

are inverses up to a scalar as (10-15) shows

(iv). By (iii) we get that every $\text{Im}(e_\pi)$ is isomorphic to precisely one $\text{Im}(e_i)$, while (i) and (ii) show that there are no other simple objects. \square

Note that $\mathbf{TL}_{\mathbb{k} \oplus \mathbb{E}}^q$ is always 1 fiat. Moreover, it is 1 fusion in exactly the following situation:

Theorem 10.36 *Let (\mathbb{k}, q) be a specialization. Then $\mathbf{TL}_{\mathbb{k} \oplus \mathbb{E}}^q$ is semisimple if and only if $\mathbb{A}^\infty \subset_{v=q} \mathbb{k}$ (i.e. all quantum binomials are invertible). Moreover, in the semisimple case we have*

$$\text{Si}(\mathbf{TL}_{\mathbb{k} \oplus \mathbb{E}}^q) = \text{In}(\mathbf{TL}_{\mathbb{k} \oplus \mathbb{E}}^q) = \{\text{Im}(e_\lambda) \mid \lambda \in \mathbb{N}\}.$$

Proof. If all quantum binomials are invertible, then the specialization (\mathbb{k}, q) factors through \mathbb{A}^∞ and the claim follows from Lemma 10.35. On the other hand, if some quantum binomial is not invertible, then there exists some JW idempotent e_j which is still well-defined, but e_{j+1} is not.

Let e_i be the minimal such JW idempotent. We claim that $\text{Im}(e_i \otimes \text{id}_\bullet)$ is indecomposable, but not simple. Indeed,

$$\begin{array}{|c|} \hline e_i \\ \hline e_i \\ \hline \end{array} \Big| \stackrel{(10-6)}{=} \begin{array}{|c|} \hline e_i \\ \hline \end{array} \Big|$$

shows that $e_i \otimes \text{id}_\bullet$ is an idempotent. Moreover, using the standard basis (10-4) and (10-9) we have

$$\begin{array}{|c|} \hline e_i \\ \hline f \\ \hline e_i \\ \hline \end{array} = 0 \text{ unless } \begin{array}{|c|} \hline f \\ \hline \end{array} \in \left\{ \begin{array}{|c|} \hline \dots \\ \hline \end{array} \Big| \Big| \begin{array}{|c|} \hline \dots \\ \hline \end{array} \Big| \begin{array}{|c|} \hline \dots \\ \hline \end{array} \right\}.$$

← *invertible*

Furthermore, since \mathbb{k} is a field the quantum binomial $\begin{bmatrix} i+1 \\ j \end{bmatrix}_q$ for $0 \leq j \leq i+1$ is only non-invertible if its zero, which, by minimality of i , gives $[i+1]_q = 0$. Hence, the calculation

$$\begin{array}{|c|} \hline e_i \\ \hline \end{array} \stackrel{(10-11)}{=} \frac{[i+1]_q}{[i]_q} \begin{array}{|c|} \hline e_{i-1} \\ \hline \end{array} = 0$$

shows that the endomorphism ring of $\text{Im}(e_i \otimes \text{id}_\bullet)$ is $\mathbb{k}[X]/(X^2)$, which implies that $\text{Im}(\text{id}_\bullet \otimes e_i)$ is indeed indecomposable, not not simple. \square

10F. **Some quantum computations.** Let us further study the behavior of quantum numbers. Our main aim is to give “good” conditions for whether the JW idempotents and their generalizations exist, which implies that $\mathbf{TL}_{\mathbb{k} \oplus \mathbb{C}}^q$ is semisimple [Theorem 10.36](#). For a field \mathbb{k} this happens if and only if all quantum binomials are non-zero.

Definition 10.37 Define the q characteristic of a specialization (\mathbb{S}, q) as

$$\text{char}(\mathbb{S}, q) = \min \{ a \in \mathbb{N}_{>0} \mid [a]_q = 0 \},$$

or $\text{char}(\mathbb{S}, q) = 0$ if $[a]_q \neq 0$ for all $a \in \mathbb{N}_{>0}$.

$$[p] = [1 + \dots + 1] = 0$$

Example 10.38 For $q = \pm 1$ the q characteristic is the usual characteristic. Here are a few examples of the behavior of the quantum numbers, where $p = \text{char}(\mathbb{S})$.

	$[0]_q$	$[1]_q$	$[2]_q$	$[3]_q$	$[4]_q$	$[5]_q$	$[6]_q$	$[7]_q$	$[8]_q$
$q = 1, p = 0$	0	1	2	3	4	5	6	7	8
$q = -1, p = 0$	0	1	-2	3	-4	5	-6	7	-8
$q = 2, p = 0$	0	1	$\frac{5}{2}$	$\frac{21}{4}$	$\frac{85}{8}$	$\frac{341}{16}$	$\frac{1365}{32}$	$\frac{5461}{64}$	$\frac{21845}{128}$
$q = 1, p = 3$	0	1	2	\ominus	1	2	\ominus	1	2
$q = 1, p = 5$	0	1	2	3	4	\ominus	1	2	3
$q = 1, p = 7$	0	1	2	3	4	5	6	\ominus	1
$q = 2, p = 13$	0	1	9	2	9	1	\ominus	12	4
$q = 3, p = 13$	0	1	12	\ominus	1	12	\ominus	1	12
$q = 4, p = 13$	0	1	1	\ominus	12	12	\ominus	1	1

(The complex root of unity case was already discussed in [Example 9.34](#), so it is omitted from the above table.) Thus, we have for example $\text{char}(\mathbb{F}_{13}, 2) = 6$.

7

Lemma 10.39 Let $a \in \mathbb{Z}_{\neq 0}$. Then:

- (i) If $\text{char}(\mathbb{S}, q) = 0$, then $[a]_q \in \mathbb{S}$ is non-zero.

(ii) If $\text{char}(\mathbb{S}, q) = p > 0$ and $q = \pm 1$, then $[a]_q \in \mathbb{S}$ is non-zero if and only if $p \nmid a$.

(iii) If $\text{char}(\mathbb{S}, q) > 0$ and $q \neq \pm 1$, then $[a]_q \in \mathbb{S}$ is non-zero if and only if $q^{2a} \neq 1$.

Proof. If $q = \pm 1$, then we have $[a]_q = \pm a$ and the claims are clear. Note further that $[a]_q = q^a \frac{1-q^{2a}}{q-q^{-1}}$ in case $q \neq \pm 1$. Thus, the roots of $[a]_q$ are exactly the roots of the cyclotomic polynomial $1 - q^{2a}$, which proves the root of unity case. \square

For any $c \in \mathbb{N}$ and any $d \in \mathbb{N}$ we use the digits c_k of its d -adic expansion:

$$c = [\dots, c_2, c_1, c_0]_d = \sum_{k=0}^{\infty} c_k d^k \text{ where } c_k \in \{0, \dots, d-1\}.$$

We also write $*$ for an arbitrary digit.

Lemma 10.40 *Let $a \in \mathbb{N}$. Then:*

(i) If $\text{char}(\mathbb{S}, q) < a$, then $[a]_q \in \mathbb{S}$ is non-zero for all $0 \leq b \leq a$.

(ii) If $\text{char}(\mathbb{S}, q) = \text{char}(\mathbb{S}) = p \geq a$, then $[a]_q \in \mathbb{S}$ is non-zero for all $0 \leq b \leq a$ if and only if

$$a = [\dots, 0, 0, *, p-1, \dots, p-1]_p.$$

(iii) If $\text{char}(\mathbb{S}, q) = k \geq a$ and $\text{char}(\mathbb{S}) = 0$, then $[a]_q \in \mathbb{S}$ is non-zero for all $0 \leq b \leq a$ if and only if

$$a = [\dots, 0, 0, *, \dots, *, k-1]_k.$$

(iv) If $\text{char}(\mathbb{S}, q) = k \geq a$, $\text{char}(\mathbb{S}) = p > 0$ and $k \neq p$, then $[a]_q \in \mathbb{S}$ is non-zero for all $0 \leq b \leq a$ if and only if

$$a = [\dots, 0, 0, *, \dots, *, k-1]_k, \quad m = [\dots, 0, 0, *, p-1, \dots, p-1]_p,$$

where $a = mk + \tilde{a}_0$ for $0 \leq \tilde{a}_0 < k$.

Proof. In case $\text{char}(\mathbb{S}, q) < a$ the claim is clear, so let us assume that $\text{char}(\mathbb{S}, q) = k \geq a$ and write $a = mk + \tilde{a}_0$ and $b = nk + \tilde{b}_0$ with $0 \leq \tilde{a}_0, \tilde{b}_0 < k$. Recall that then the **quantum Lucas' theorem** states that

$$(10-17) \quad \begin{bmatrix} a \\ b \end{bmatrix}_q = \binom{m}{n} \begin{bmatrix} \tilde{a}_0 \\ \tilde{b}_0 \end{bmatrix}_q,$$

see e.g. [Lu10, Lemma 24.1.2]. Note the appearance of the usual binomial: If $\text{char}(\mathbb{S}) = 0$, then this factor is always non-zero and we get the case (iii) in the statement. If however $\text{char}(\mathbb{S}) = p > 0$, then we can apply the classical Lucas theorem to (10-17) and get

$$\begin{bmatrix} a \\ b \end{bmatrix}_q = \left(\prod_{i=0}^{\infty} \binom{m_i}{n_i} \right) \begin{bmatrix} \tilde{a}_0 \\ \tilde{b}_0 \end{bmatrix}_q \stackrel{p=l}{=} \prod_{i=0}^{\infty} \binom{a_i}{b_i} \begin{bmatrix} a_0 \\ b_0 \end{bmatrix}_q.$$

where we distinguish expansion in base l and p . \square

Example 10.41 *If we want to know whether $[a]_q$ is non-zero for all $0 \leq b \leq a$, as in Example 10.19 for $a = 8$, $a = 11$ or $a = 14$, then:*

- Generically this is always the case.

$a_0 p^0$

$$a = [a_v, \dots, a_0]$$

$$b = [b_v, \dots, a_0]$$

$a_k \in \{0, 1, \dots, p-1\}$

- In char p we would write e.g. $8 = [2, 2]_3 = [1, 3]_5 = [1, 1]_7$ which implies that in characteristic 3 the quantum binomials will be non-zero, but it will eventually be zero in characteristic 5 or 7. For $11 = [1, 0, 2]_3$ the quantum binomial might be zero.
- In the complex root of unity case only the zeroth digit plays a role. For example for $11 = [1, 0, 2]_3$ and $q = \exp(2\pi i/3)$ the quantum binomial will always be non-zero.
- The mixed case is a mixture of the above two cases. For example, for $q^3 = 1$ and $p = 7$ one would need to expand a in base 3, where only the zeroth digit is important, and then m in base 7, cf. $14 = [1, 1, 2]_3$ and $4 = [4]_7$ in [Example 10.19](#). Another example where all quantum binomials for $q^3 = 1$ and $p = 7$ are invertible is $146 = 3 \cdot 48 + 2$ since $146 = [1, 2, 1, 0, 2]_3$ and $48 = [6, 6]_7$.

For [Lemma 10.40](#) and [Theorem 10.36](#) we immediately get:

Theorem 10.42 *Let (\mathbb{k}, q) be a specialization. Then $\mathbf{TL}_{\mathbb{k} \oplus \mathbb{C}}^q$ is semisimple if and only if we are in the generic case. Moreover, in this case we have*

$$\text{Si}(\mathbf{TL}_{\mathbb{k} \oplus \mathbb{C}}^q) = \text{In}(\mathbf{TL}_{\mathbb{k} \oplus \mathbb{C}}^q) = \{ \text{Im}(e_\lambda) \mid \lambda \in \mathbb{N} \},$$

as the set of simple objects. □

10G. **Constructing Verlinde categories.** Let us now finish by constructing quantum invariants from (specializations of) $\mathbf{TL}_{\mathbb{A} \oplus \mathbb{C}}^v$.

Definition 10.43 *Let $\mathbf{C} \in \mathbf{MCat}$. We call a collection of subspaces*

$$\mathbf{I}_\otimes = \{ \text{In}(X, Y) \subset \text{Hom}_{\mathbf{C}}(X, Y) \mid X, Y \in \mathbf{C} \}$$

a (two-sided) \otimes ideal if

- it is closed under vertical composition, i.e.

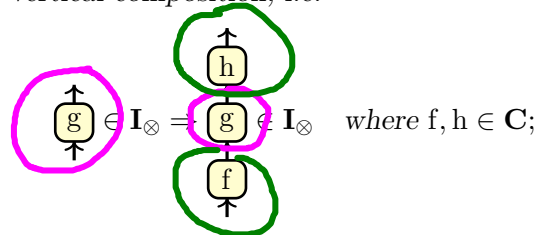

- it is closed under horizontal composition, i.e.

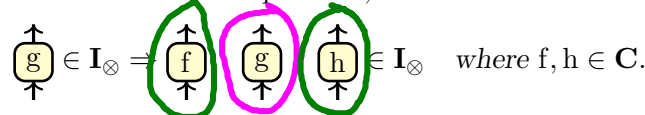

Proposition 10.44 *Let $\mathbf{C} \in \mathbf{MCat}_{\mathbb{S}}$ and let \mathbf{I}_\otimes be a \otimes ideal. Then:*

- (i) *There exists a category $\mathbf{C}/\mathbf{I}_\otimes$ with*

$$\text{Ob}(\mathbf{C}/\mathbf{I}_\otimes) = \text{Ob}(\mathbf{C}), \quad \text{Hom}_{\mathbf{C}/\mathbf{I}_\otimes}(X, Y) = \text{Hom}_{\mathbf{C}}(X, Y)/\text{In}(X, Y),$$

and the evident composition.

- (ii) *We have $\mathbf{C}/\mathbf{I}_\otimes \in \mathbf{MCat}$ and the identity map on objects and morphisms induces a monoidal and full functor $\mathbf{C} \rightarrow \mathbf{C}/\mathbf{I}_\otimes$.*

(iii) If \mathbf{C} was braided (or rigid, pivotal, spherical, ribbon), then so is $\mathbf{C}/\mathbf{I}_\otimes$.

Proof. This is Exercise 10.54. □

Example 10.45 Clearly, any $\mathbf{C} \in \mathbf{MCat}_S$ has a trivial \otimes ideal, namely $\mathbf{I}_\otimes = \mathbf{C}$. We stress this because of the confusing fact that \mathbf{C}/\mathbf{C} is trivial although $\text{Ob}(\mathbf{C}/\mathbf{C}) = \text{Ob}(\mathbf{C})$. The point is that $\text{Hom}_{\mathbf{C}/\mathbf{C}}(X, Y) \cong \{0\}$, and thus all objects are isomorphic.

Definition 10.46 Let $\mathbf{C} \in \mathbf{PCat}_S$. A morphism $f \in \mathbf{C}$ is called right negligible if

$$\text{tr}^{\mathbf{C}}(gf) = 0 \text{ for all } g \in \mathbf{C},$$

and left negligible if

$${}^{\mathbf{C}}\text{tr}(gf) = 0 \text{ for all } g \in \mathbf{C}.$$

A right and left negligible is called negligible.

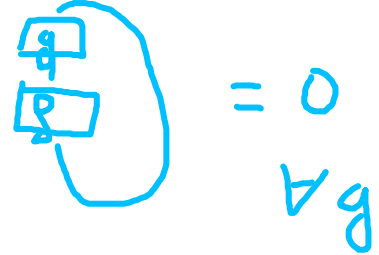

For $\mathbf{C} \in \mathbf{PCat}_S$ let $\mathbf{N}_{\mathbf{C}}$ denote the collection of negligible morphisms.

Proposition 10.47 For any $\mathbf{C} \in \mathbf{PCat}_S$ collection $\mathbf{N}_{\mathbf{C}}$ is a \otimes ideal.

Proof. By definition, the vertical composition of a negligible morphism with any other morphism is negligible. Moreover, up to symmetry,

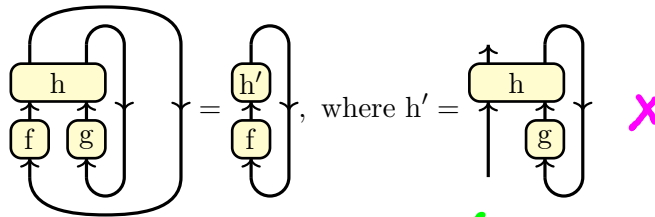

shows the same for the horizontal composition.

not semisimple □

Definition 10.48 Fix the canonical pivotal structure on $\mathbf{TL}_{\mathbb{A} \oplus \mathbb{E}}$. For any specialization (S, q) we call

$$\mathbf{Ver}(S, q) = \mathbf{TL}_{S \oplus \mathbb{E}}^q / \mathbf{N}_{\mathbf{TL}_{S \oplus \mathbb{E}}^q}$$

the Verlinda category for (S, q) .

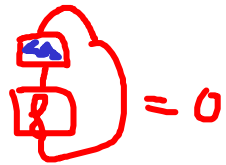

Example 10.49 In the generic case $\mathbf{Ver}(\mathbb{k}, q) = \mathbf{TL}_{\mathbb{k} \oplus \mathbb{E}}^q$, since $\mathbf{N}_{\mathbf{TL}_{\mathbb{k} \oplus \mathbb{E}}^q} = 0$. This follows because we know that the (images of the) JW idempotents are the simple objects in this semisimple category, see Theorem 10.42, and their traces are non-zero by Lemma 10.25.

By Proposition 10.44.(iii) and additivity of categorical traces we immediately see that $\mathbf{Ver}(S, q) \in \mathbf{IRifiat}$. We get a bit more:

Proposition 10.50 For any specialization (\mathbb{k}, q) the category $\mathbf{Ver}(\mathbb{k}, q)$ is semisimple, i.e. $\mathbf{Ver}(\mathbb{k}, q) \in \mathbf{IRiMo}$. Furthermore, the simple objects of $\mathbf{Ver}(\mathbb{k}, q)$ are the indecomposable objects of $\mathbf{TL}_{\mathbb{k} \oplus \mathbb{E}}^q$ of non-zero categorical dimension.

get rid of level stuff

Proof. This follows from the following characterization of negligible morphisms. A morphism $f = (f_{i,j}): \bigoplus_{i=1}^k Z_i \rightarrow \bigoplus_{j=1}^l Z_j$ between indecomposable objects of $\mathbf{Ver}(\mathbb{k}, q)$ is negligible if and only if for each i, j either $f_{i,j}$ is not an isomorphism or $\dim^{\mathbf{Ver}(\mathbb{k}, q)}(Z_j) = 0$. (This is well-known, see e.g. [EO18, Lemma 2.2].) \square

The Verlinde categories are sometimes even modular, e.g. in the complex root of unity case. In general:

The quantum invariants arising from $\mathbf{Ver}(\mathbb{k}, q)$ are generalized Jones polynomials.

This gives a completely diagrammatic construction of the Jones-type quantum invariants, i.e. by coloring strands with (versions of) JW idempotents. Similarly one can construct type BCD versions of these invariants using quantum Brauer categories, or higher rank versions using so-called webs.

10H. Exercises.

Exercise 10.51 Prove Lemma 10.16.

Exercise 10.52 Prove Lemma 10.17. Also try to think what changes in the proof compared to Lemma 10.31.

Exercise 10.53 Prove Lemma 10.25.

Exercise 10.54 Prove Proposition 10.44.

Exercise 10.55 Compute the following quantum invariant.

$$\beta_{L_i, L_i}^3 = \begin{array}{c} L_i \quad L_i \\ \uparrow \quad \uparrow \\ \text{---} \text{---} \\ \downarrow \quad \downarrow \\ L_i \quad L_i \end{array}, \quad \text{tr}^{\mathbf{Ver}(\mathbb{k}, \exp(\pi i/3))}(\beta_{L_i, L_i}^3) = \begin{array}{c} \text{---} \\ \uparrow \quad \uparrow \\ \text{---} \text{---} \\ \downarrow \quad \downarrow \\ \text{---} \\ L_i \quad L_i \end{array} \in \mathbb{C},$$

for $i = 0, 1, 2$. (This is the colored Jones polynomial of the trefoil knot.)

REFERENCES

[An92] H.H. Andersen. *Tensor Products of Quantized Tilting Modules*. Commun. Math. Phys. 149 (1992), 149–159.

[BS11] J. Baez, M. Stay. *Physics, Topology, Logic and Computation: A Rosetta Stone*. New structures for physics, 95–172, Lecture Notes in Phys., 813, Springer, Heidelberg, 2011. <https://arxiv.org/abs/0903.0340>

[BK01] B. Bakalov, A. Kirillov Jr. *Lectures on tensor categories and modular functors*. University Lecture Series, 21. American Mathematical Society, Providence, RI, 2001.

[Ba74] M. Barr. *Toposes without points*. J. Pure Appl. Algebra, Volume 5, Issue 3, 1974, 265–280.

[BW99] J.W. Barrett, B.W. Westbury. *Spherical categories*. Adv. Math. 143 (1999), 357–375. <https://arxiv.org/abs/hep-th/9310164>

[Be91] D.J. Benson. *Representations and Cohomology. Volume 1: Basic Representation Theory of Finite Groups and Associative Algebras*. Cambridge University Press, 1991.

[CP95] V. Chari, A.N. Pressley. *A guide to quantum groups*. Cambridge University Press, Reprint edition October 27, 1995.

[El15] B. Elias. *Light ladders and clasp conjectures*. <https://arxiv.org/abs/1510.06840>

- [EL17] B. Elias, N. Libedinsky. (With an appendix by B. Webster.) *Soergel bimodules for universal Coxeter groups*. Trans. Amer. Math. Soc. 369:6 (2017), 3883–3910. <https://arxiv.org/abs/1401.2467>
- [EGNO15] P. Etingof, S. Gelaki, D. Nikshych, V. Ostrik. *Tensor categories*. Mathematical Surveys and Monographs 205. American Mathematical Society, Providence, RI, 2015. <http://www-math.mit.edu/~etingof/egnobookfinal.pdf>
- [ENO05] P. Etingof, D. Nikshych, V. Ostrik. *On fusion categories*. Ann. of Math. (2) 162 (2005), no. 2, 581–642. <https://arxiv.org/abs/math/0203060>
- [EO18] P. Etingof, V. Ostrik. *On semisimplification of tensor categories*. <https://arxiv.org/abs/1801.04409>
- [Fr64] P. Freyd. *Abelian categories: an introduction to the theory of functors*. Harper & Row, 1964, 1964.
- [Fr65] P. Freyd. *Representations in abelian categories*. Proc. Conf. Categorical Algebra, La Jolla, Calif., (1965), Springer, New York, 1966, pp. 95–120.
- [FK93] J. Fröhlich, T. Kerler. *Quantum groups, quantum categories and quantum field theory*. Volume 1542 of Lecture Notes in Mathematics. Springer-Verlag, Berlin, 1993.
- [HH09] T.J. Hagge, S.-M. Hong. *Some non-braided fusion categories of rank three*. Commun. Contemp. Math. 11 (2009), no. 4, 615–637. <https://arxiv.org/abs/0704.0208>
- [HV19] C. Heunen, J. Vicary. *Categories for Quantum Theory: An Introduction*. Oxford Graduate Texts in Mathematics, 28. Oxford University Press, Oxford, 2019. xii+336 pp. Comes close: <http://www.cs.ox.ac.uk/people/jamie.vicary/IntroductionToCategoricalQuantumMechanics.pdf>
- [Hi53] D.G. Higman. *Indecomposable representations at characteristic p* . Duke Math. J., Volume 21, Number 2 (1954), 377–381.
- [JS93] A. Joyal, R. Street. *Braided tensor categories*. Adv. Math. 102 (1993), 20–78.
- [Ka93] M.M. Kapranov. *The permutoassociahedron, Mac Lane’s coherence theorem and asymptotic zones for the KZ equation*. J. Pure Appl. Algebra, 85(2):119–142, 1993.
- [KT08] C. Kassel, V. Turaev. *Braid Groups. With the graphical assistance of Olivier Dodane*. Graduate Texts in Mathematics 247, Springer, New York, 2008.
- [Lu10] G. Lusztig. *Introduction to quantum groups*. Modern Birkhäuser Classics. Birkhäuser/Springer, New York, 2010. Reprint of the 1994 edition.
- [Ma98] S. Mac Lane. *Categories for the working mathematician*. Second edition. Graduate Texts in Mathematics, 5. Springer-Verlag, New York, 1998.
- [Ma94] S. Majid. *Algebras and Hopf Algebras in Braided Categories*. Advances in Hopf Algebras, Marcel Dekker. Lec. Notes Pure and Applied Maths 158 (1994) 55–105. <https://arxiv.org/abs/q-alg/9509023>
- [NS07] S.-H. Ng, P. Schauenburg. *Higher Frobenius-Schur Indicators for Pivotal Categories*. In: Hopf Algebras and Generalizations. Contemp. Math., Vol. 441, Providence, RI: Amer. Math. Soc., 2007, pp. 63–90. <https://arxiv.org/abs/math/0503167>
- [Os03] V. Ostrik. *Fusion categories of rank 2*. Math. Res. Lett. 10 (2003), no. 2-3, 177–183. <https://arxiv.org/abs/math/0203255>
- [Os13] V. Ostrik. *Pivotal fusion categories of rank 3*. <https://arxiv.org/abs/1309.4822>
- [TY98] D. Tambara, S. Yamagami. *Tensor categories with fusion rules of self-duality for finite abelian groups*. J. Algebra 209 (1998), no. 2, 692–707.
- [TV17] V. Turaev, A. Virelizier. *Monoidal categories and topological field theory*. Progress in Mathematics, 322. Birkhäuser/Springer, Cham, 2017.

D.T.: INSTITUT FÜR MATHEMATIK, UNIVERSITÄT ZÜRICH, WINTERTHURERSTRASSE 190, CAMPUS IRCHEL, OFFICE Y27J32, CH-8057 ZÜRICH, SWITZERLAND, WWW.DTUBBENHAUER.COM

Email address: daniel.tubbenhauer@math.uzh.ch